



Manufacturers & Exporters of Dental, surgical & Beauty Instruments



# DENTAL

Instruments Catalogue

















# Table Of Contents





## Table of Contents



|           |  |         |   |
|-----------|--|---------|---|
| <b>01</b> | Tooth Extracting Forceps   | 01-49   |    |
| <b>02</b> | Root Elevators   | 50-70   |    |
| <b>03</b> | Scalpel Handles, Handles, Mouth Mirrors<br>Scalers, Explorer / Probes                        | 71-85   |    |
| <b>04</b> | Endodontic Condensers, Obturation Instruments<br>Excavators, Explorer / Probes, Curette Sets | 86-96   |  |
| <b>05</b> | Amalgam Pluggers / Condensers, Burnishers  | 97-100  |  |
| <b>06</b> | Wax Carvers, Carvers, Chisels  | 101-103 |  |
| <b>07</b> | Compote Placement, Plastic Filling Instruments   | 104-107 |  |
| <b>08</b> | Curettes, Gracey Curettes, Dental Products, Knives   | 108-117 |  |
| <b>09</b> | Wax Porcelain & Cement Instruments<br>Wax & Modeling Instruments                             | 118-121 |  |
| <b>10</b> | Spatulas, Cement Spatulas  | 122-124 |  |
| <b>11</b> | Files, Hoes, Knives, Wax & Plaster Knives,<br>Crane Kaplan                                   | 125-128 |  |
| <b>12</b> | Bone Curettes, Bone Files, Bone Chisels,<br>Bone Mallets                                     | 129-133 |  |
| <b>13</b> | Crown Removers, Crown Instruments  | 134-136 |  |



|           |   |         |  |
|-----------|---|---------|--|
| <b>14</b> | Implants & Measuring Instruments, Suction Tubes, Bone Gauges                                    | 137-144 |  |
| <b>15</b> | Amalgam Guns & Carriers, Retainers, Bands, Strip Holders, Napkin Holders                        | 145-146 |  |
| <b>16</b> | Rubber Dam Instruments, Rubber Dam Clamps   | 147-148 |  |
| <b>17</b> | Syringes, Tweezers, Sterilizing & Lab Instruments   | 149-156 |  |
| <b>18</b> | Endodontic Forceps, Tissue Forceps, Haemostatic Forceps, Towel Clamps                           | 157-159 |  |
| <b>19</b> | Retractors, Lip & Cheek Retractors, Hooks, Depressors & Mouth Gags, Sterilizing Forceps         | 160-164 |  |
| <b>20</b> | Orthodontic Pliers & Cutters, Rongeurs  | 165-179 |  |
| <b>21</b> | Needle Holders, Scissors, Micro Surgery Set   | 180-186 |  |
| <b>22</b> | Impression Trays  | 187-193 |  |
| <b>23</b> | Articulators, Hollow Wares  | 194-200 |  |
| <b>24</b> | Scissors, Dissecting Forceps, Needle Holders, Wire Cutting Pliers With Tungsten Carbide Inserts | 201-213 |  |
| <b>25</b> | Dental Implants Instruments   | 214-216 |  |
| <b>26</b> | Dental Instruments Sets   | 217     |  |

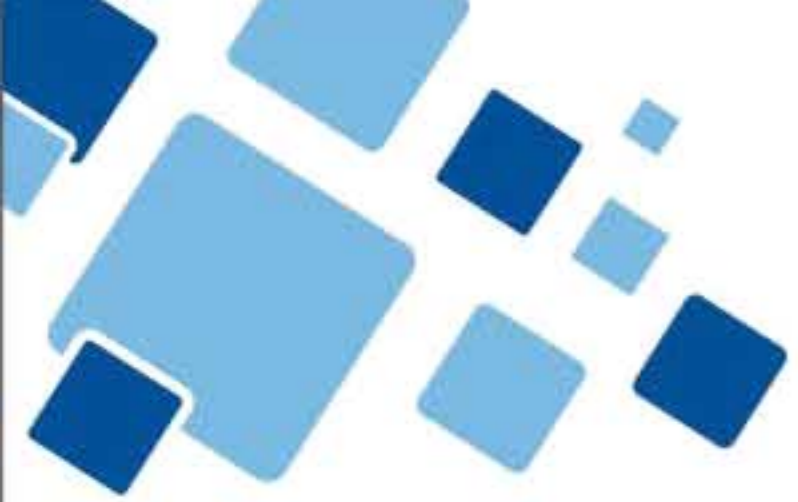

- ⟨☞⟩ Extracting Forceps
- ⟨☞⟩ Root Elevators



# 01

SECTION





**1001**  
Fig. 4  
lower incisor



**1001**  
Fig. 4  
lower incisor



**1002**  
Fig. 8  
lower premolar



**1002**  
Fig. 8  
lower premolars



**1003**  
Fig. 1  
upper centrals & canines



**1004**  
Fig. 2  
upper laterals & canines



**1005**  
Fig. 3  
upper incisors & canines



**1006**  
Fig. 4  
upper incisors & canines

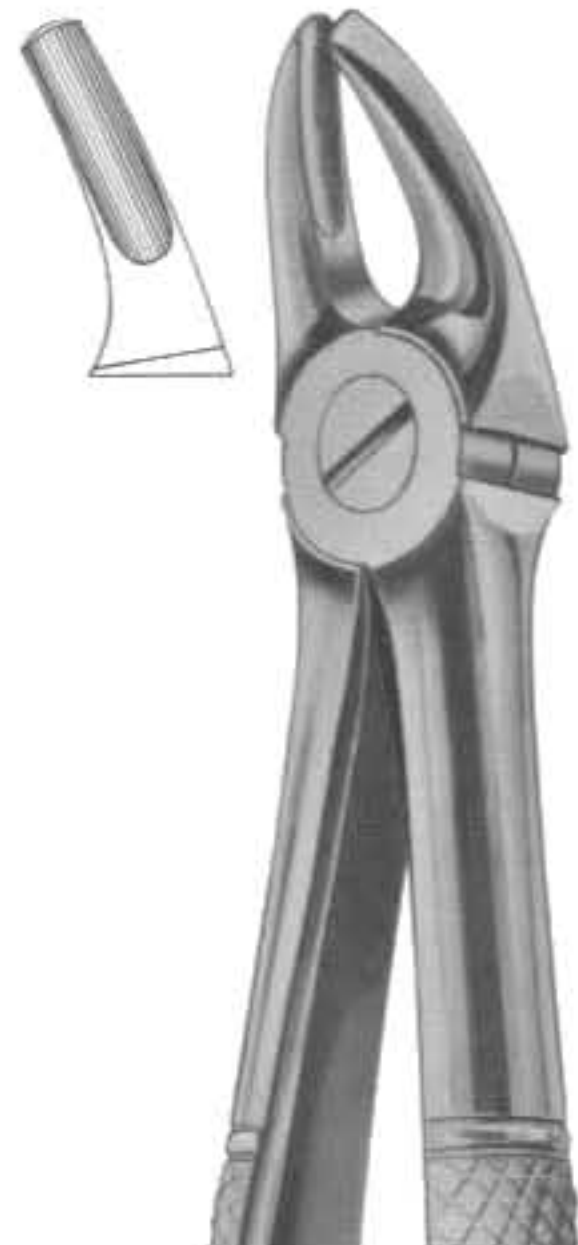

**1007**  
Fig. 7  
upper premolars



**1008**  
Fig. 8  
lower premolars



**1009**  
Fig. 13  
lower premolars



**1010**  
Fig. 13S  
lower premolars  
for children.

**1011**  
Fig. 17  
upper molars, right

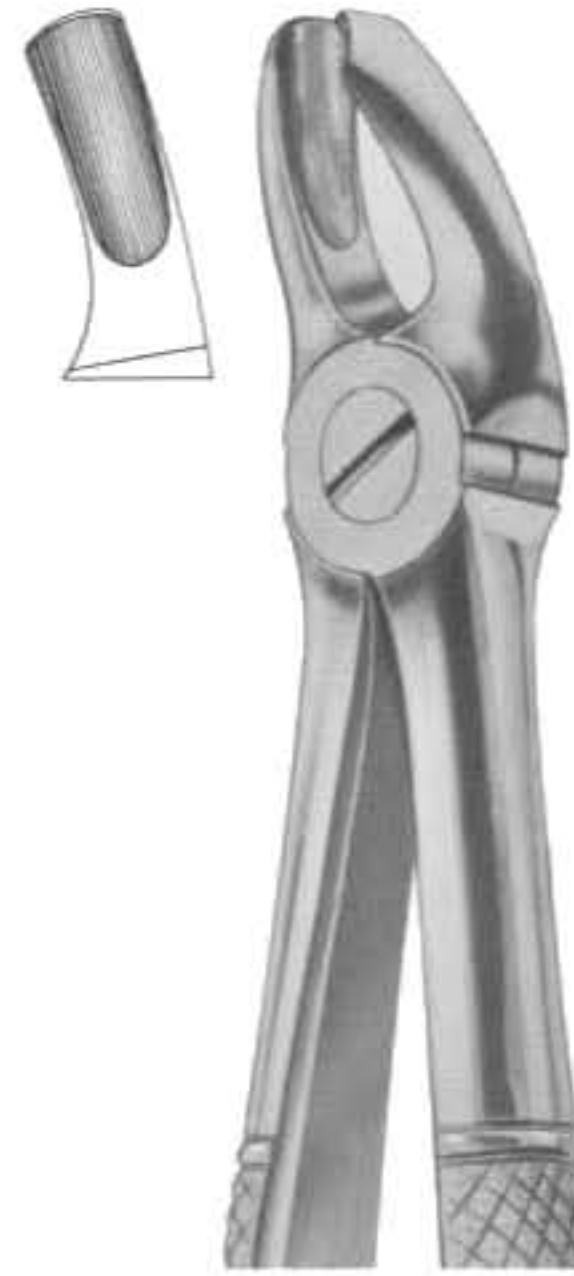

**1012**  
Fig. 18  
upper molars, left

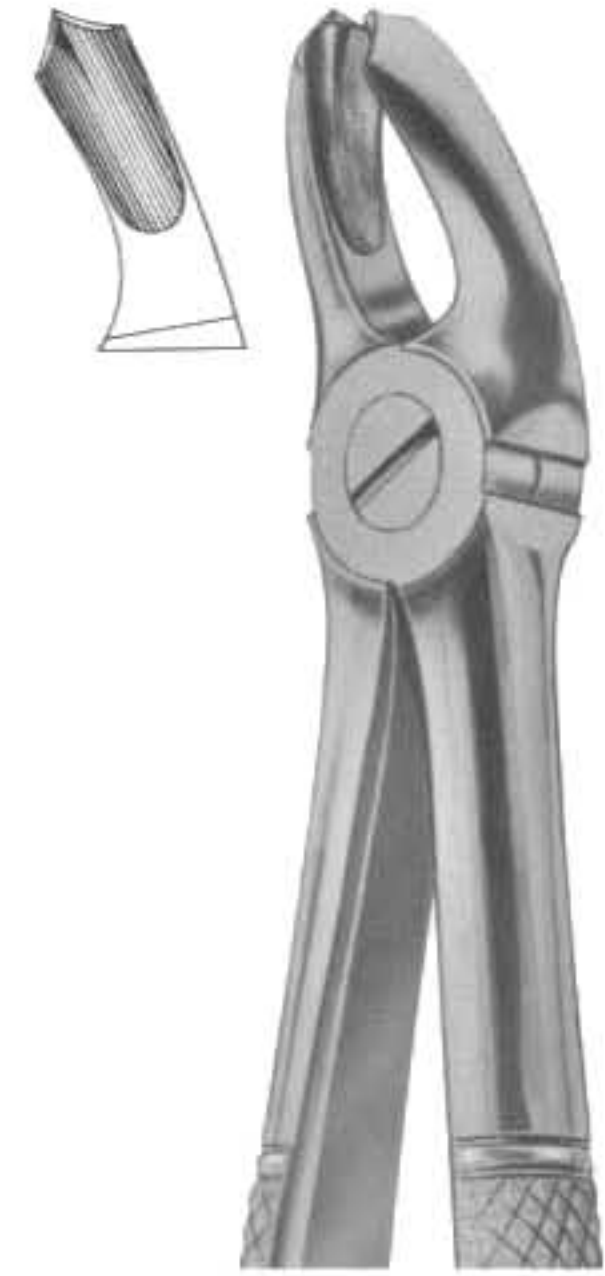

**1013**  
Fig. 18A  
upper molars

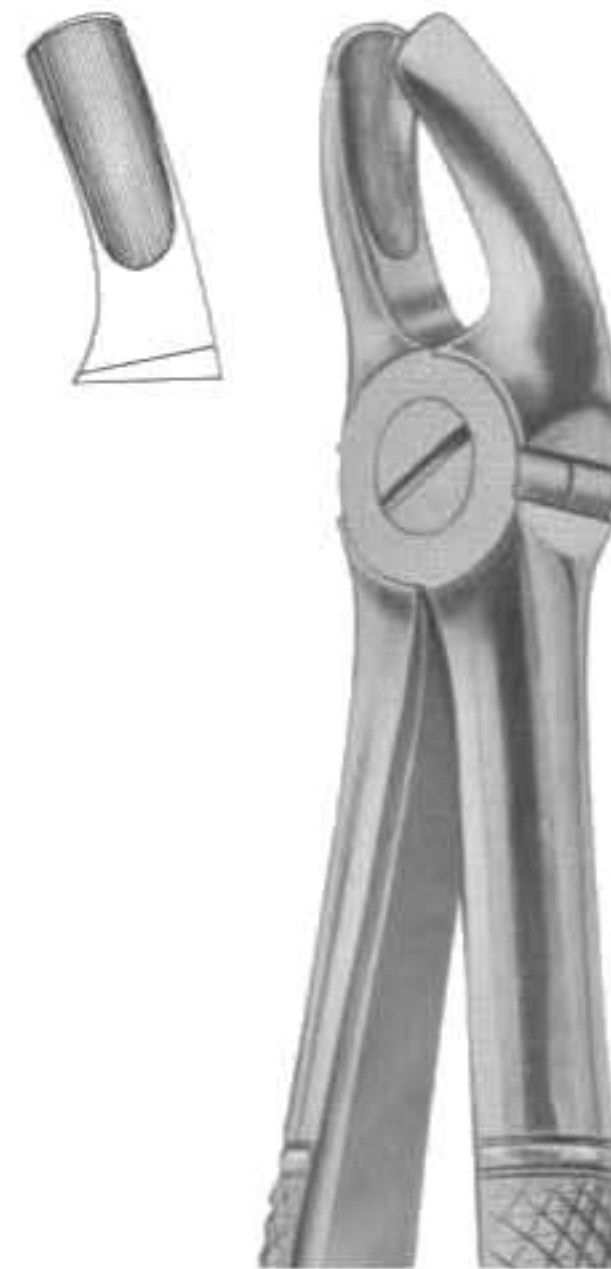

**1014**  
Fig. 18B  
upper molars



**1015**  
Fig. 19  
upper third molars





**1016**  
Fig. 20  
upper third molars

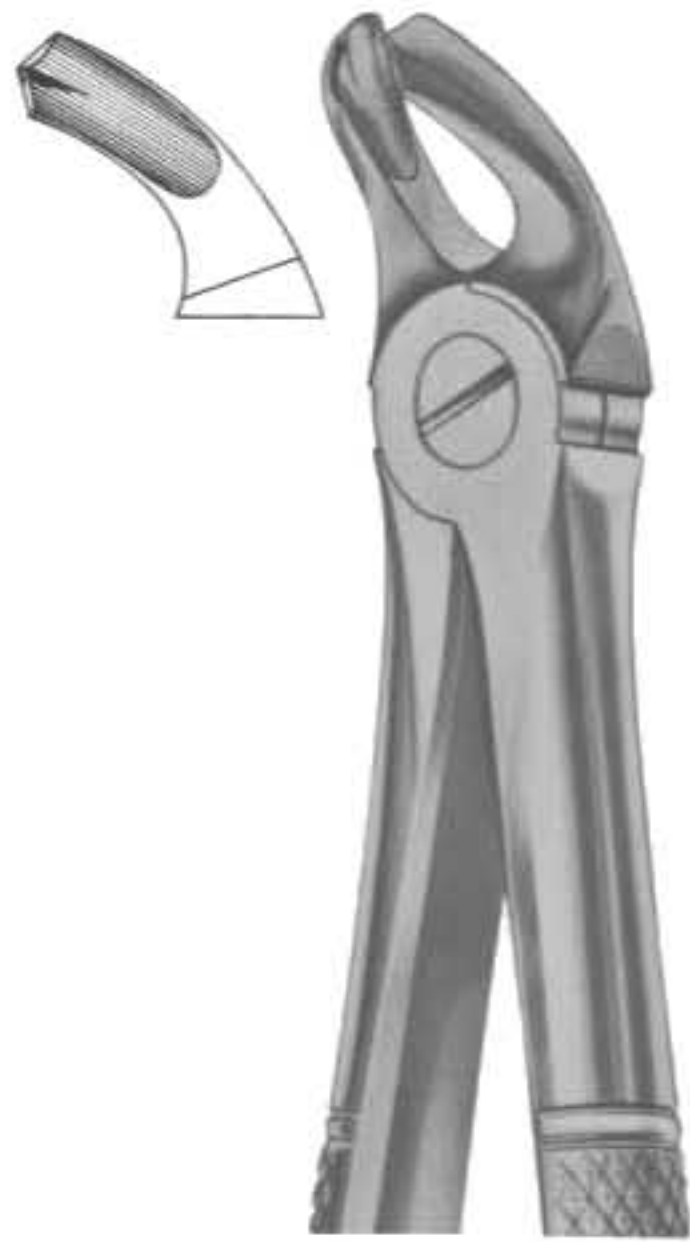

**1017**  
Fig. 21  
lower molars

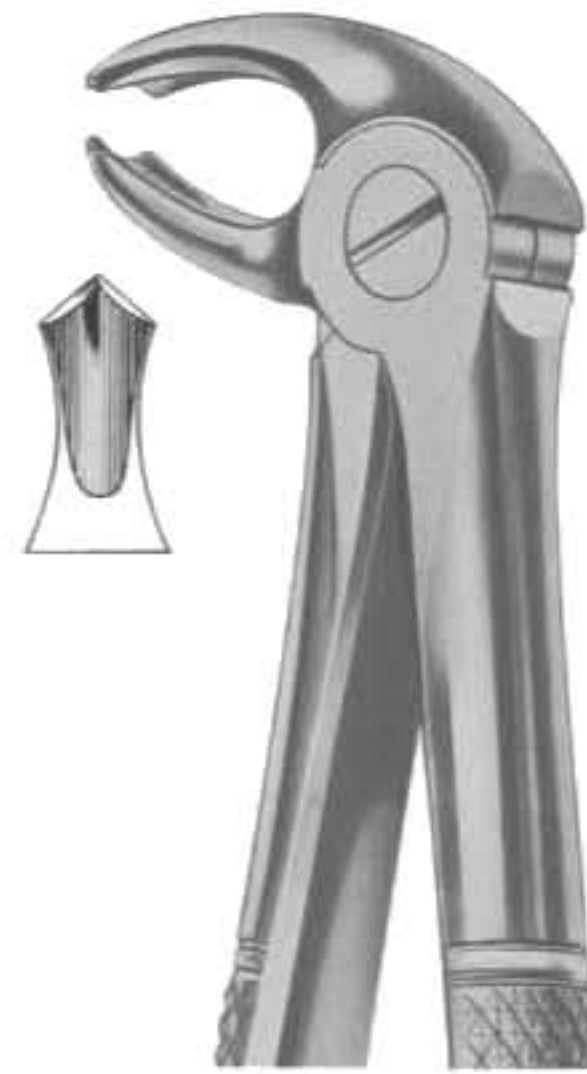

**1018**  
Fig. 22  
lower molars

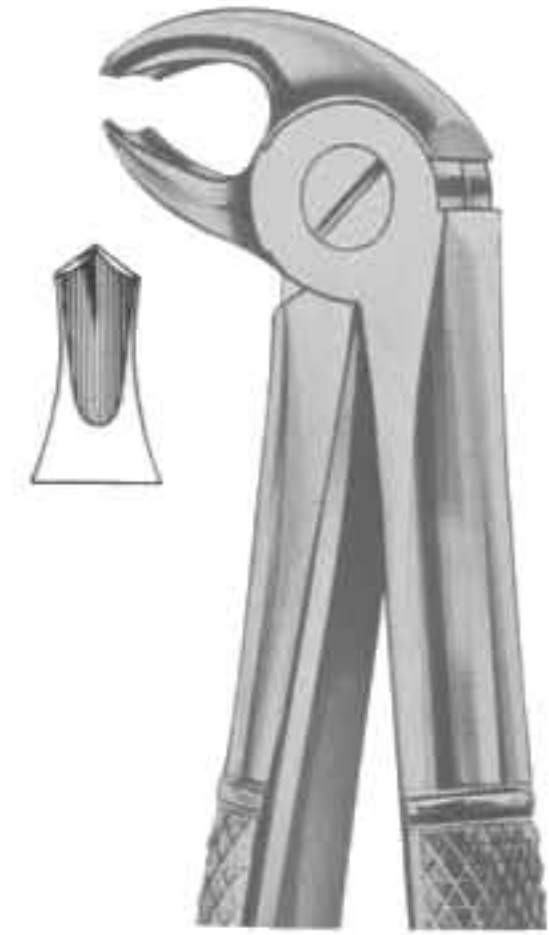

**1019**  
Fig. 22S  
lower molars  
for children

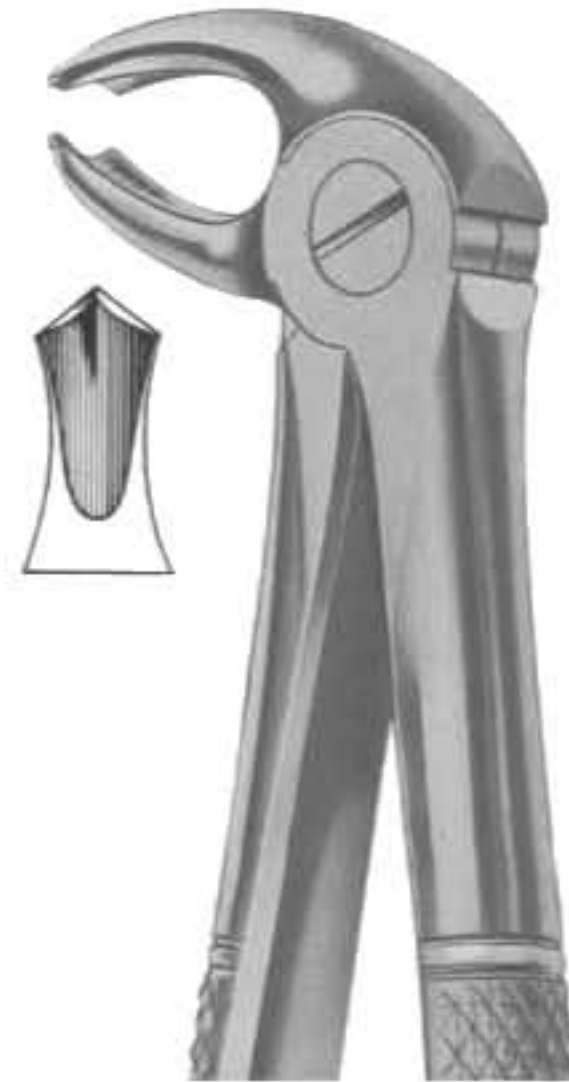

**1020**  
Fig. 22G  
lower molars

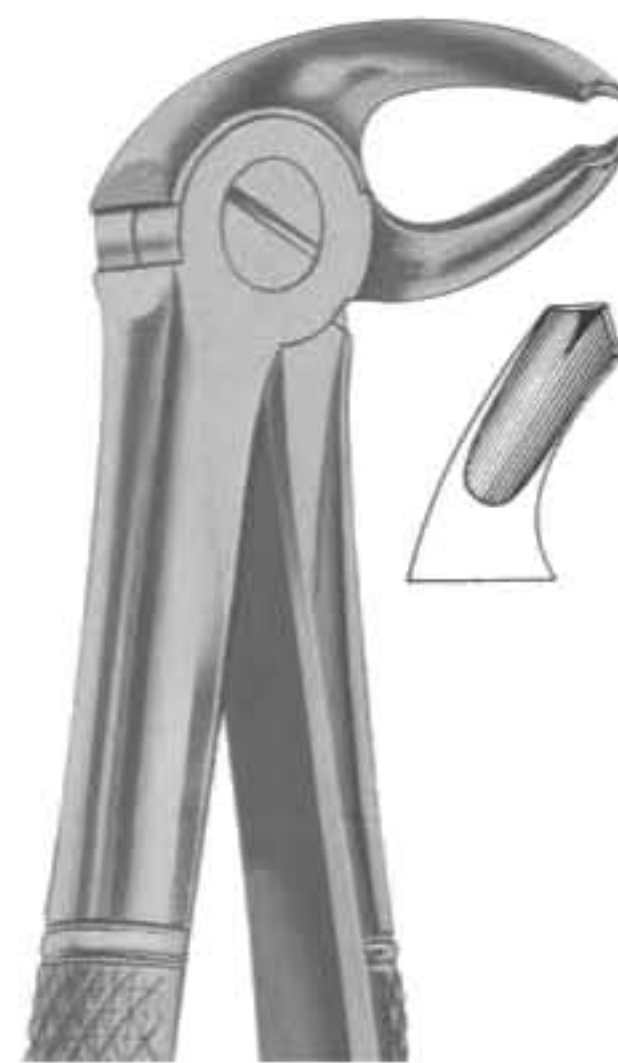

**1021**  
Fig. 23  
lower molars right

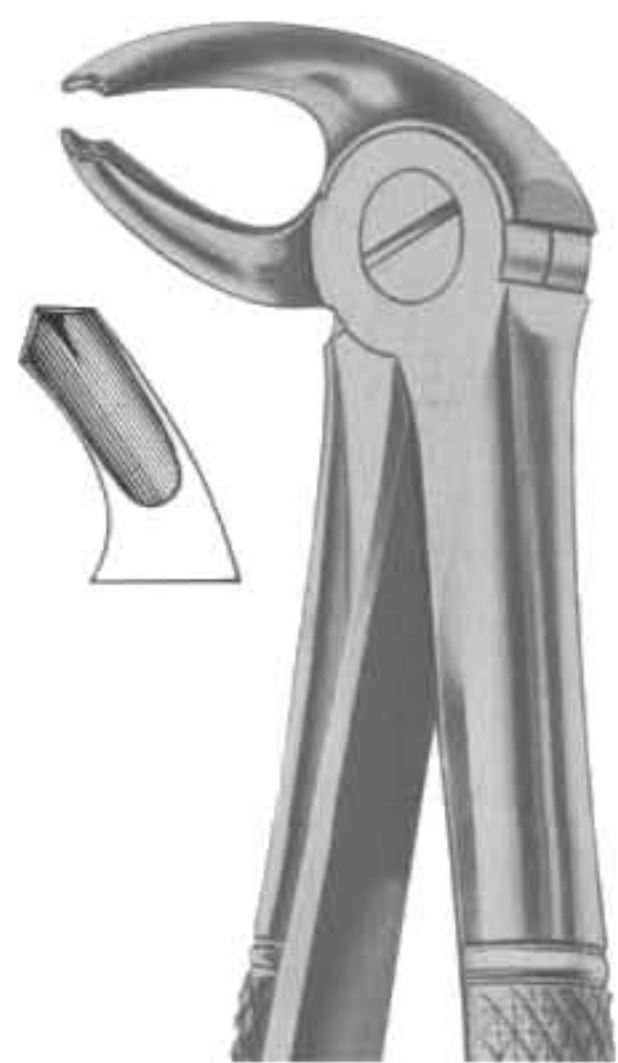

**1022**  
Fig. 24  
lower molars left





**1023**  
Fig. 29  
upper roots



**1024**  
Fig. 29S  
upper roots for children



**1025**  
Fig. 30  
upper roots

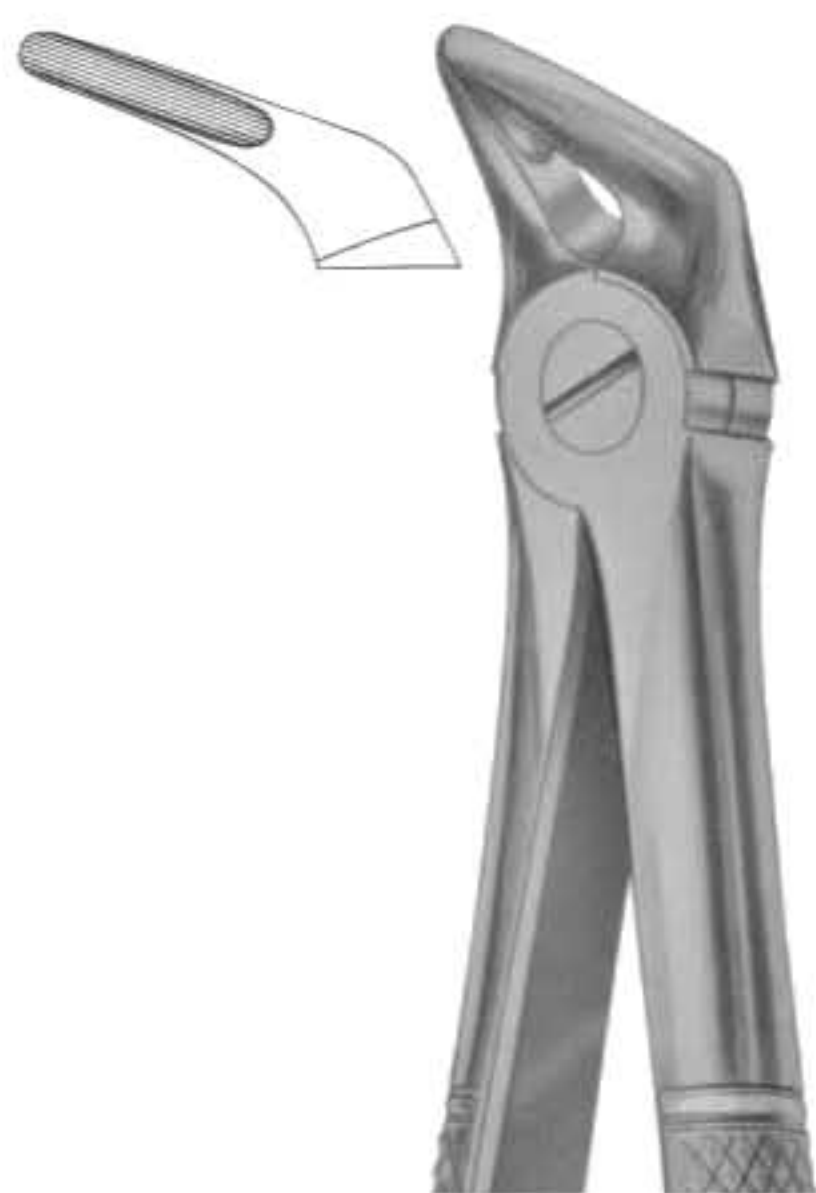

**1026**  
Fig. 31  
lower roots



**1027**  
Fig. 32  
lower molars



**1028**  
Fig. 30S  
upper roots  
for children



**1029**  
Fig. 33  
lower roots

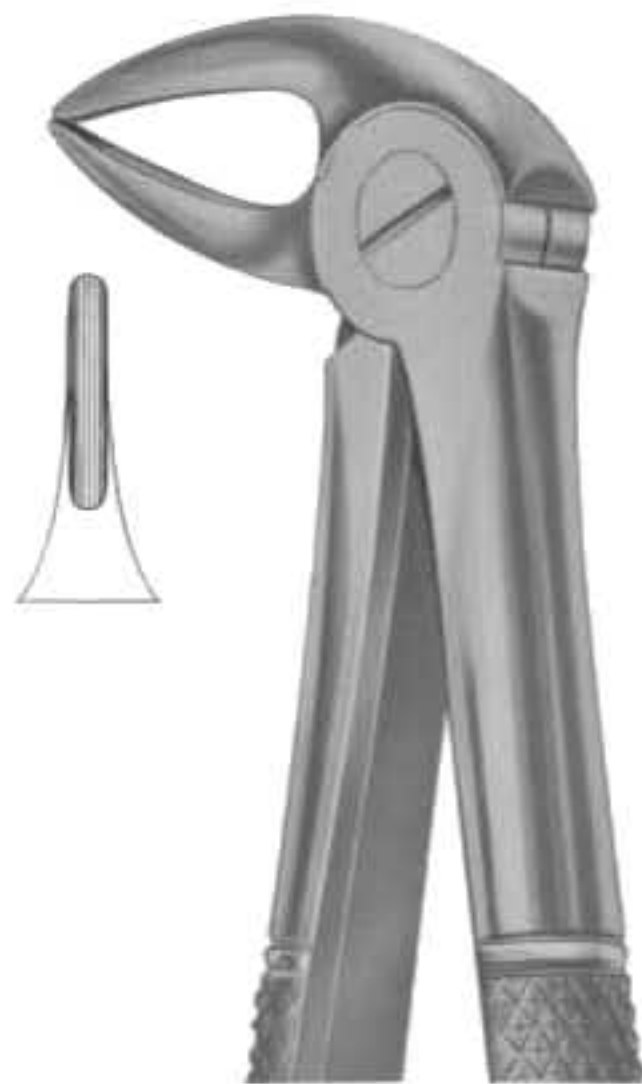

**1030**  
Fig. 33A  
lower roots

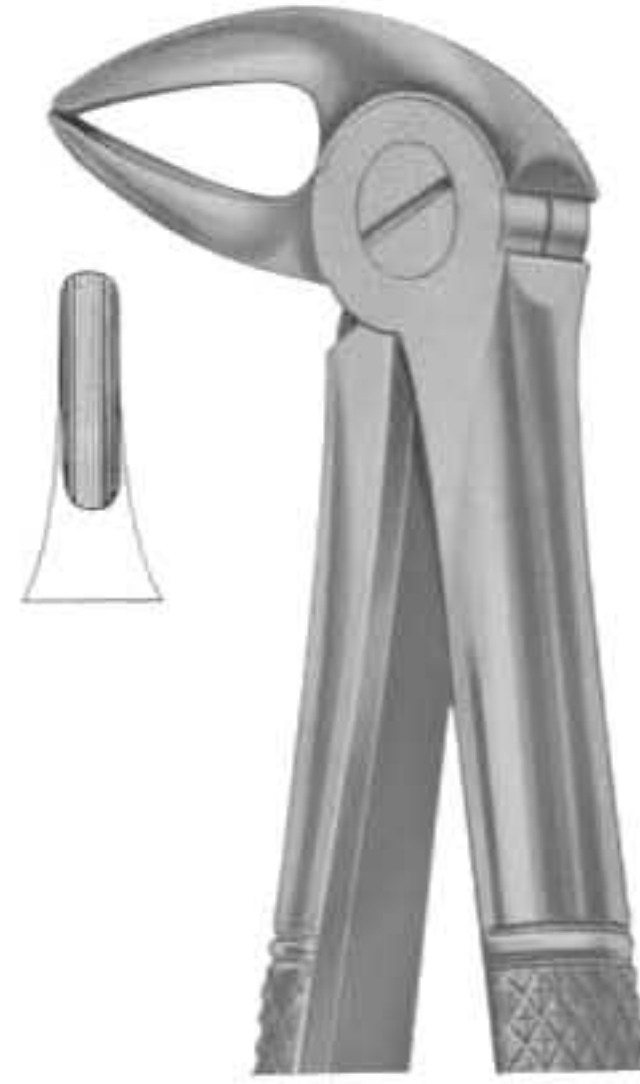

**1031**  
Fig. 33B  
lower roots

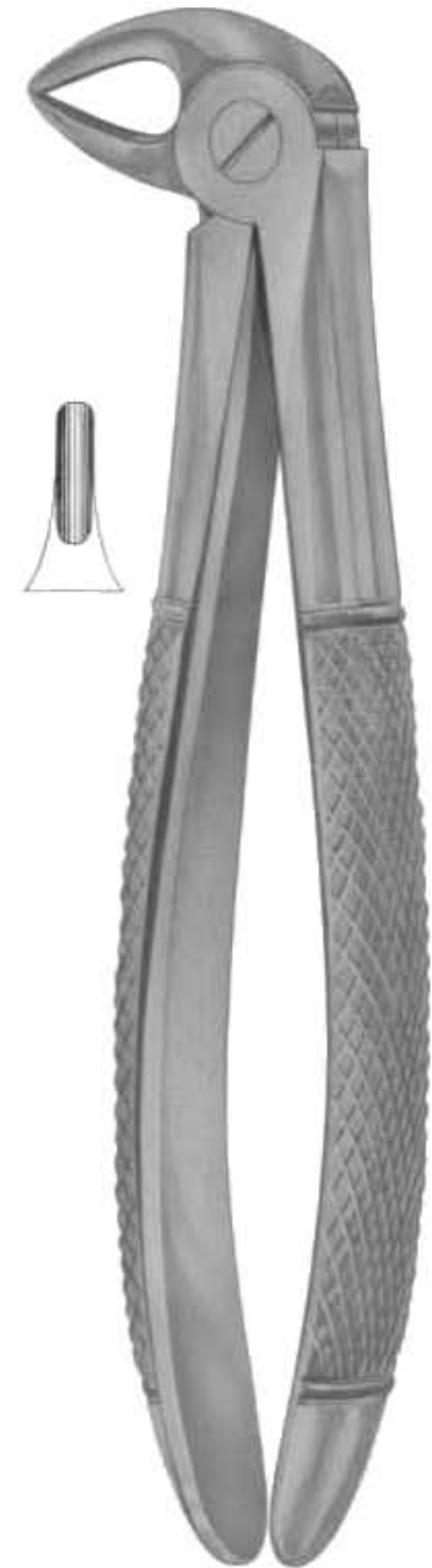

**1034**  
Fig. 33S  
lower roots  
for children

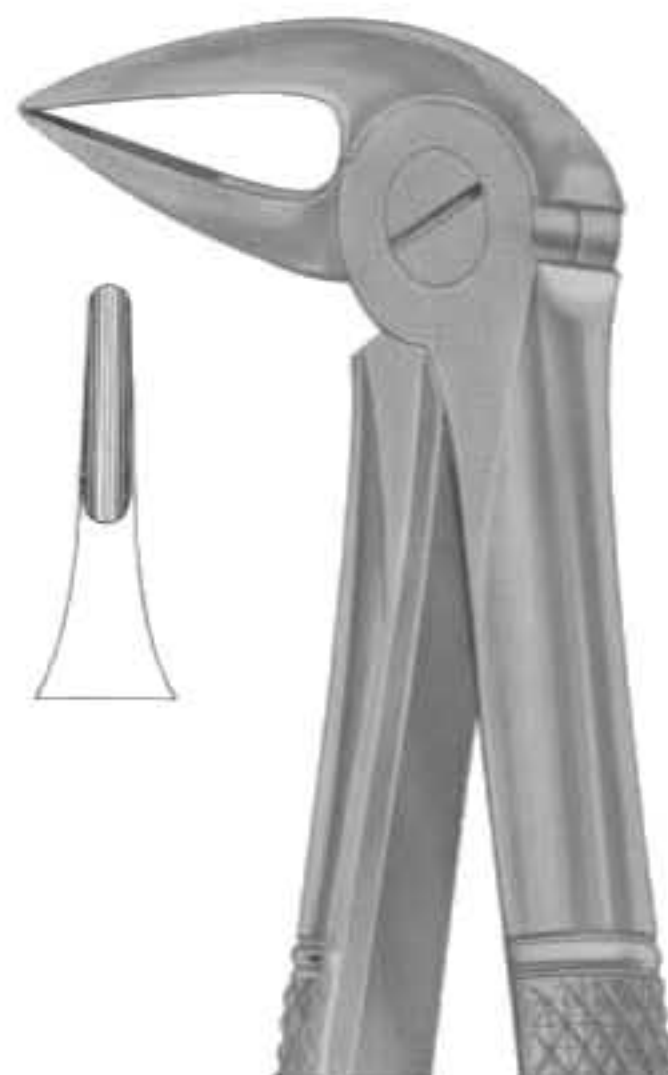

**1032**  
Fig. 33L  
lower roots



**1033**  
Fig. 37  
upper incisors  
for children



**1035**  
Fig. 38  
lower incisors &  
canines for children



**1036**  
Fig. 39  
upper molars  
for children



**1037**  
Fig. 39R  
upper molars right  
for children



**1040**  
Fig. 39L  
upper molars left  
for children



**1038**  
Fig. 39A  
upper molars  
for children



**1039**  
Fig. 40  
lower molars  
for children

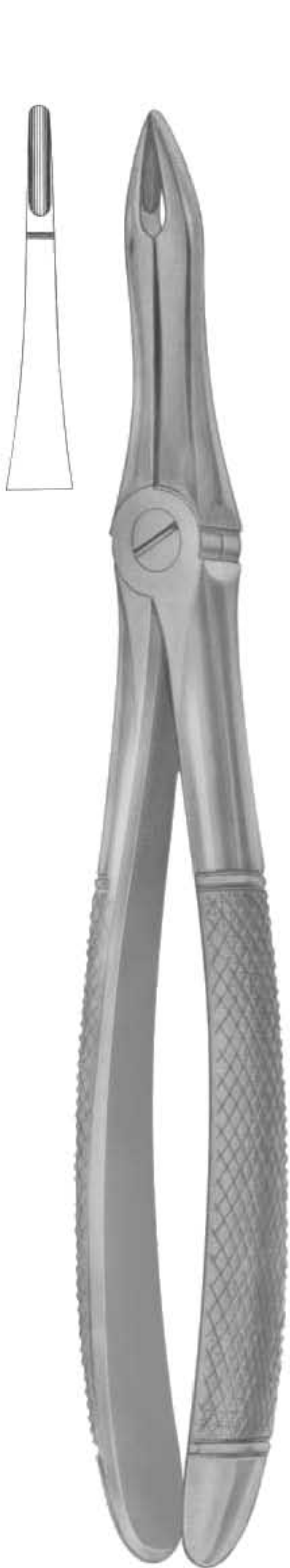

**1041**  
Fig. 41  
upper roots

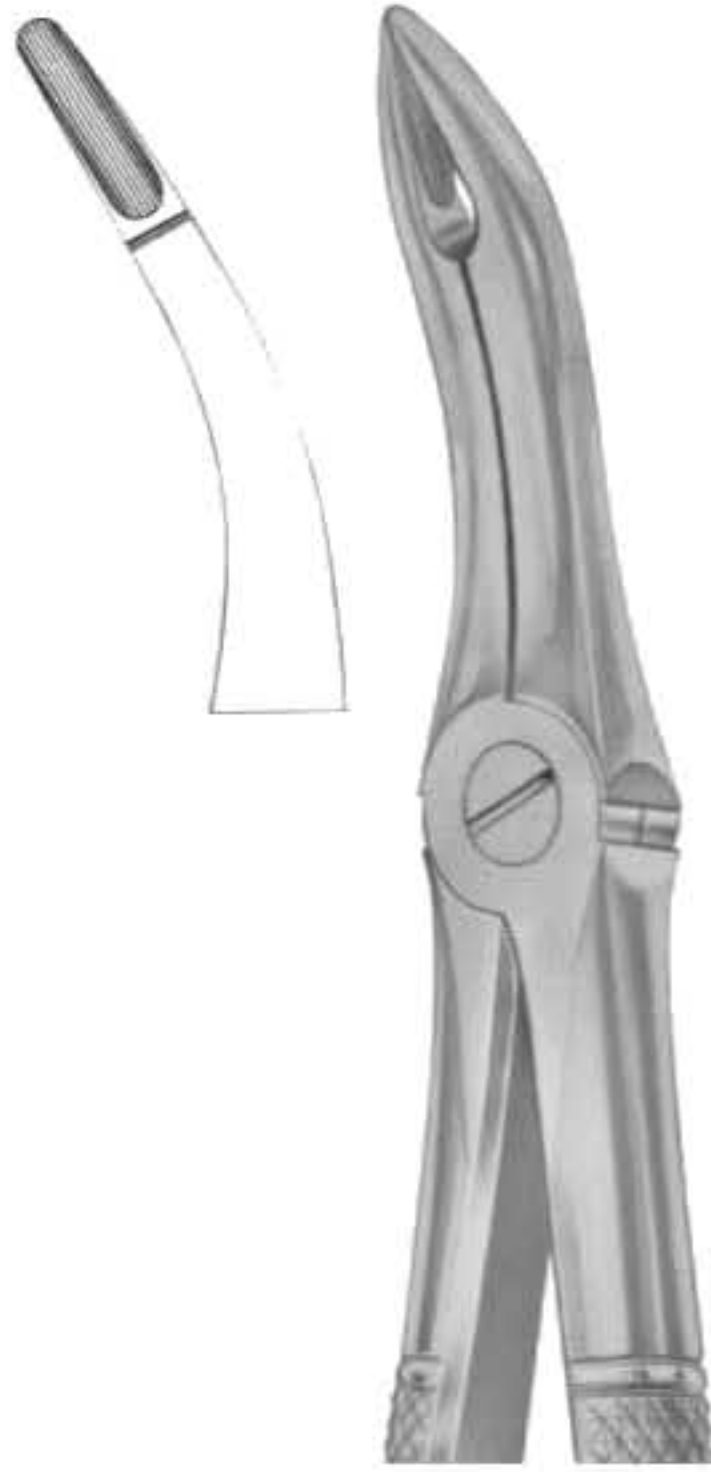

**1042**  
Fig. 44  
upper roots

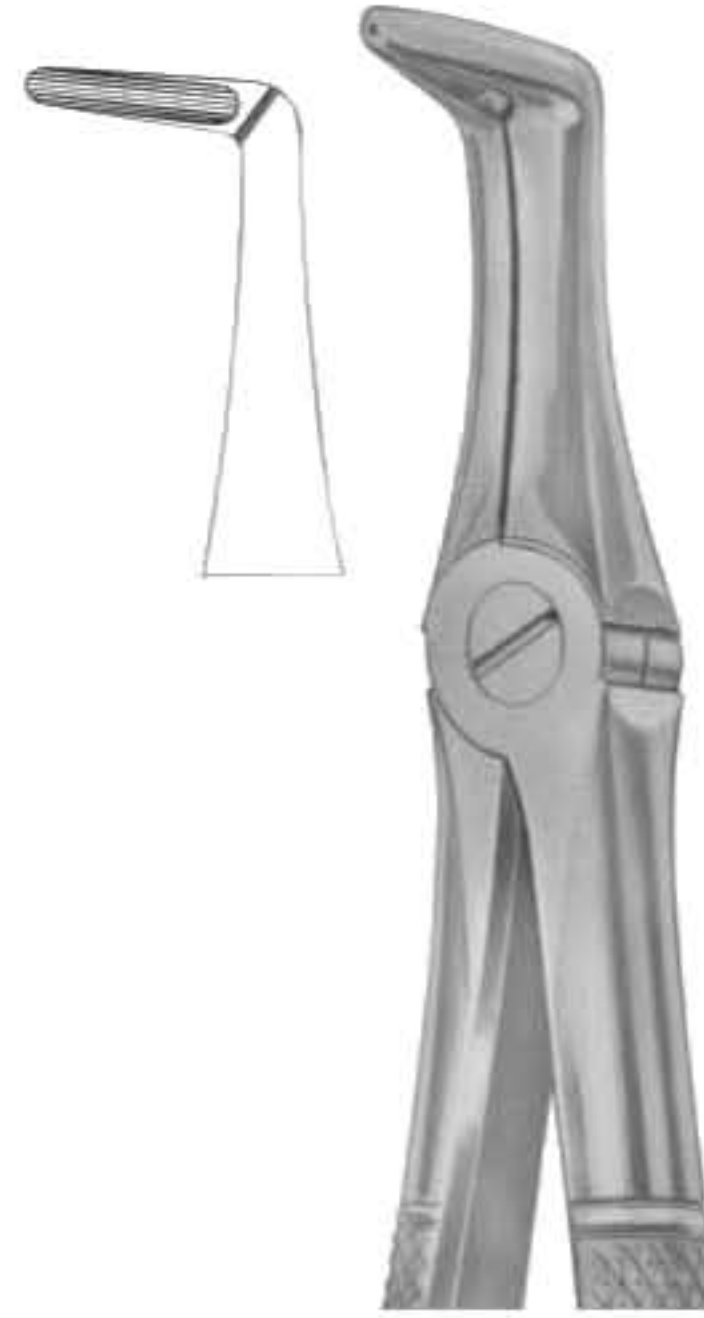

**1043**  
Fig. 45  
lower roots

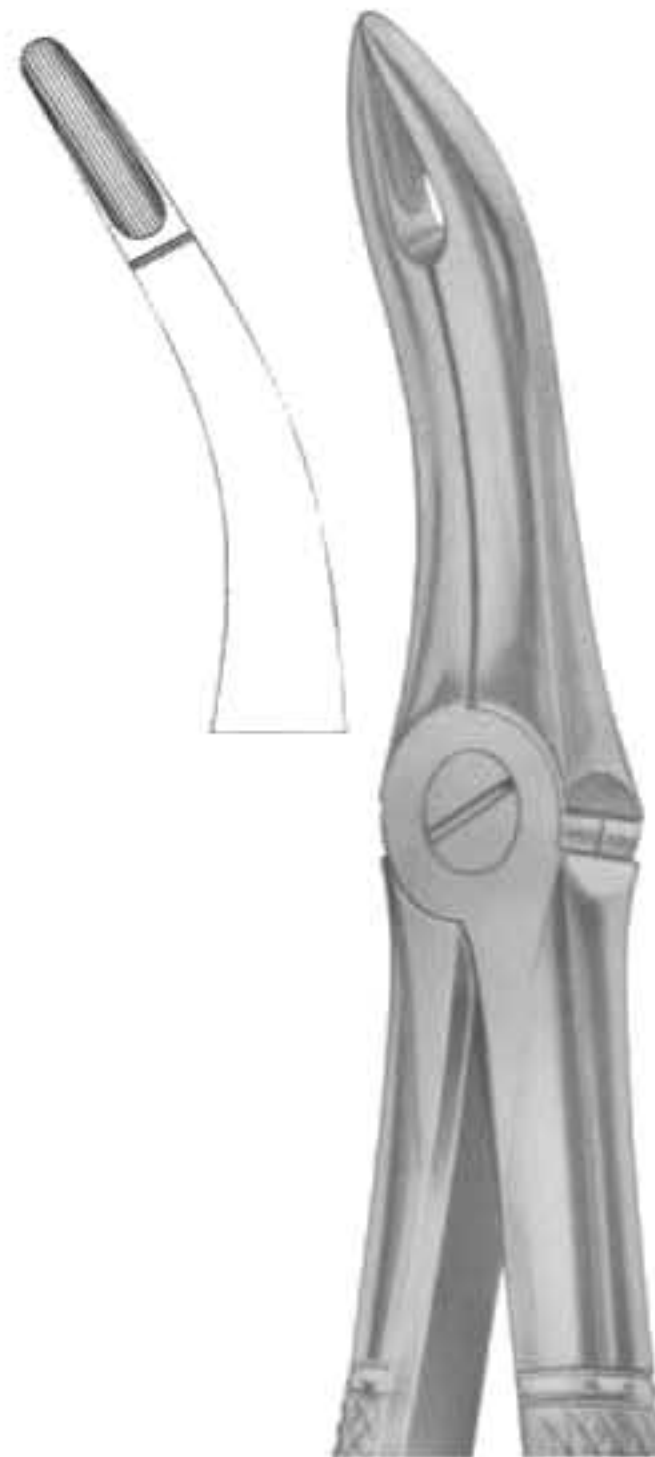

**1044**  
Fig. 48  
lower roots

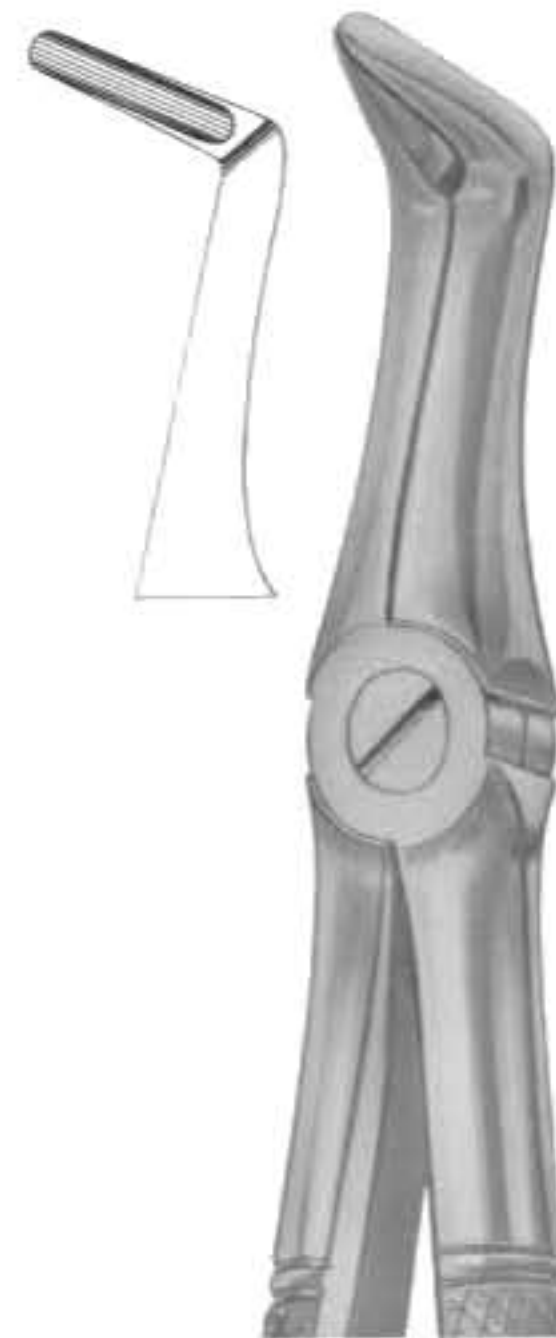

**1045**  
Fig. 49  
upper roots

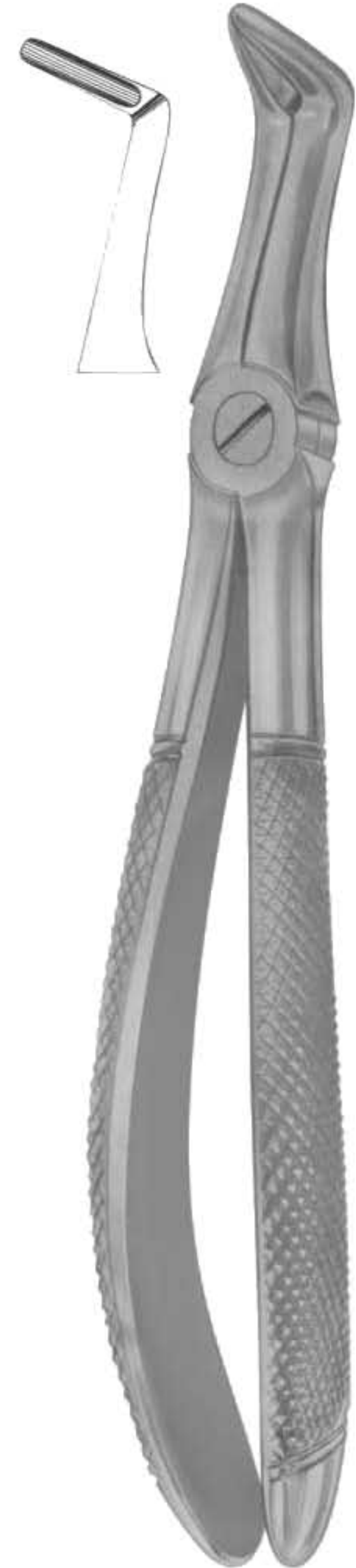

**1046**  
Fig. 50  
upper roots



**1047**  
Fig. 51  
upper roots

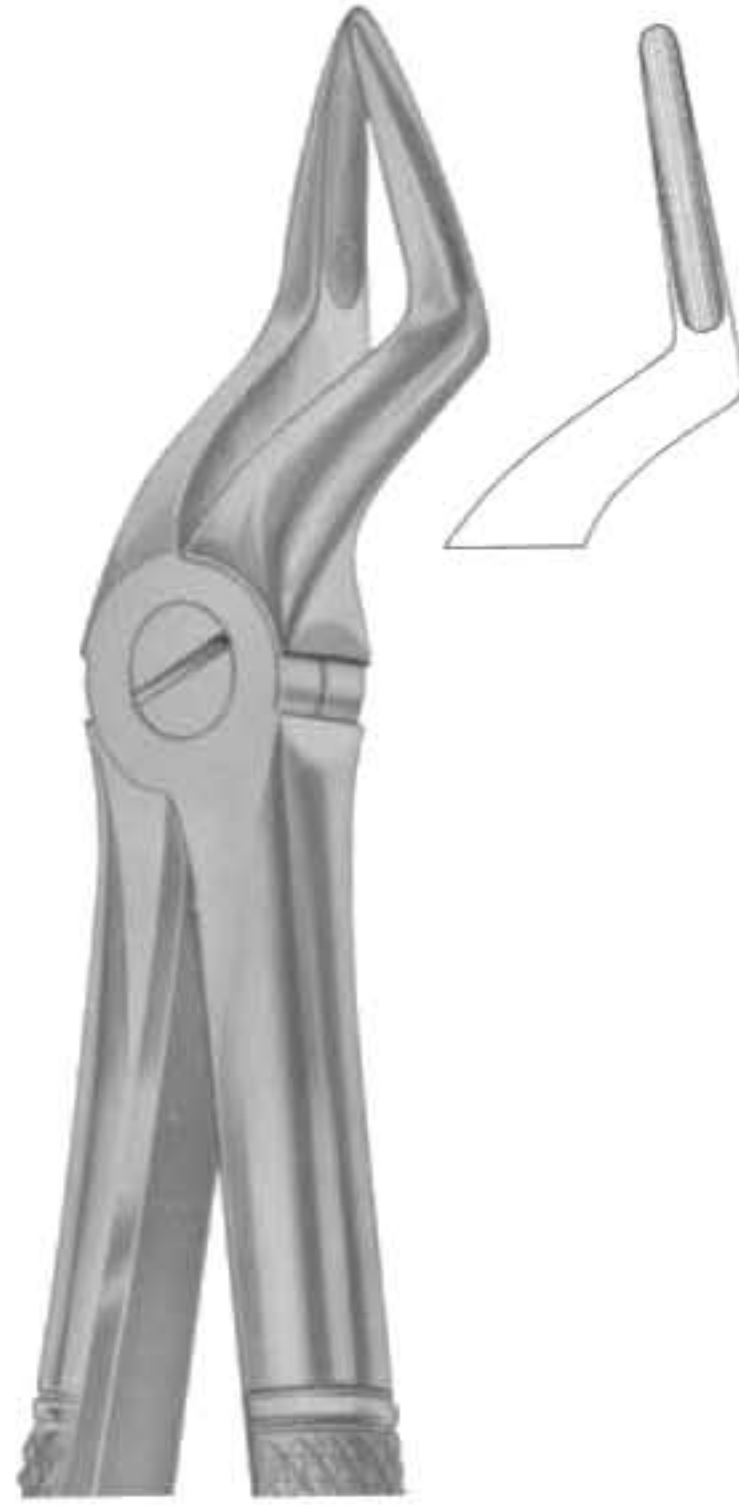

**1048**  
Fig. 51A  
upper roots

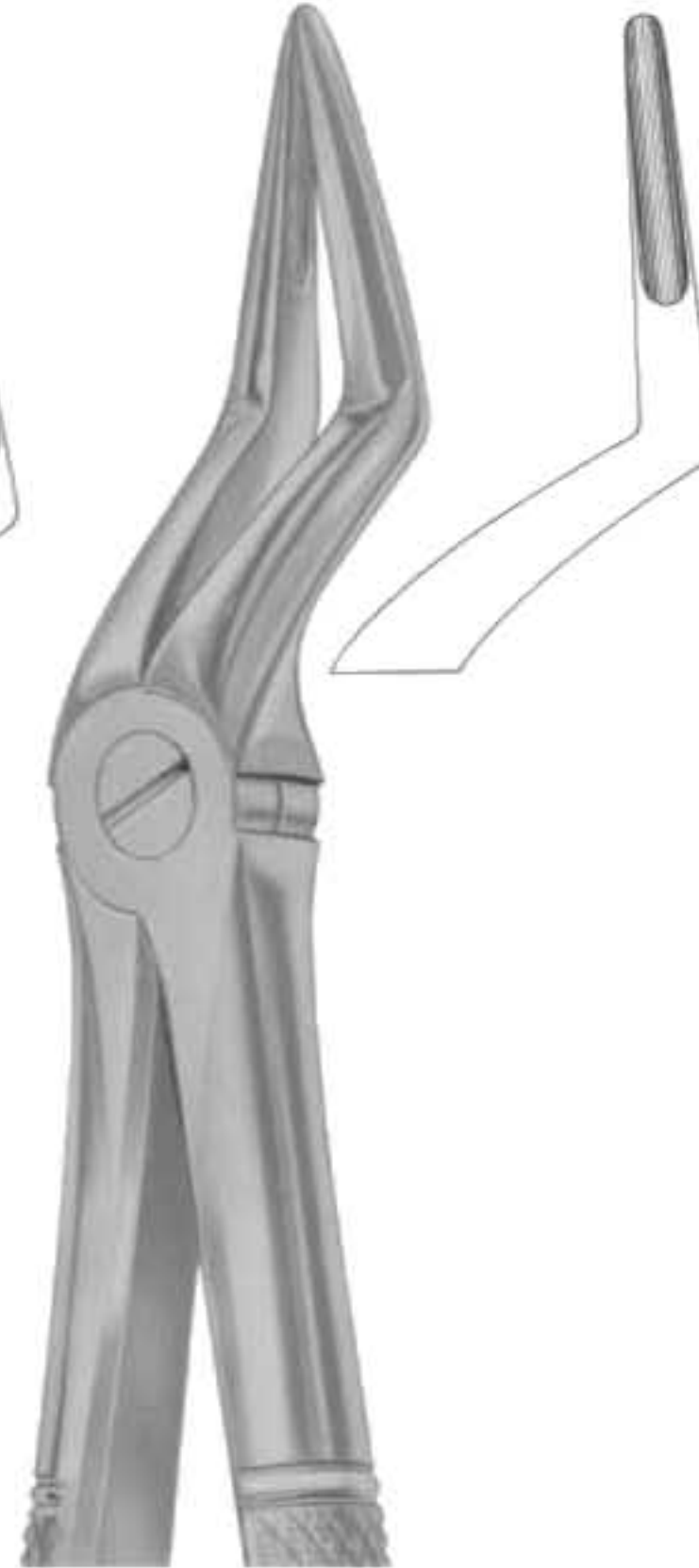

**1049**  
Fig. 51L  
upper roots

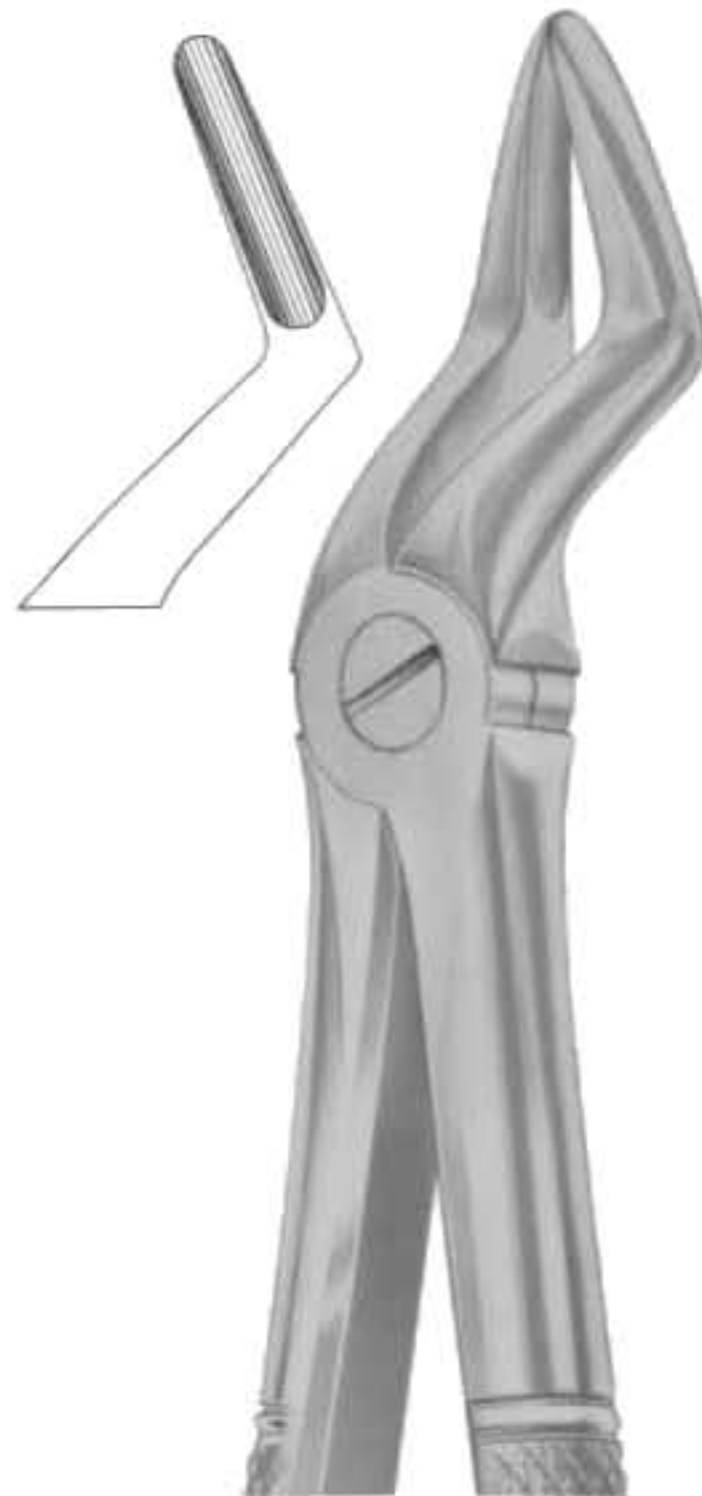

**1050**  
Fig. 52  
upper roots

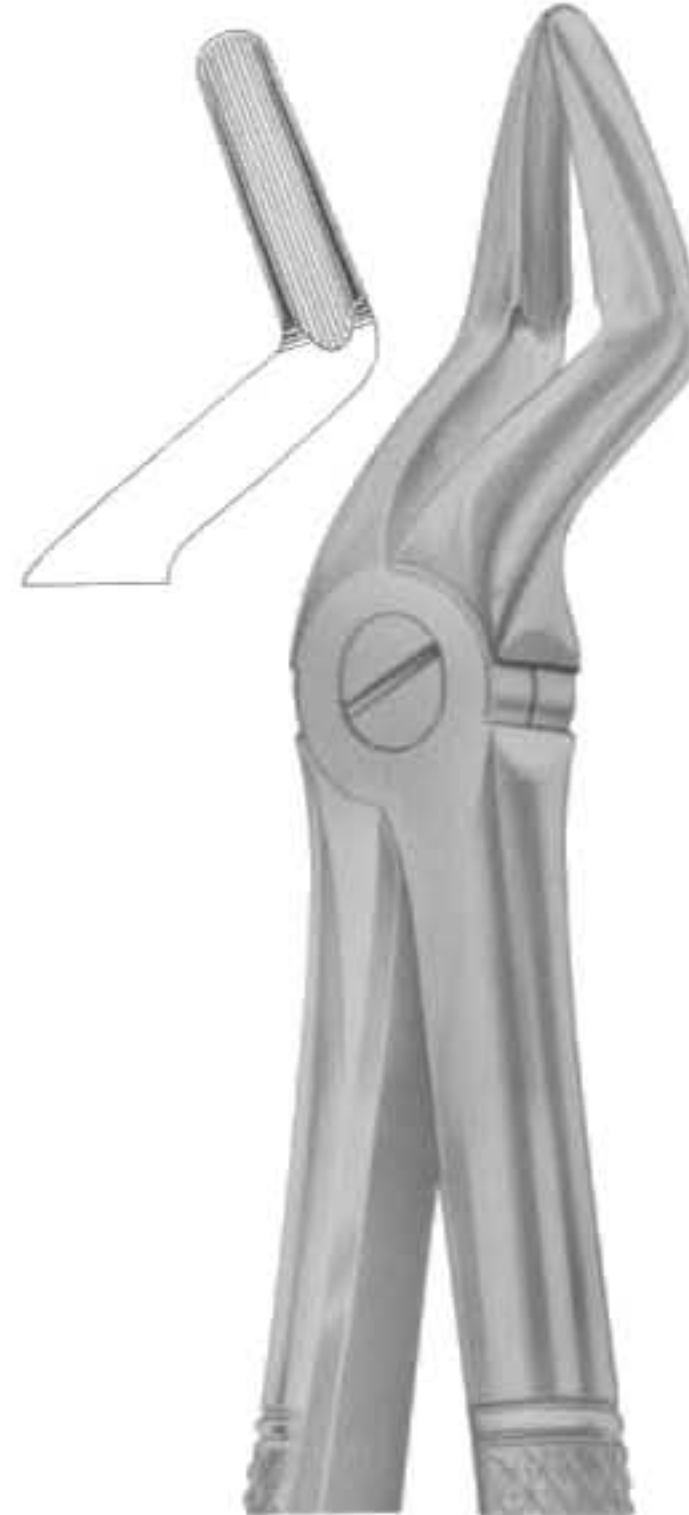

**1051**  
Fig. 52A  
upper teeth  
and resection

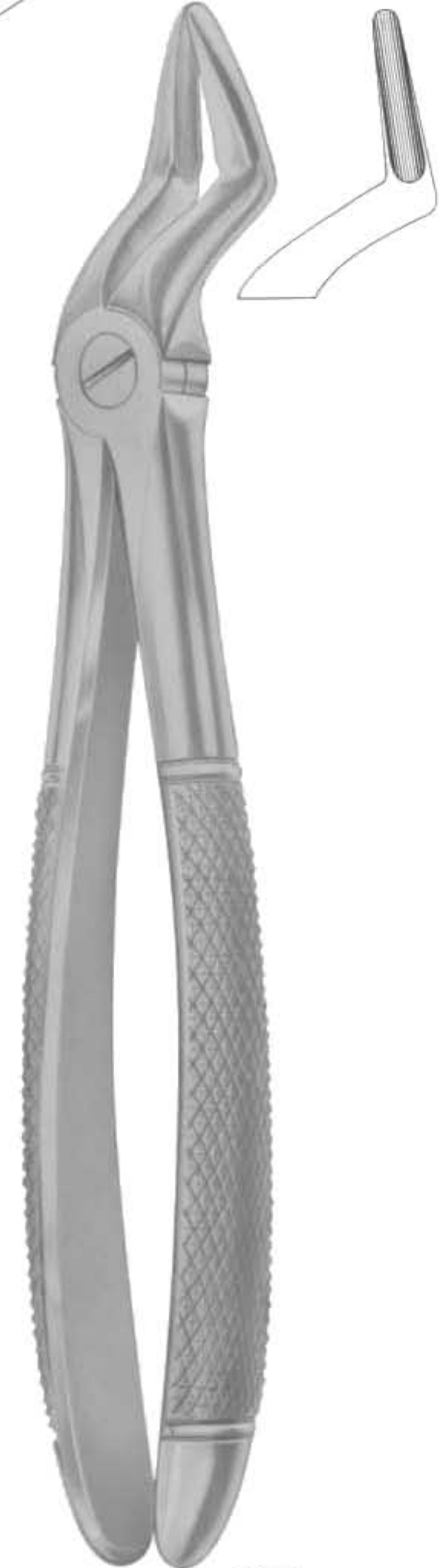

**1052**  
Fig. 51S  
upper roots  
for children



**1053**  
Fig. 54  
for separating  
upper molars



**1054**  
Fig. 55  
for separating  
upper molars



**1055**  
Fig. 56  
for separating  
lower molars

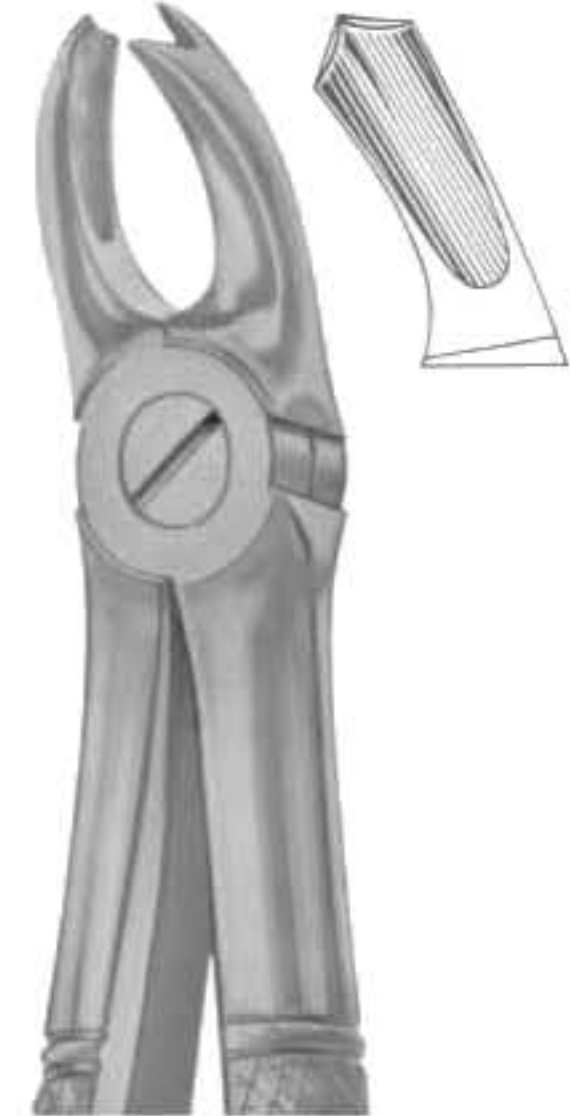

**1056**  
Fig. 65R  
upper molars  
right

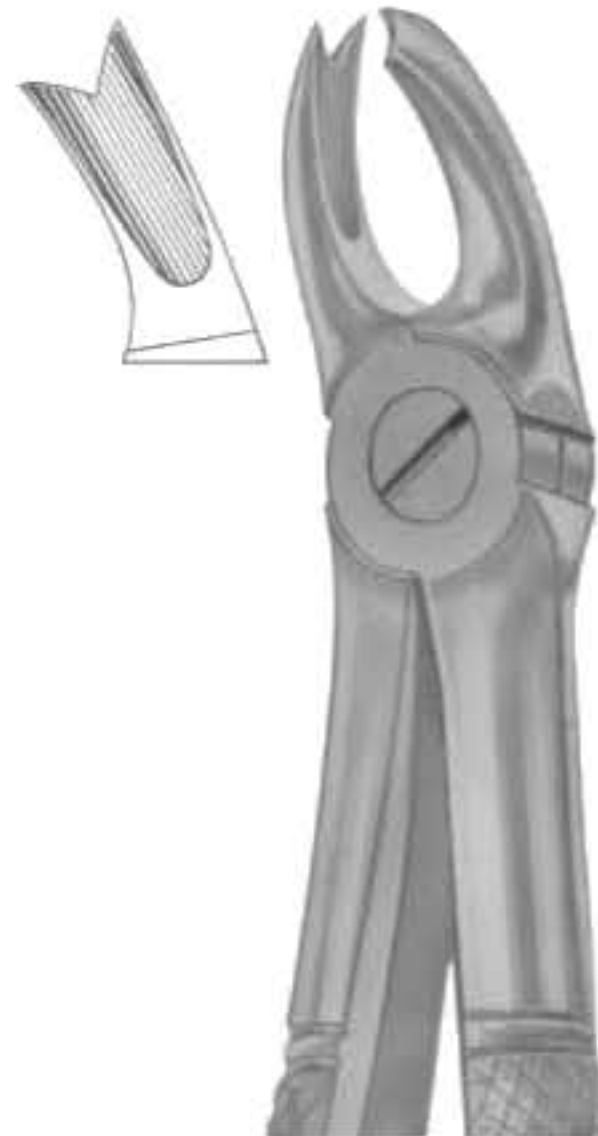

**1057**  
Fig. 65L  
upper molars left



**1058**  
Fig. 67  
upper third molars

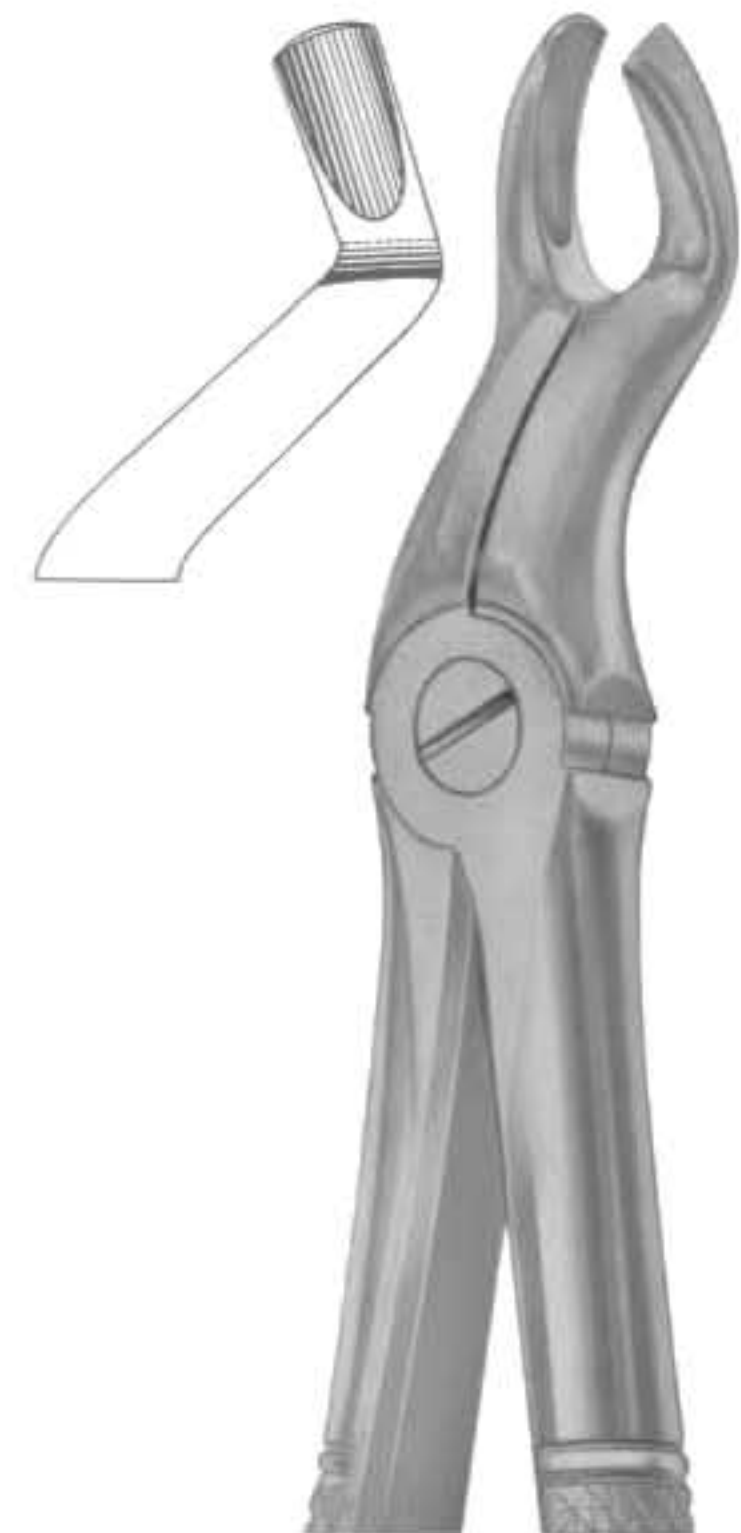

**1059**  
Fig. 67A  
upper third molars

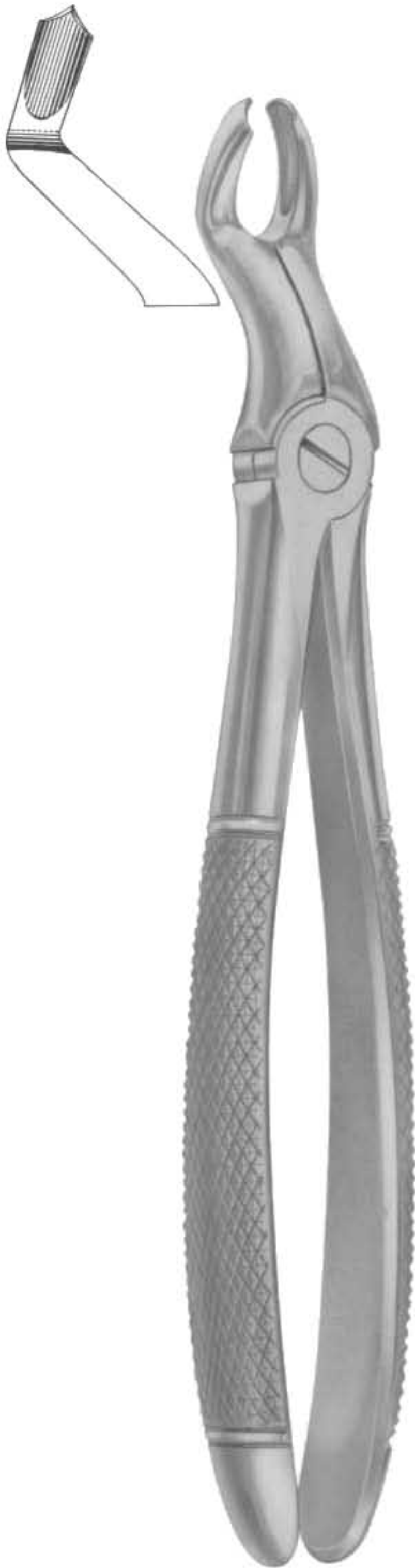

**1060**  
Fig. 67 1/2R  
upper third molars  
right



**1061**  
Fig. 67 1/2L  
upper third molars  
left

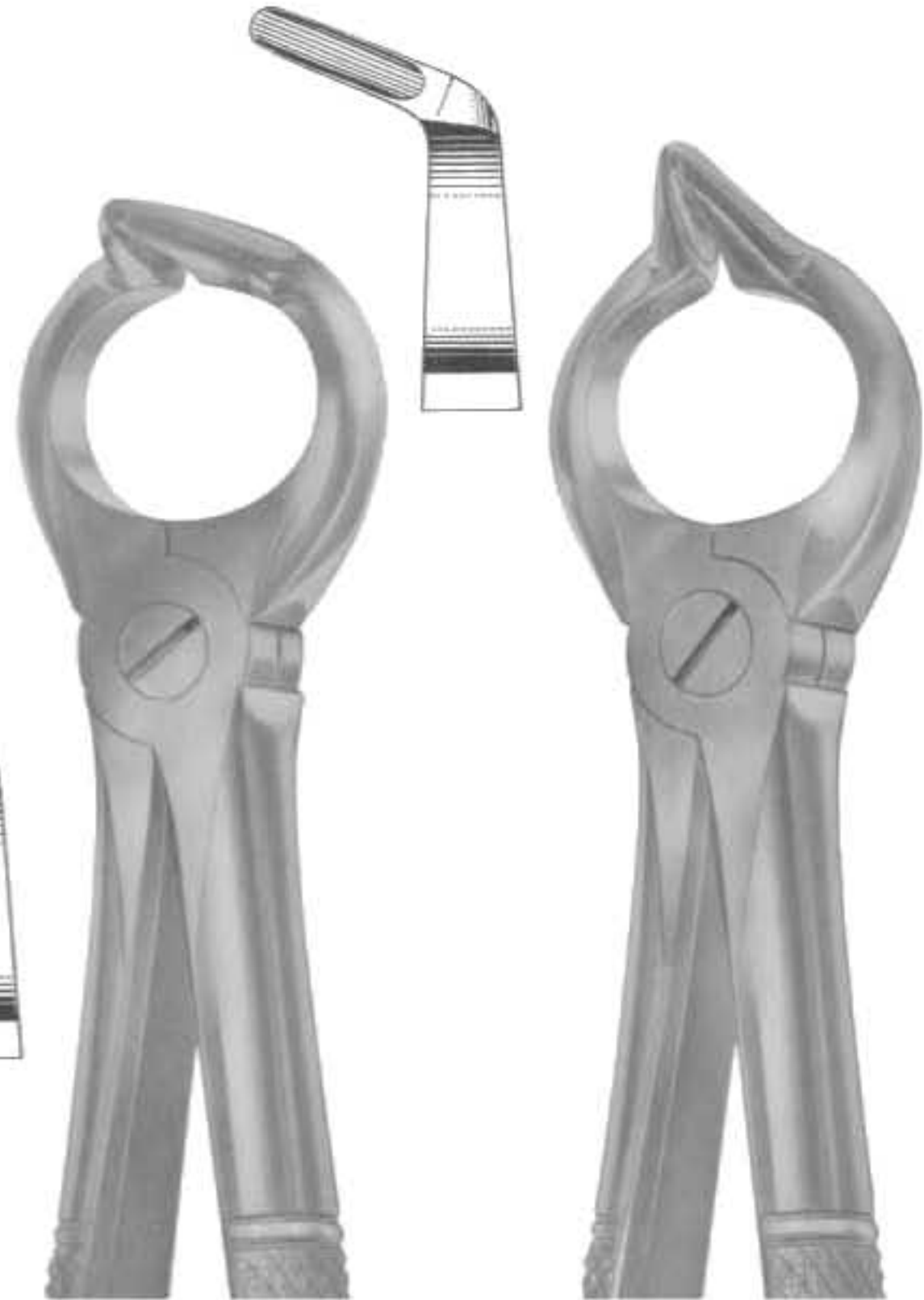

**1062**  
Fig. 68  
lower roots



**1063**  
Fig. 68A  
lower roots



**1064**  
Fig. 73  
lower molars

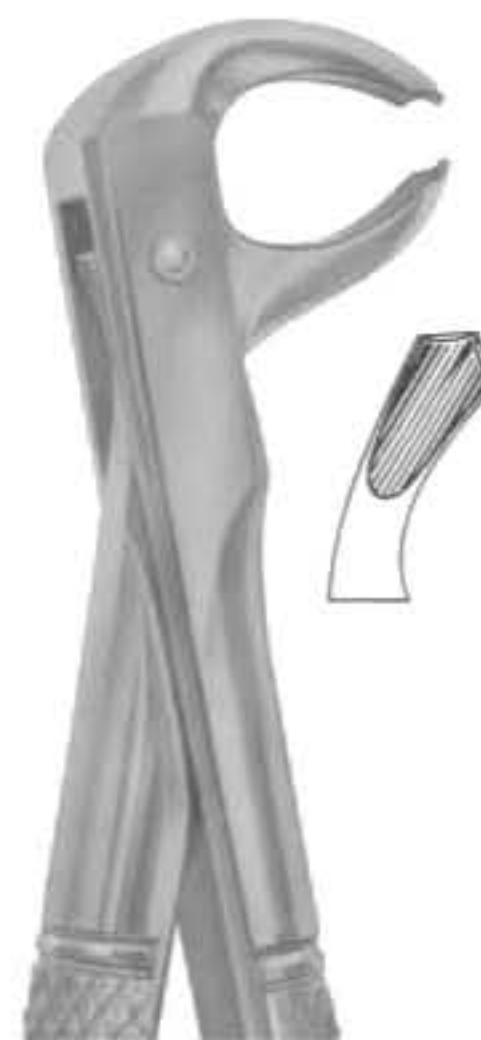

**1065**  
Fig. 73R  
lower molars right

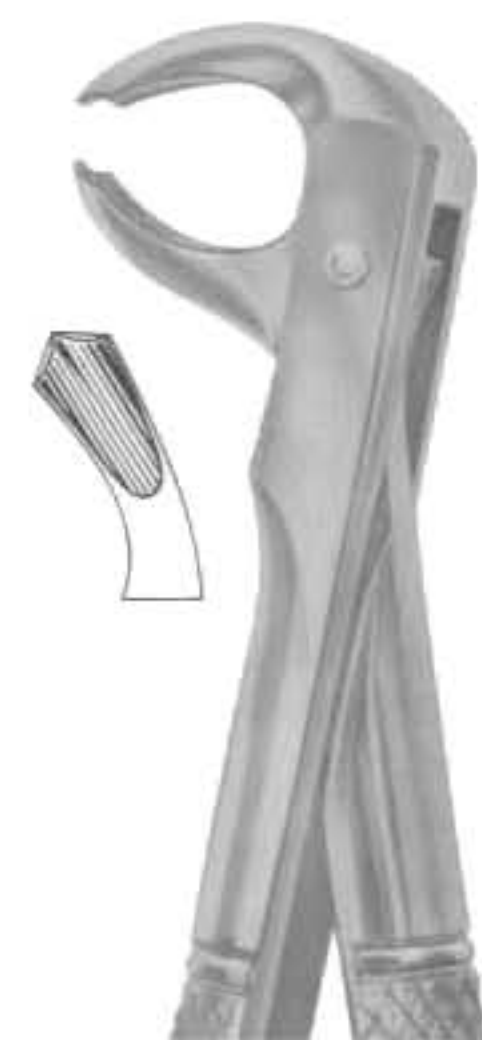

**1066**  
Fig. 73L  
lower molars left





**1067**  
Fig. 73A  
lower molars



**1068**  
Fig. 73S  
lower molars



**1069**  
Fig. 73B  
lower molars for children



**1072**  
Fig. 73K  
lower molars  
for children

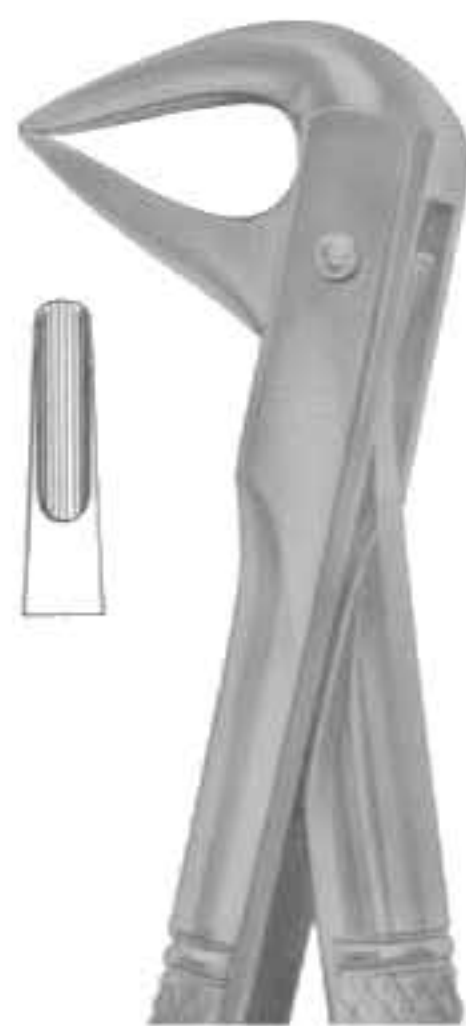

**1070**  
Fig. 74  
lower roots



**1071**  
Fig. 74D  
lower roots

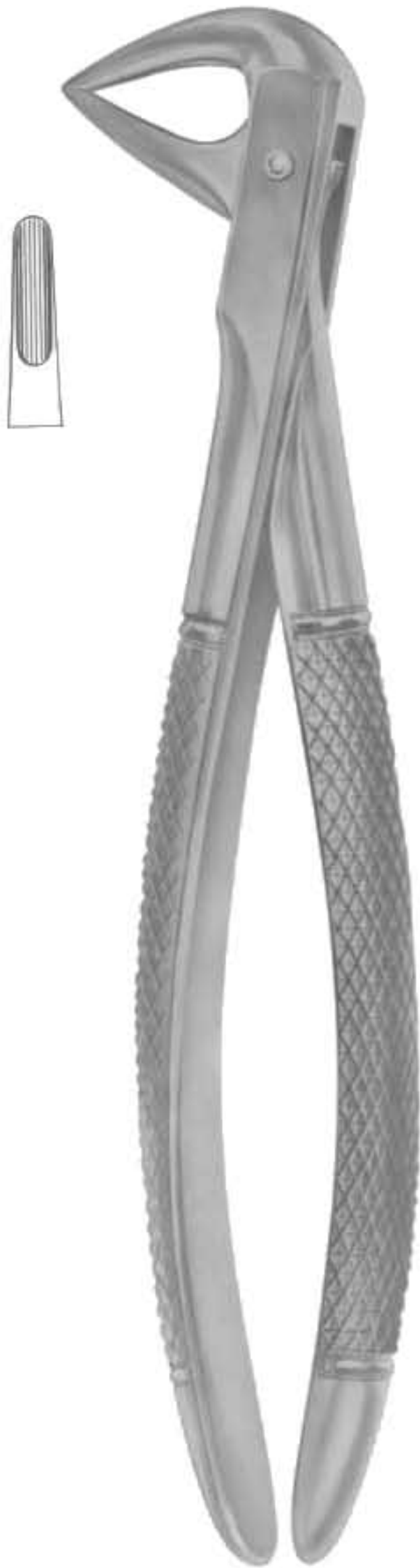

**1073**  
Fig. 74M  
lower roots

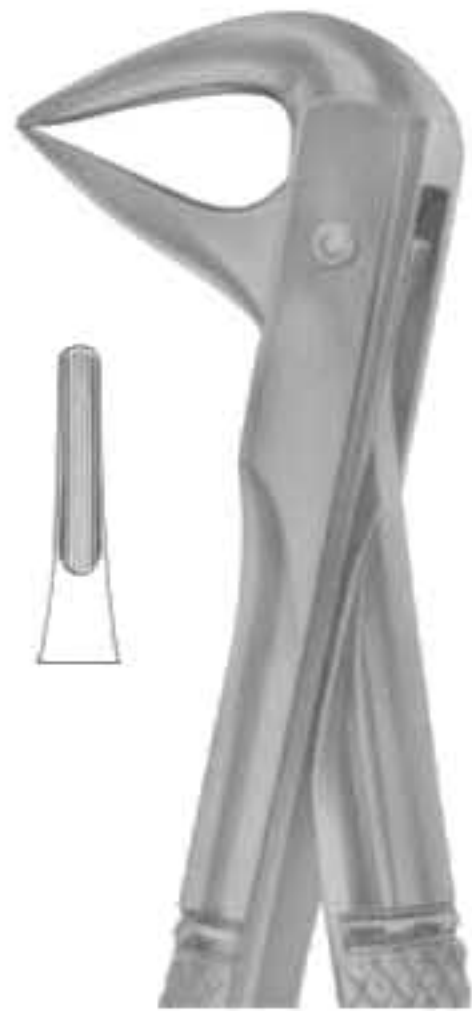

**1074**  
Fig. 74N  
lower roots

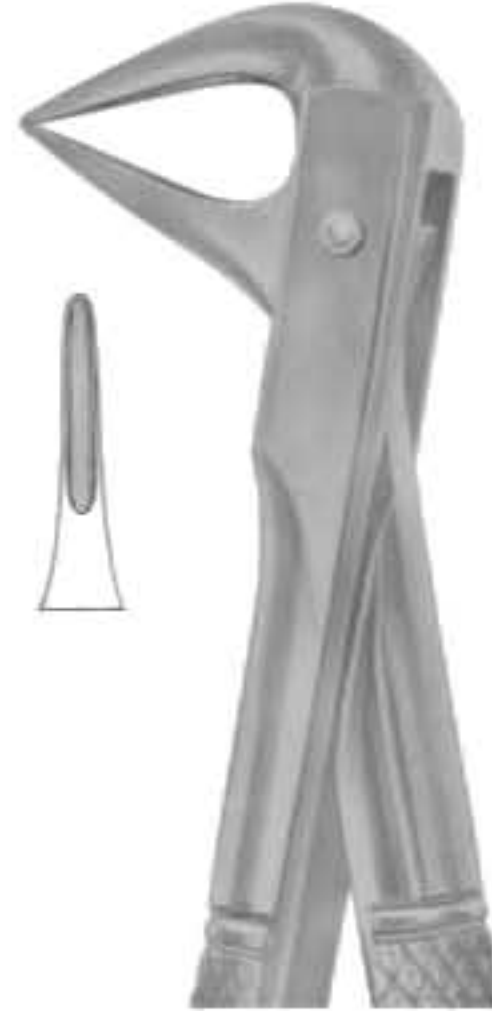

**1075**  
Fig. 74XN  
lower roots and  
crowded incisors



**1078**  
Fig. 76N  
upper roots

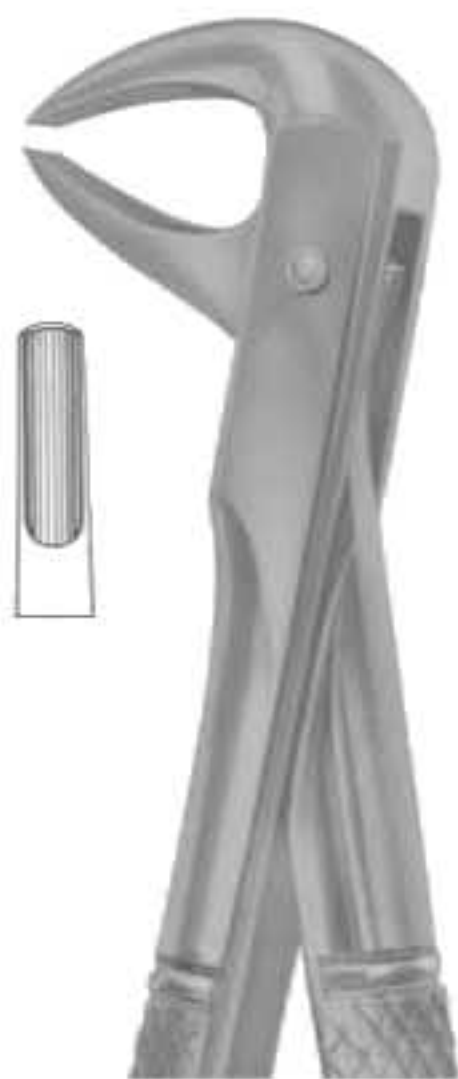

**1076**  
Fig. 75  
lower premolars



**1077**  
Fig. 76  
upper roots



**1079**  
Fig. 76S  
upper roots



**1080**  
Fig. 79  
lower third molars



**1081**  
Fig. 79A  
lower third molars

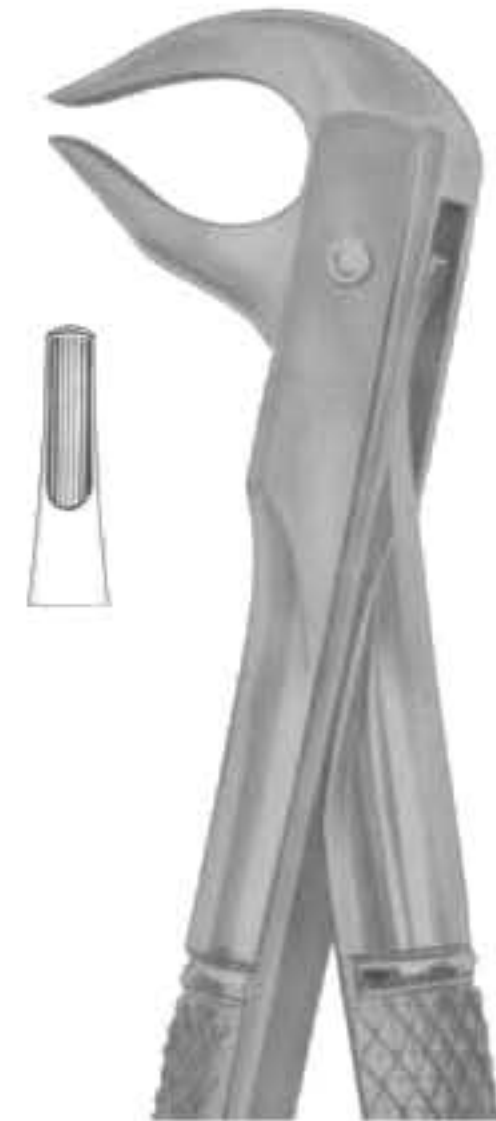

**1082**  
Fig. 81  
lower premolars  
and roots



**1083**  
Fig. 86A  
lower molars



**1084**  
Fig. 86B  
lower molars



**1085**  
Fig. 86C  
lower molars

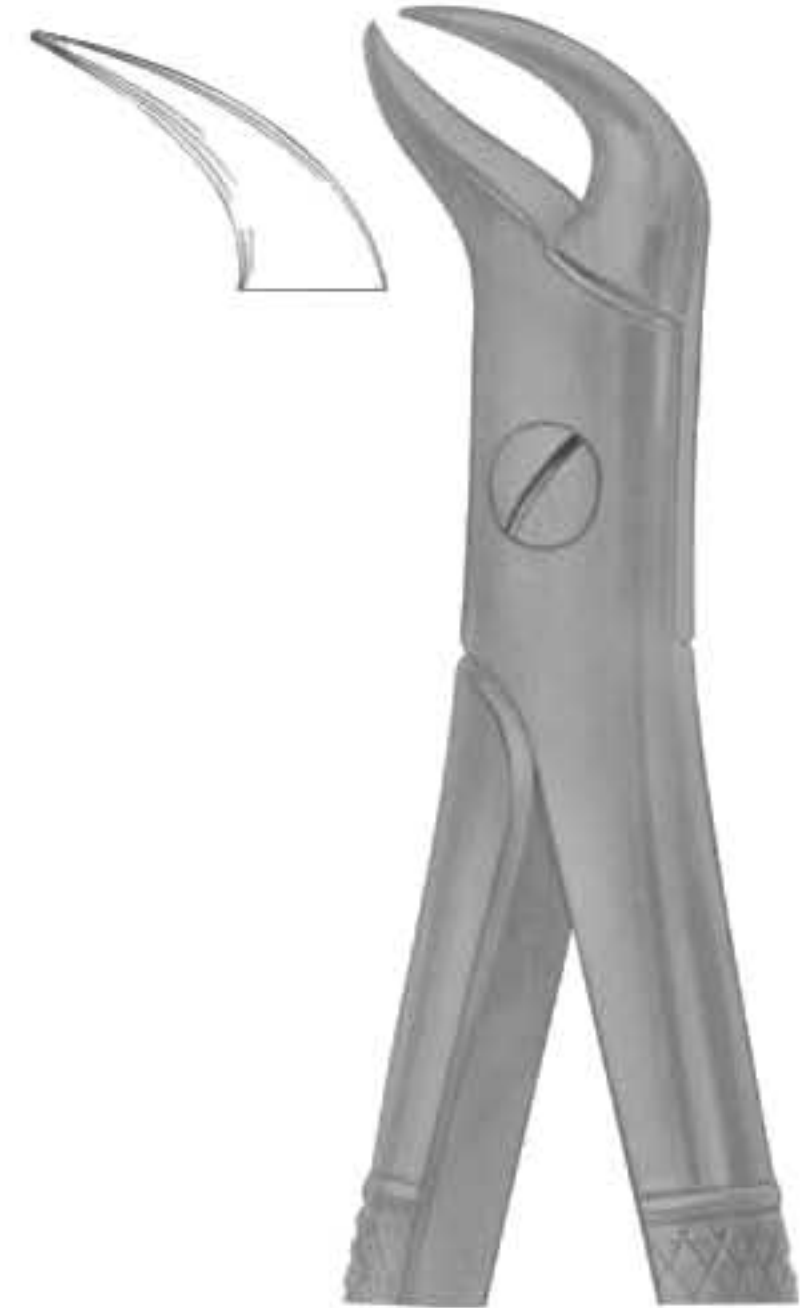

**1086**  
Fig. 87  
lower molars



**1087**  
Fig. 91  
for separating  
lower molars

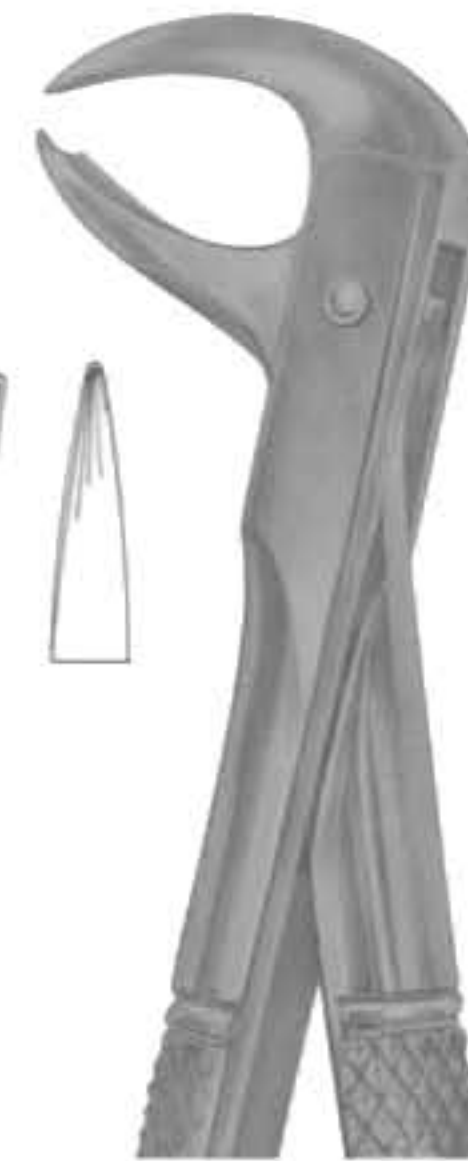

**1088**  
Fig. 99  
lower molars



**1089**  
Fig. 101  
upper premolars  
and roots

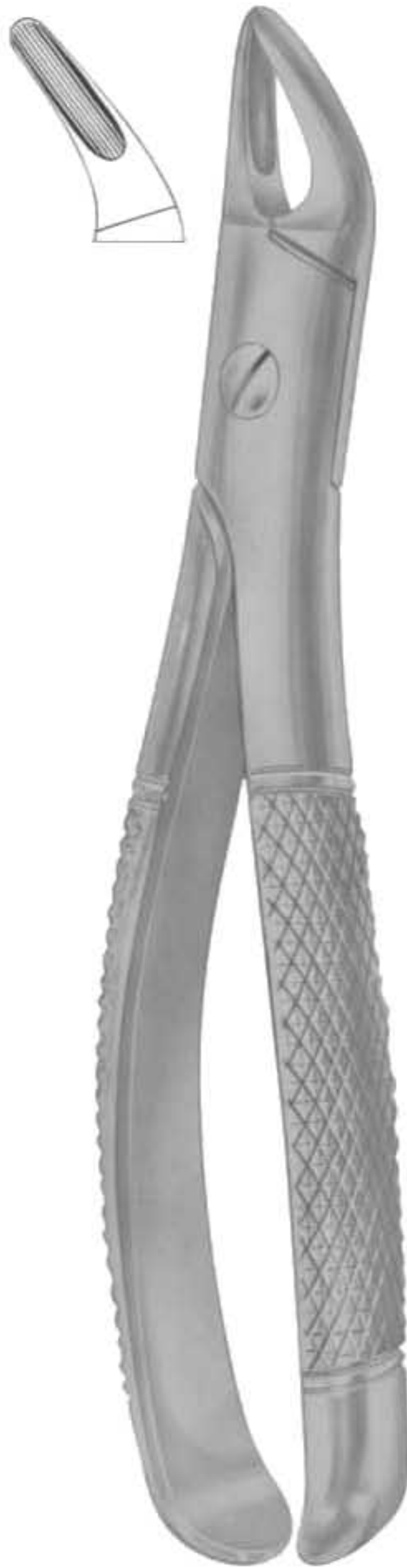

**1090**  
Fig. 100  
upper roots



**1091**  
Fig. 99 1/4  
lower molars



**1092**  
Fig. 99 1/2  
lower molars



**1093**  
Fig. 102  
upper molars right



**1094**  
Fig. 103  
upper molars left



**1095**  
Fig. 105  
lower incisors



**1096**  
Fig. 106  
lower incisors



**1097**  
Fig. 103  
upper canines



**1098**  
Fig. 112  
upper roots



**1099**  
Fig. 113  
upper roots



**1101**  
Fig. 136  
upper premolars  
and roots

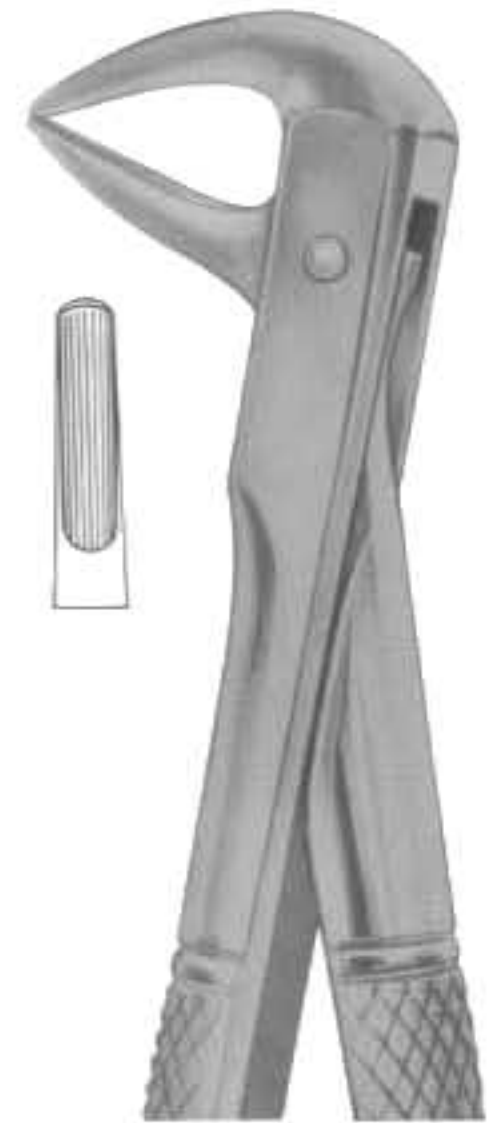

**1102**  
Fig. 137  
lower incisors  
and roots



**1100**  
Fig. 114  
upper roots



**1103**  
Fig. 143  
lower roots



**1104**  
MEAD (MD 1)  
upper anteriors,  
roots, incisors, canines

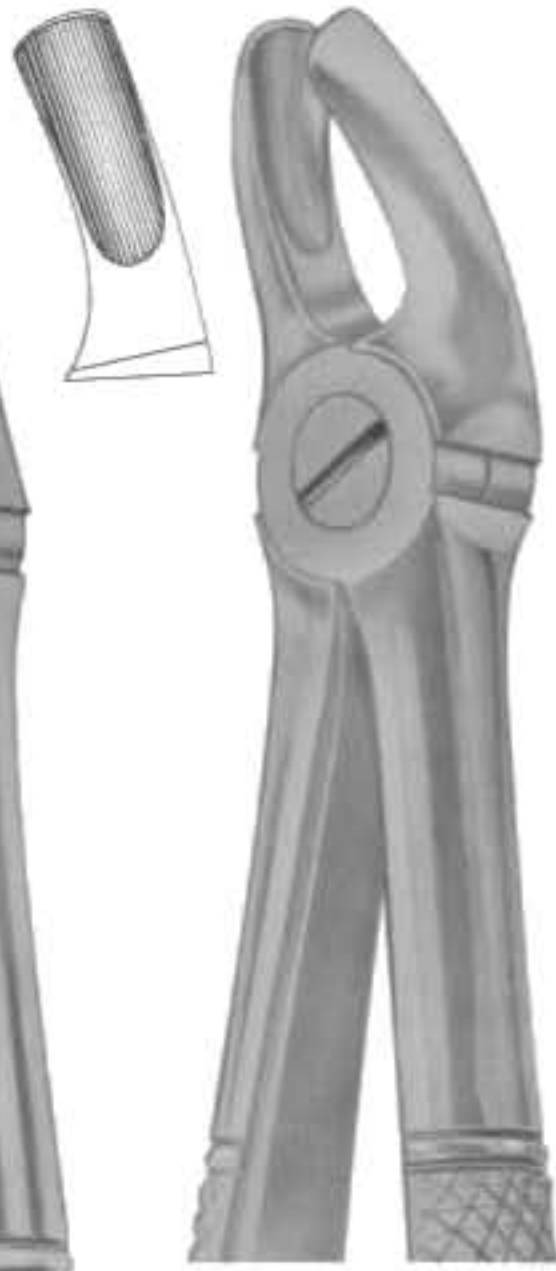

**1105**  
MEAD (MD 2)  
upper molars

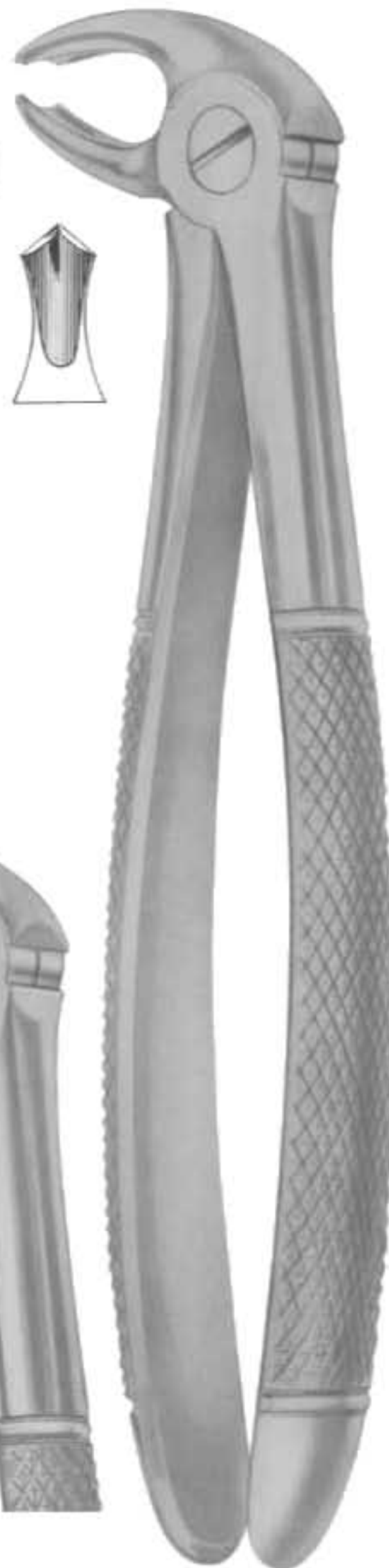

**1106**  
MEAD (MD 3)  
lower roots

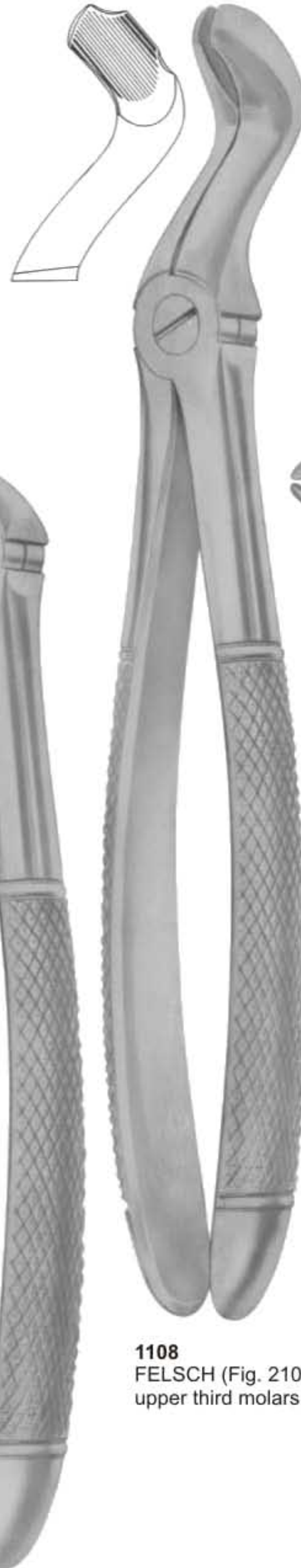

**1107**  
MEAD (MD 4)  
lower molars



**1108**  
FELSCH (Fig. 210)  
upper third molars

**1109**  
HERTZ (Fig. 211)  
lower incisors





**1110**  
ROUTURIER (Fig. 212)  
( 22 ½ L )  
lower molars  
and wisdom left



**1111**  
ROUTURIER (Fig. 213)  
( 22 ½ R )  
lower molars  
and wisdom right



**1112**  
ROUTURIER (Fig. 214)  
( 22 ½ L )  
lower molars  
and wisdom left



**1113**  
ROUTURIER (Fig. 215)  
( 33 ½ R )  
lower molars  
and wisdom right

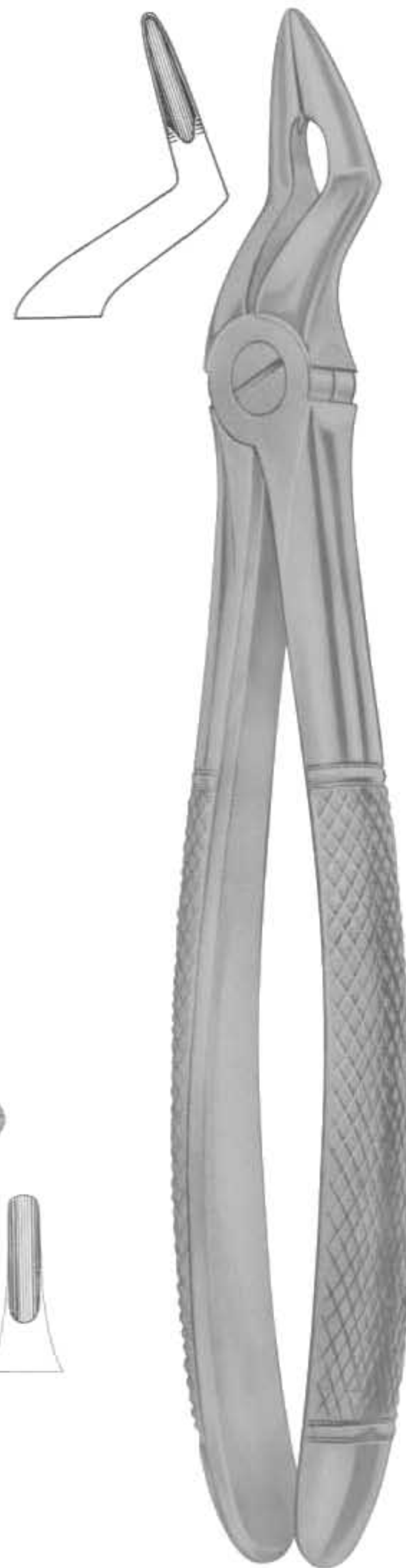

**1114**  
RESECTION FORCEPS  
( 216/Witzel )  
upper roots



1115  
Fig. 5



1116  
Fig. 6



1117  
Fig. 9



1118  
Fig. 10



1119  
Fig. 11



1120  
Fig. 12



1121  
Fig. 14



1122  
Fig. 15



1123  
Fig. 25



1124  
Fig. 26



1125  
Fig. 27



1126  
Fig. 28



1127  
Fig. 34



1128  
Fig. 35



1129  
Fig. 42



1130  
Fig. 43



1131  
Fig. 44A



1132  
Fig. 46



1133  
Fig. 47



1134  
Fig. 50A



1135  
Fig. 74R



1136  
Fig. 74L



1137  
Fig. 75R



1138  
Fig. 75L



1139  
Fig. 94



1140  
Fig. 95



1141  
Fig. 98



1142  
Fig. 105

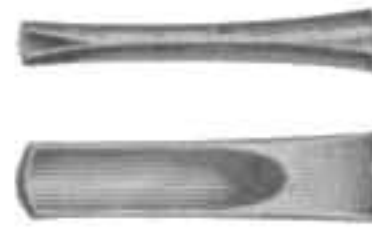

1143  
Fig. 106



1144  
Fig. 2002



**1145**  
Fig. 1  
upper laterals  
and canines



**1146**  
Fig. 2  
upper laterals  
and canines

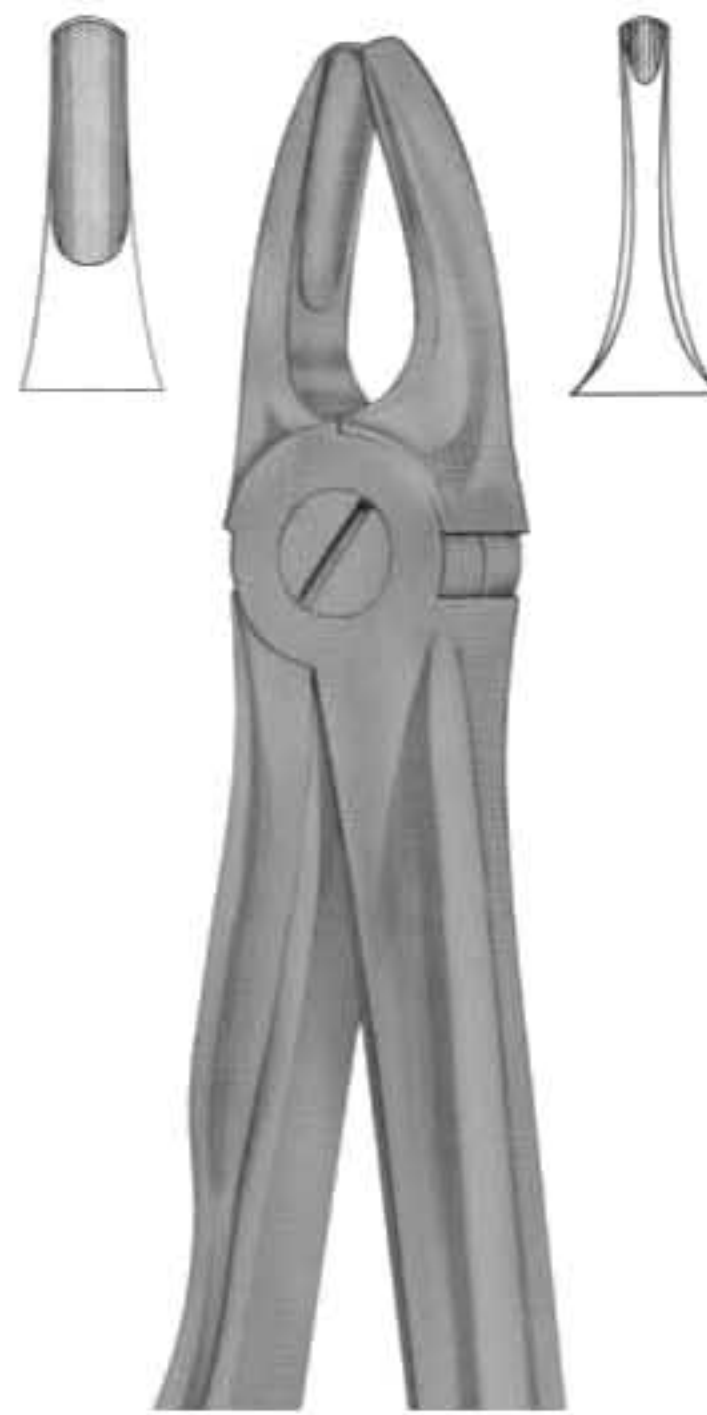

**1147**  
Fig. 3  
upper incisors  
and canines

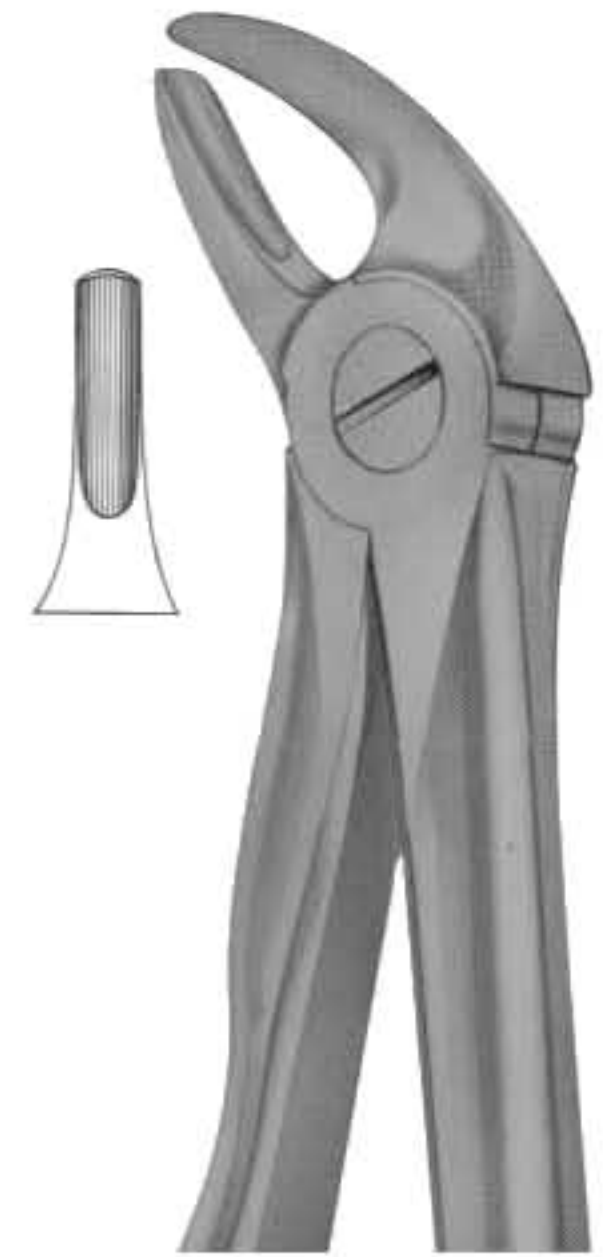

**1148**  
Fig. 4  
lower incisors  
and canines



**1149**  
Fig. 7  
upper premolars

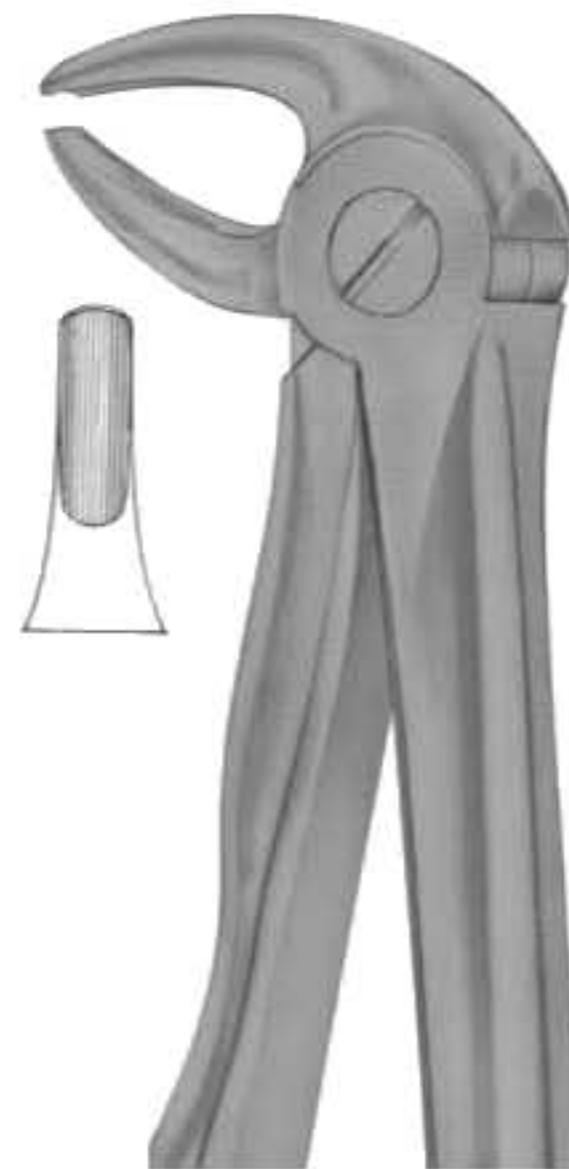

**1150**  
Fig. 13  
lower premolars



**1151**  
Fig. 13S  
lower premolars  
for children



**1152**  
Fig. 17  
upper molars right

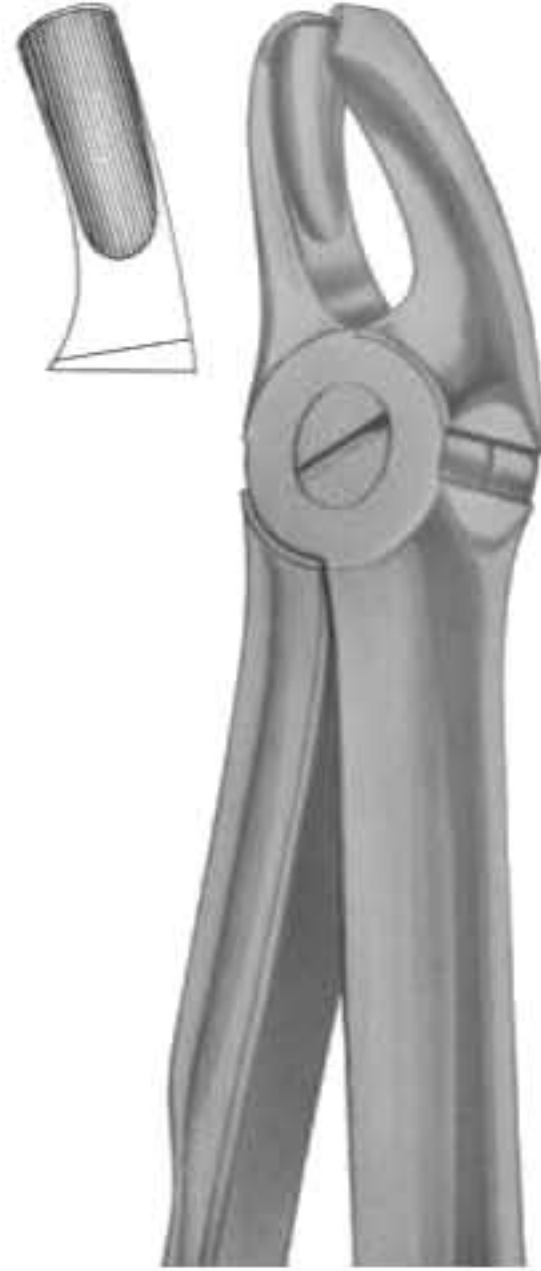

**1153**  
Fig. 18  
upper molars left



**1154**  
Fig. 18A  
upper molars



**1155**  
Fig. 18B  
upper molars



**1156**  
Fig. 19  
upper third molars



**1157**  
Fig. 22  
lower molars



**1158**  
Fig. 22S  
lower molars  
for children



**1159**  
Fig. 29  
upper roots



**1160**  
Fig. 29S  
upper roots  
for children

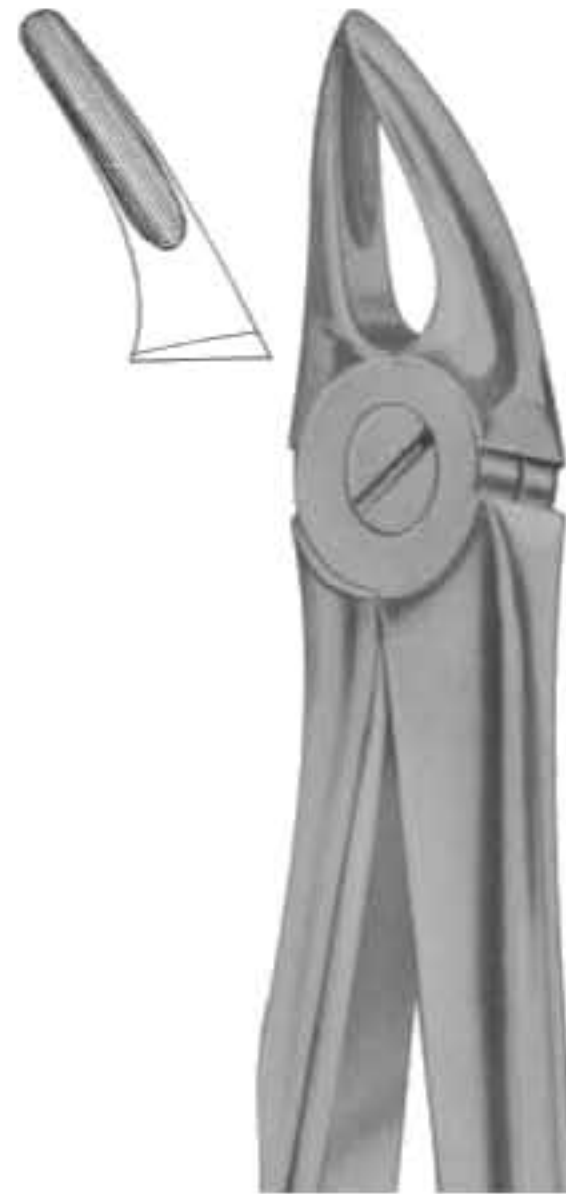

**1161**  
Fig. 30  
upper roots

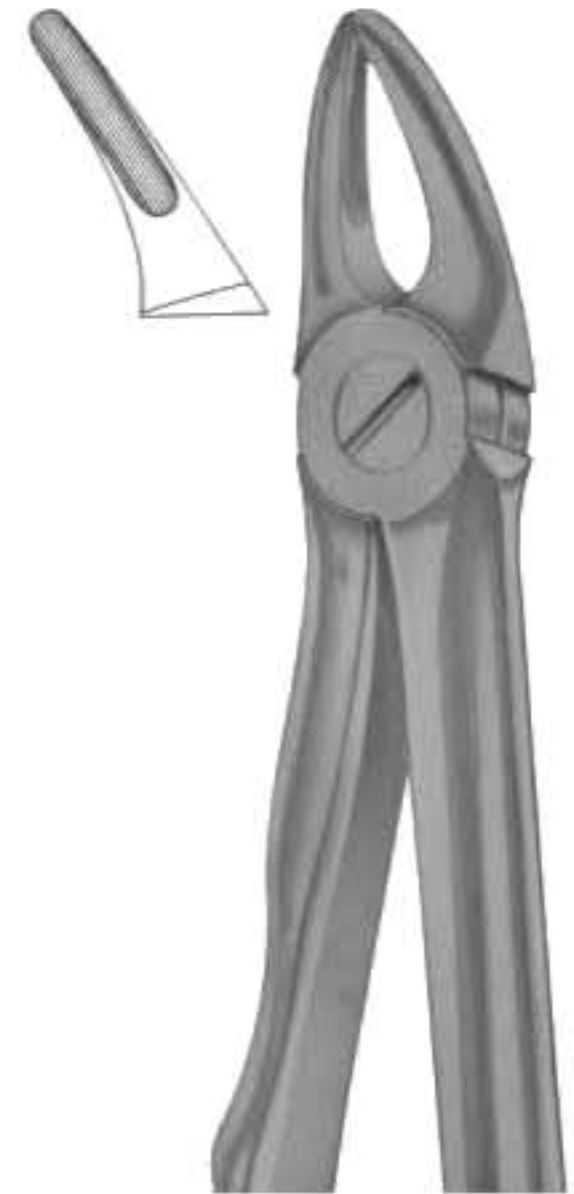

**1162**  
Fig. 30S  
upper roots  
for children

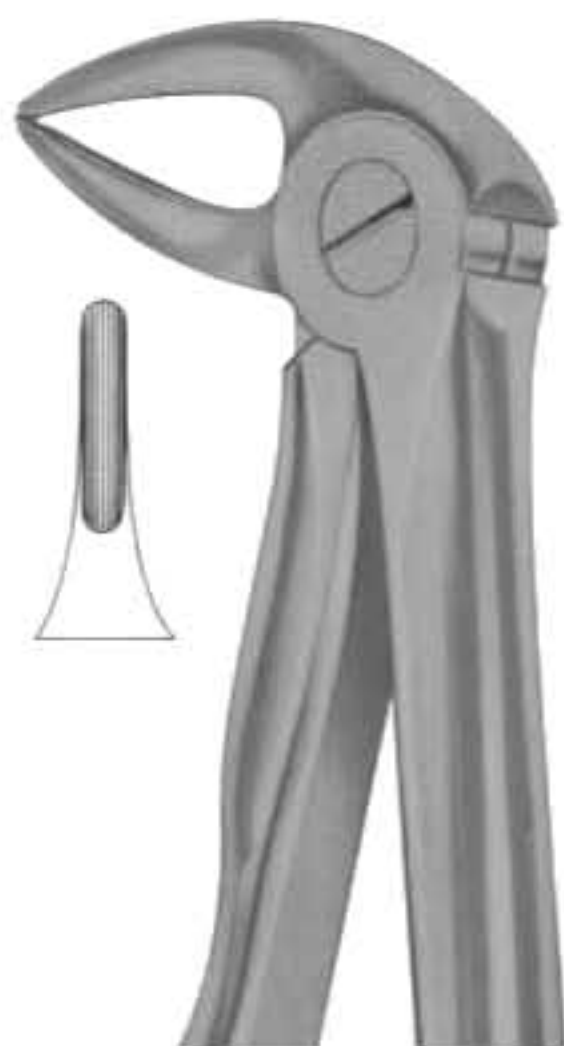

**1163**  
Fig. 33  
lower roots



**1164**  
Fig. 33A  
lower roots

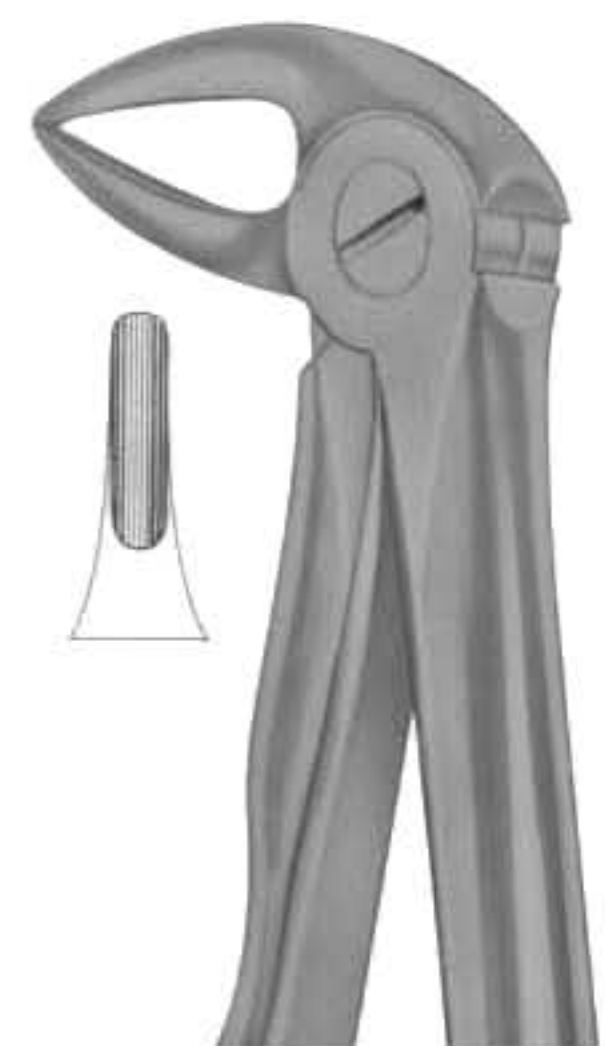

**1165**  
Fig. 33B  
lower roots





**1166**  
Fig. 33L  
lower roots

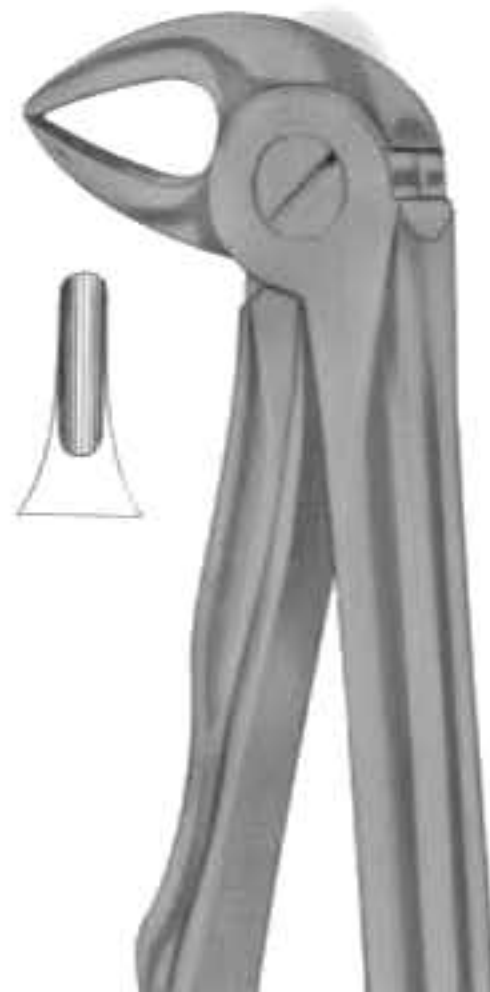

**1167**  
Fig. 33S  
lower roots  
for children



**1168**  
Fig. 37  
upper incisors  
for children



**1169**  
Fig. 39  
upper incisors  
for children



**1170**  
Fig. 39A  
upper molars  
for children



**1171**  
Fig. 39R  
upper molars right  
for children



**1172**  
Fig. 39L  
upper molars left  
for children



**1173**  
Fig. 41  
upper roots

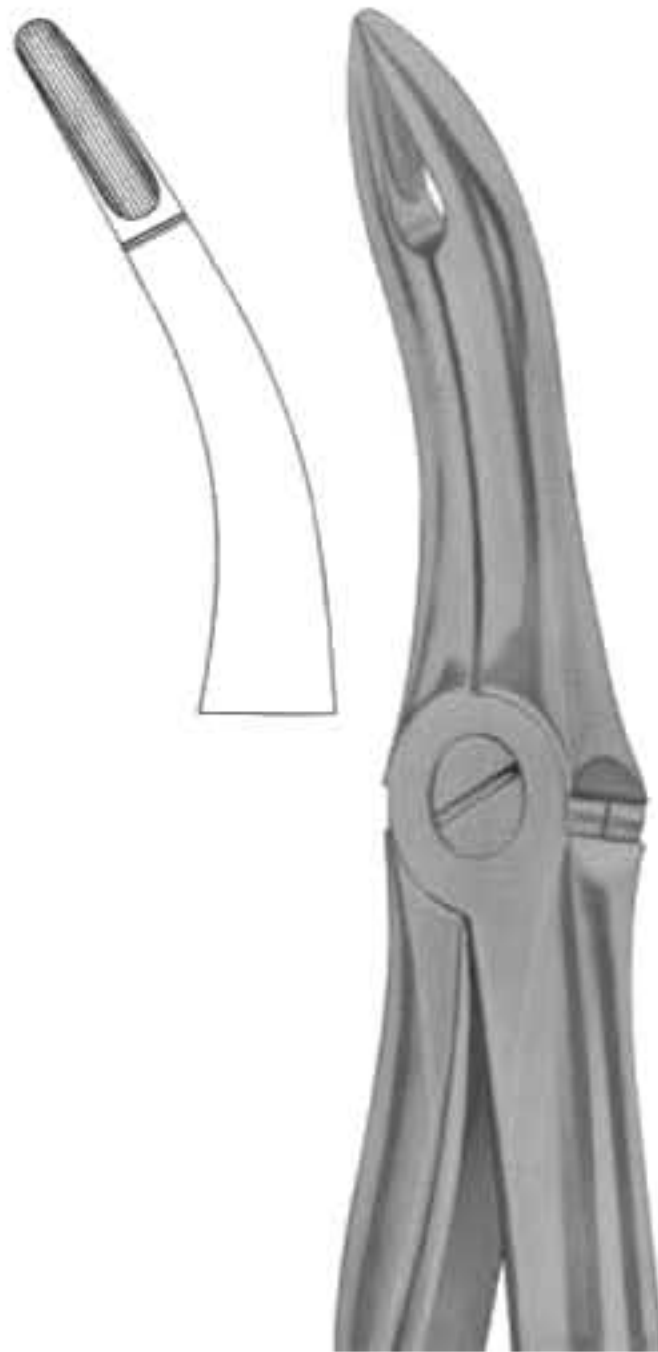

**1174**  
Fig. 44  
upper roots

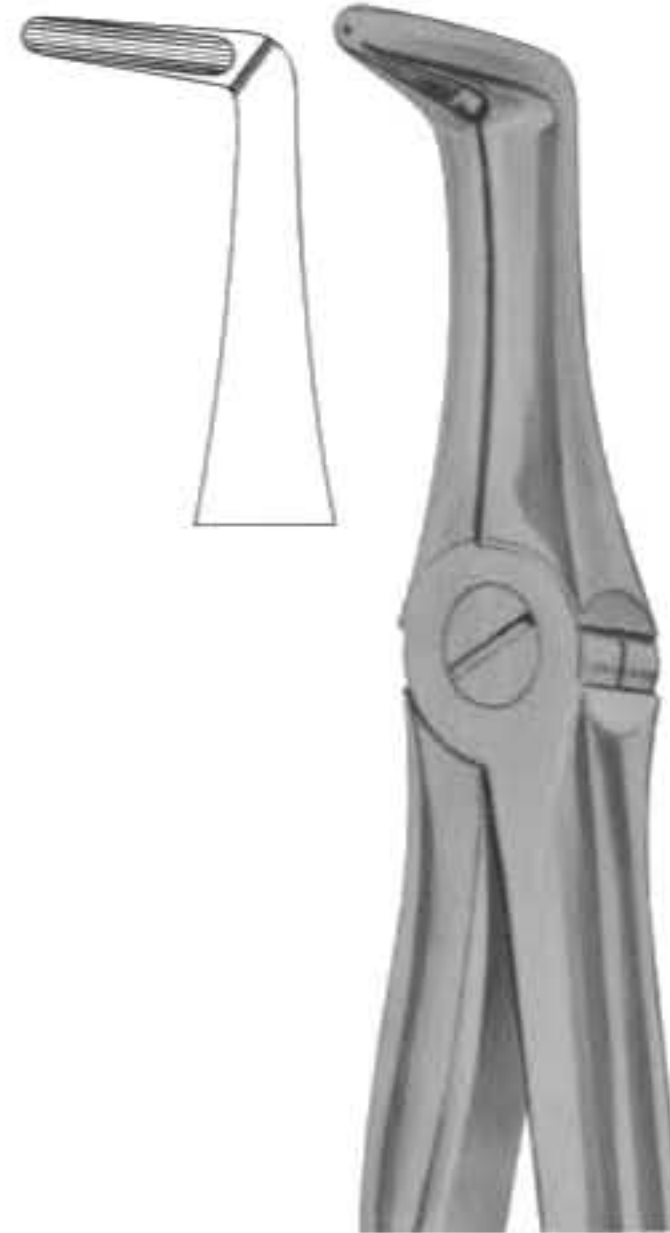

**1175**  
Fig. 45  
lower roots

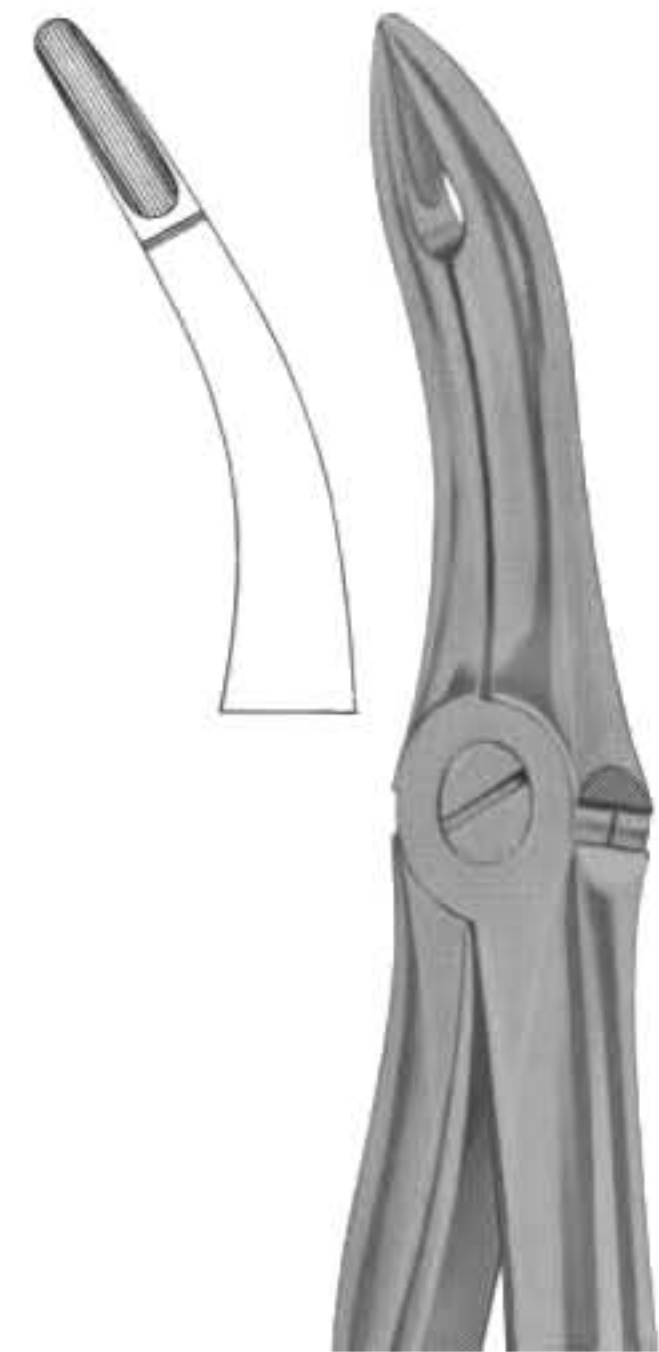

**1176**  
Fig. 48  
lower roots

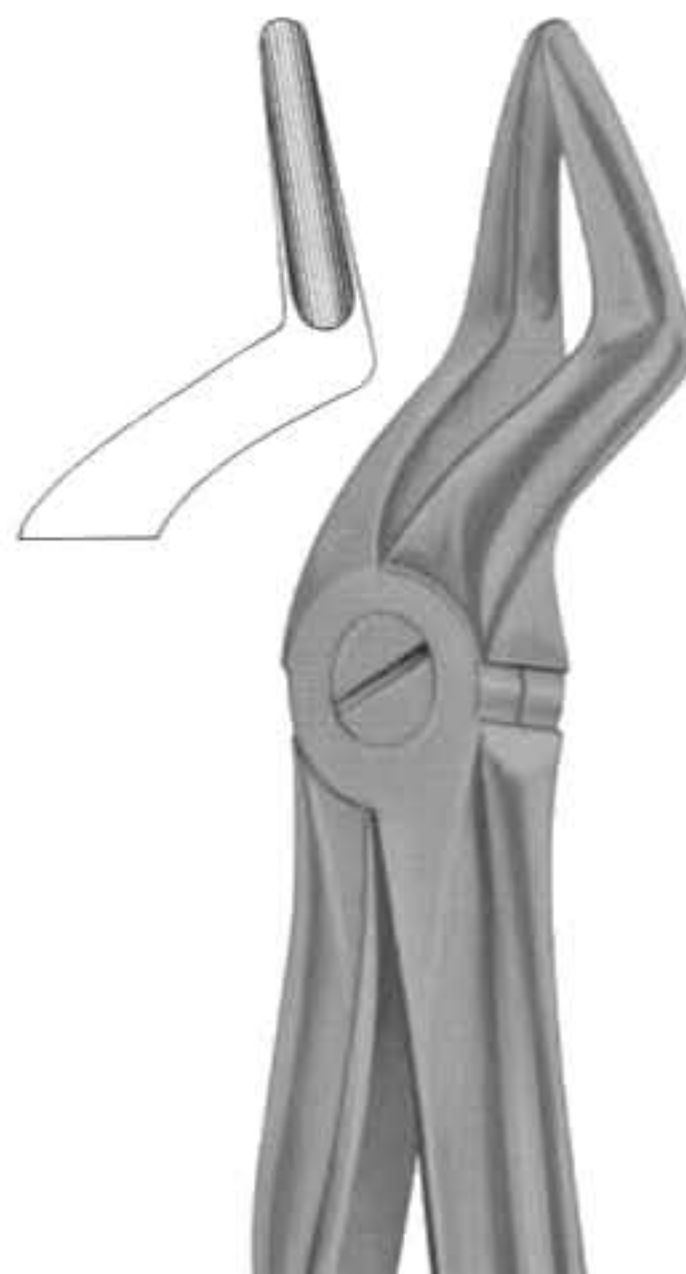

**1177**  
Fig. 51  
upper roots

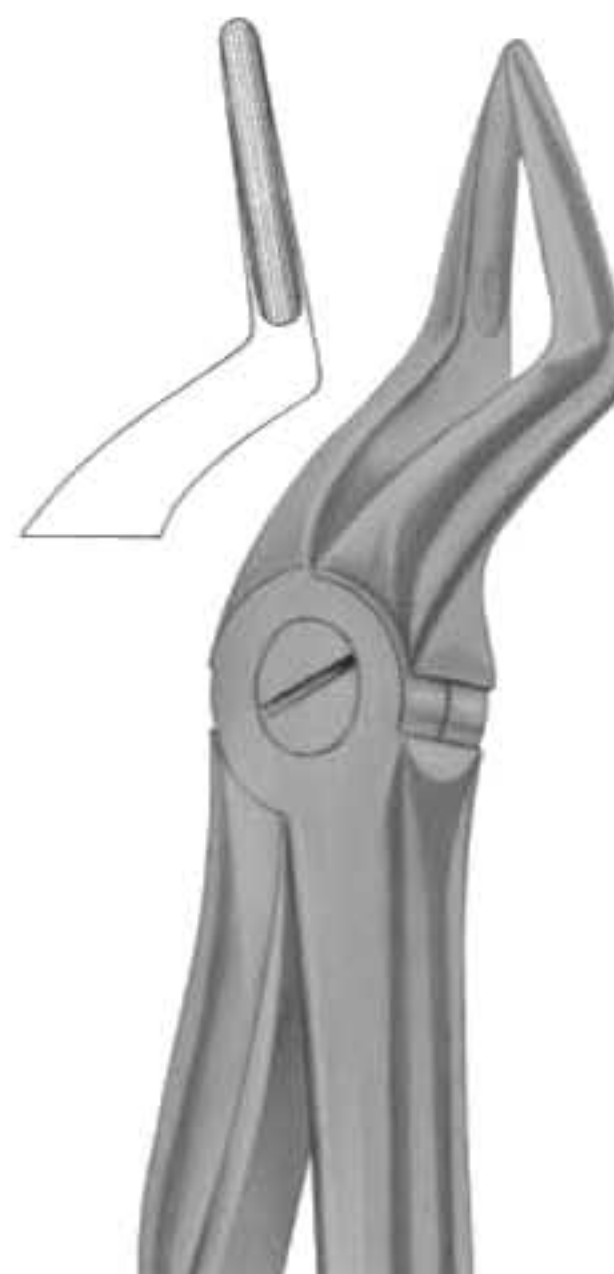

**1178**  
Fig. 51A  
upper roots



**1179**  
Fig. 51S  
upper roots  
for children



**1180**  
Fig. 51L  
upper roots

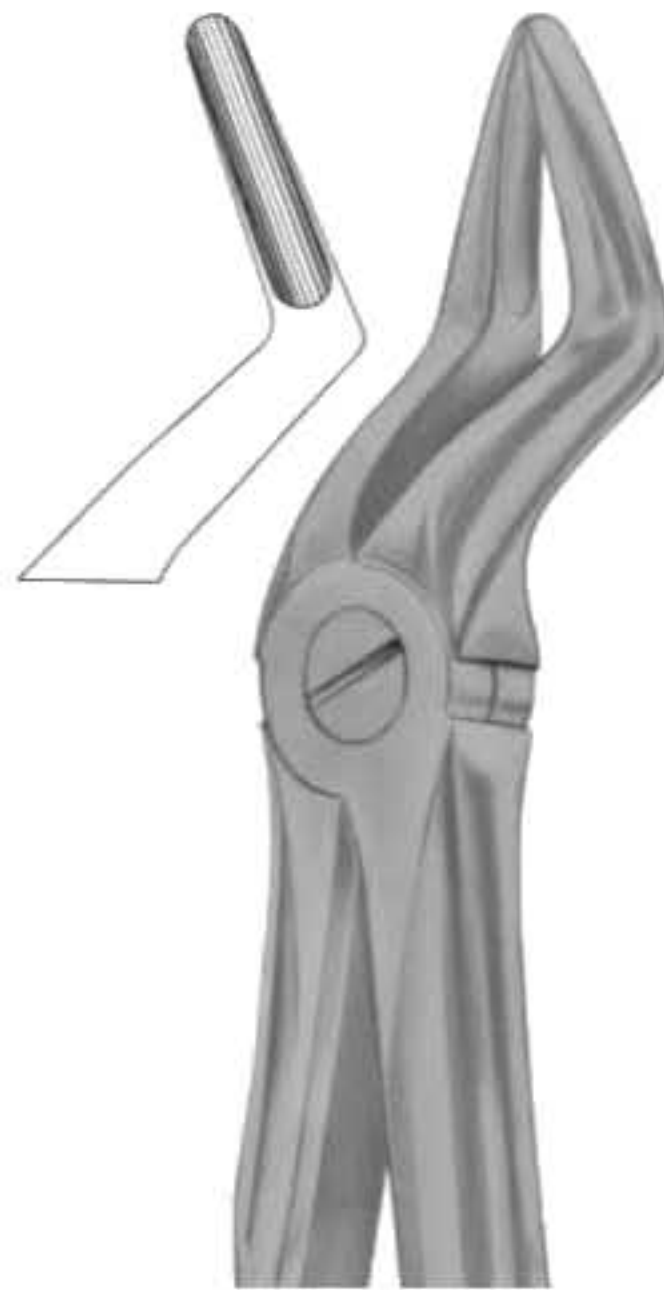

**1181**  
Fig. 52  
upper roots



**1182**  
Fig. 54  
for separating  
upper molars

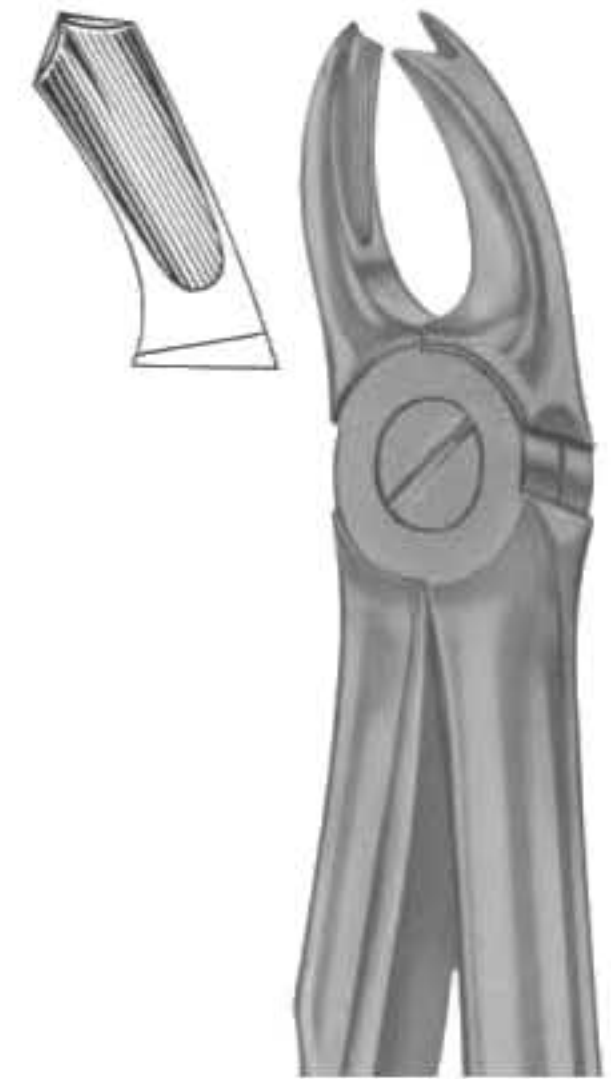

**1183**  
Fig. 65R  
upper molars right



**1184**  
Fig. 65L  
upper molars left



**1185**  
Fig. 67  
upper third molars

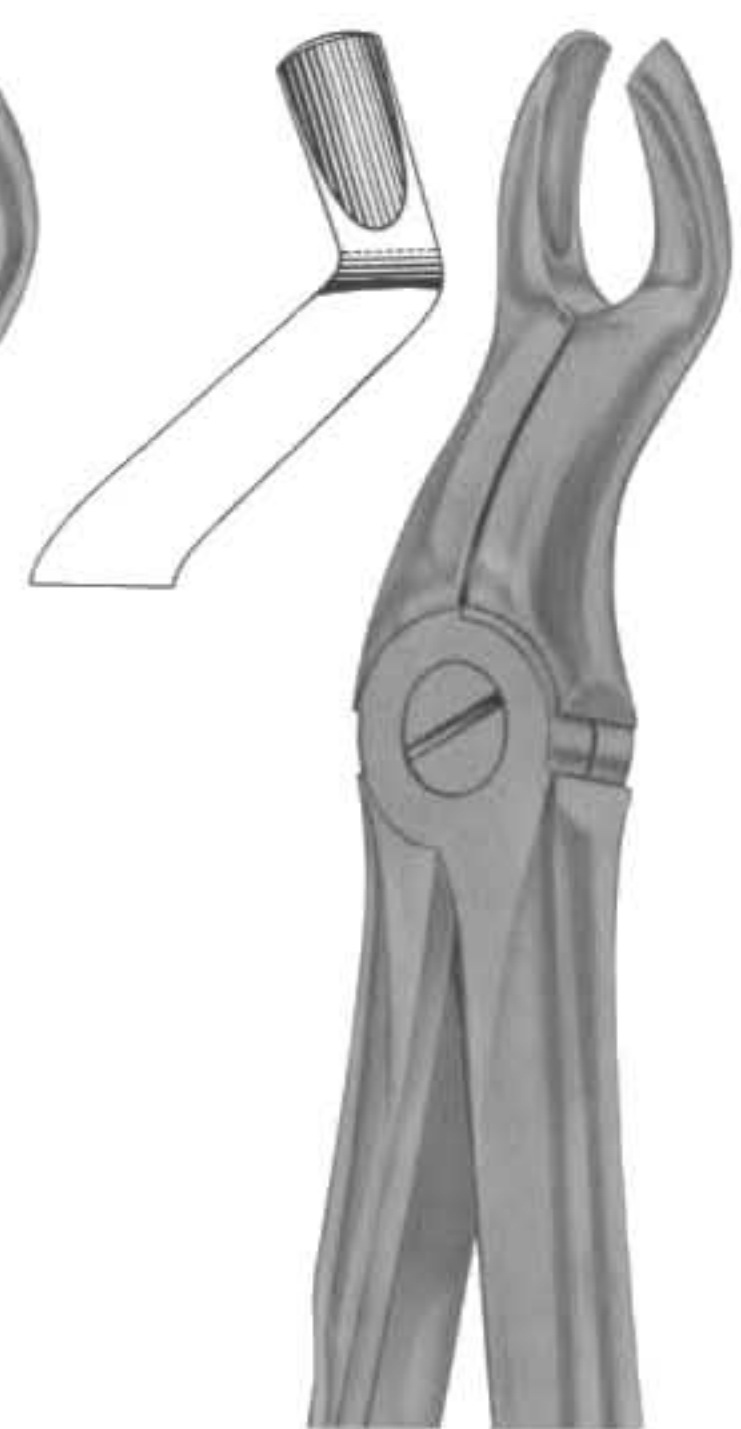

**1186**  
Fig. 67A  
upper third molars



**1187**  
Fig. 67 1/2 R  
upper third molars  
right

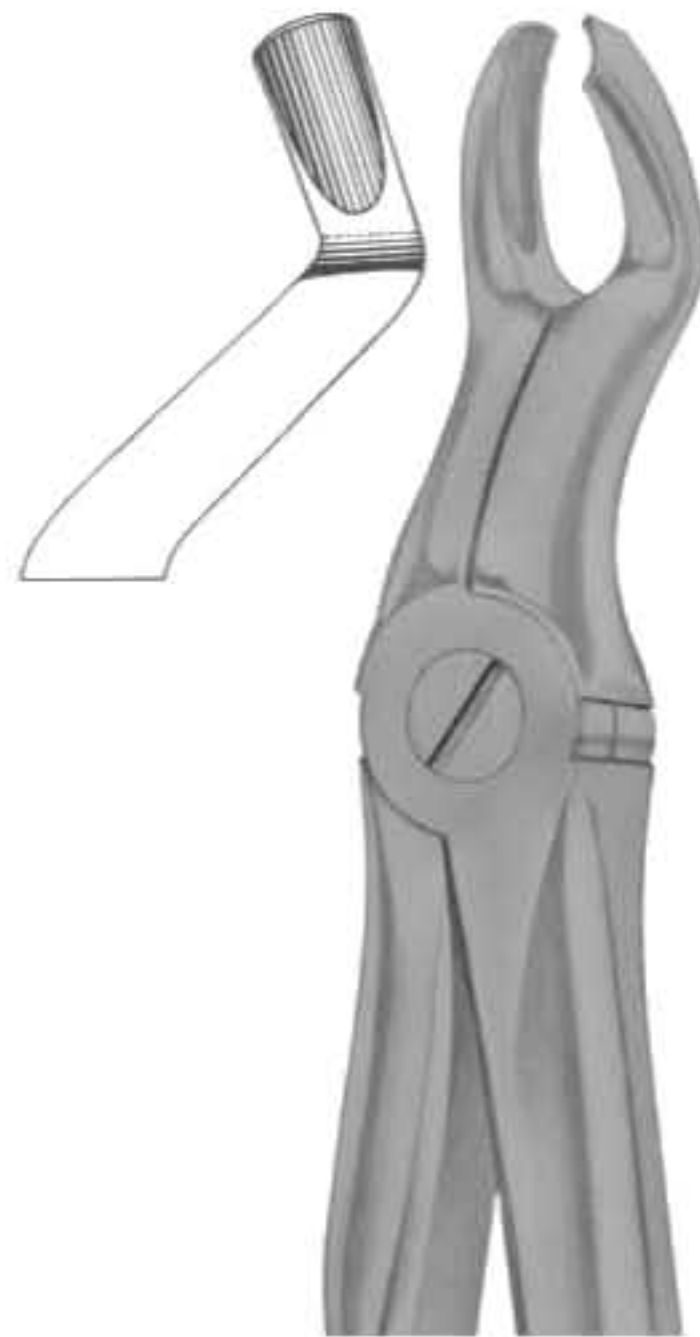

**1188**  
Fig. 67 1/2 L  
upper third molars  
left



**1189**  
Fig. 73  
lower molars

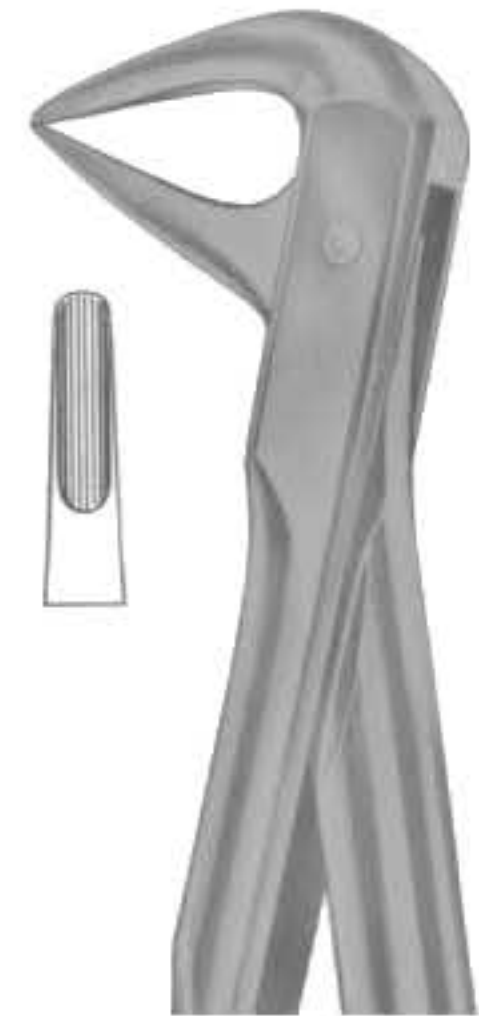

**1190**  
Fig. 74  
lower roots

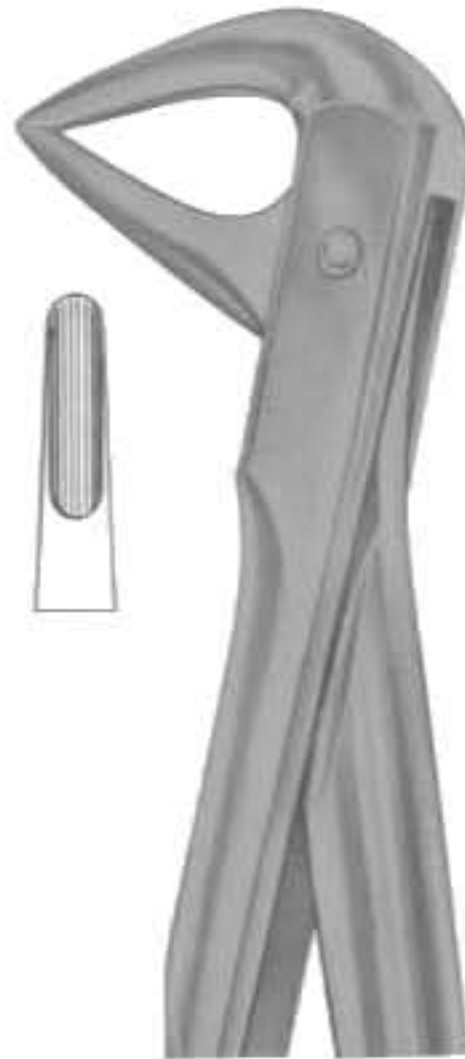

**1191**  
Fig. 74M  
lower roots



**1192**  
Fig. 74N  
lower roots



**1193**  
Fig. 74XN  
lower roots and  
crowded incisors



**1194**  
Fig. 75  
lower premolars



**1195**  
Fig. 76  
upper roots



**1196**  
Fig. 76N  
upper roots



**1197**  
Fig. 81  
lower premolars  
and roots

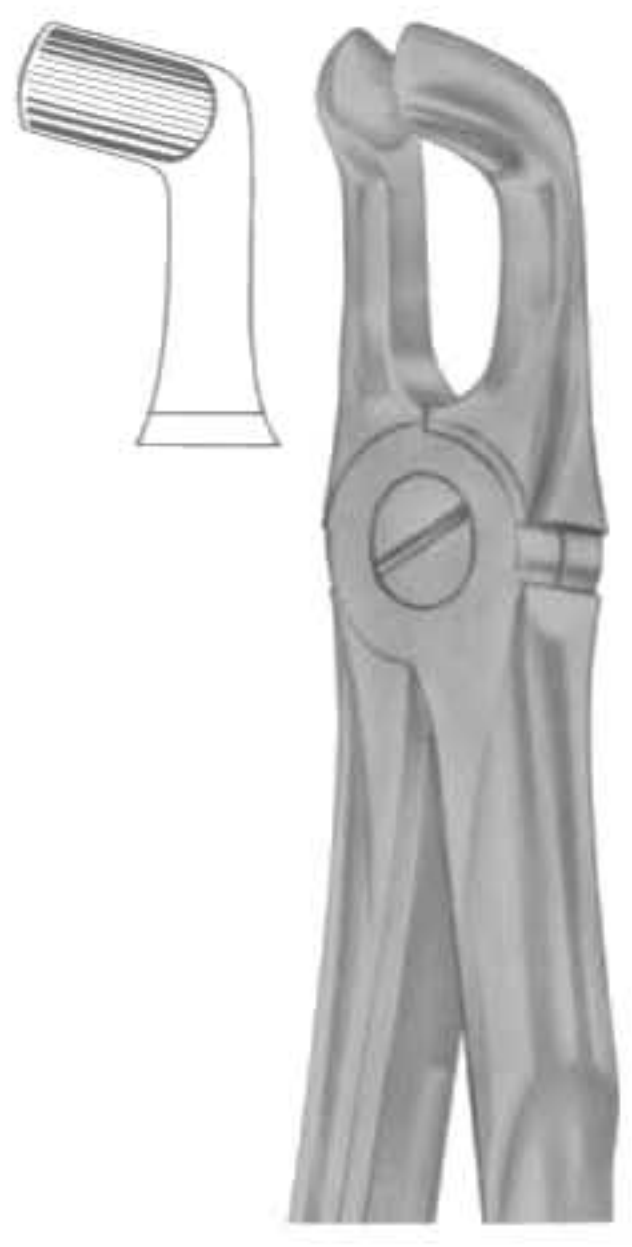

**1198**  
Fig. 76A  
lower third molars



**1199**  
Fig. 79  
lower third molars



**1200**  
Fig. 86A  
lower molars



**1201**  
Fig. 86B  
lower molars



**1202**  
Fig. 86C  
lower molars



**1203**  
Fig. 99  
lower molars



**1204**  
Fig. 99 1/4  
lower molars



**1205**  
Fig. 136  
upper premolars  
and roots



**1206**  
Fig. 143  
lower roots



**1207**  
KLEIN (Fig. 217)  
upper incisors



**1208**  
KLEIN (Fig. 218)  
upper premolars



**1209**  
KLEIN (Fig. 219)  
upper roots



**1210**  
KLEIN (Fig. 220)  
upper molars



**1214**  
ALBRECHT  
Fig. 224  
Deciduous



**1215**  
ALBRECHT  
Fig. 225  
Deciduous



**1211**  
KLEIN (Fig. 221)  
lower incisors



**1212**  
KLEIN (Fig. 222)  
lower molars



**1213**  
KLEIN (Fig. 223)  
lower roots

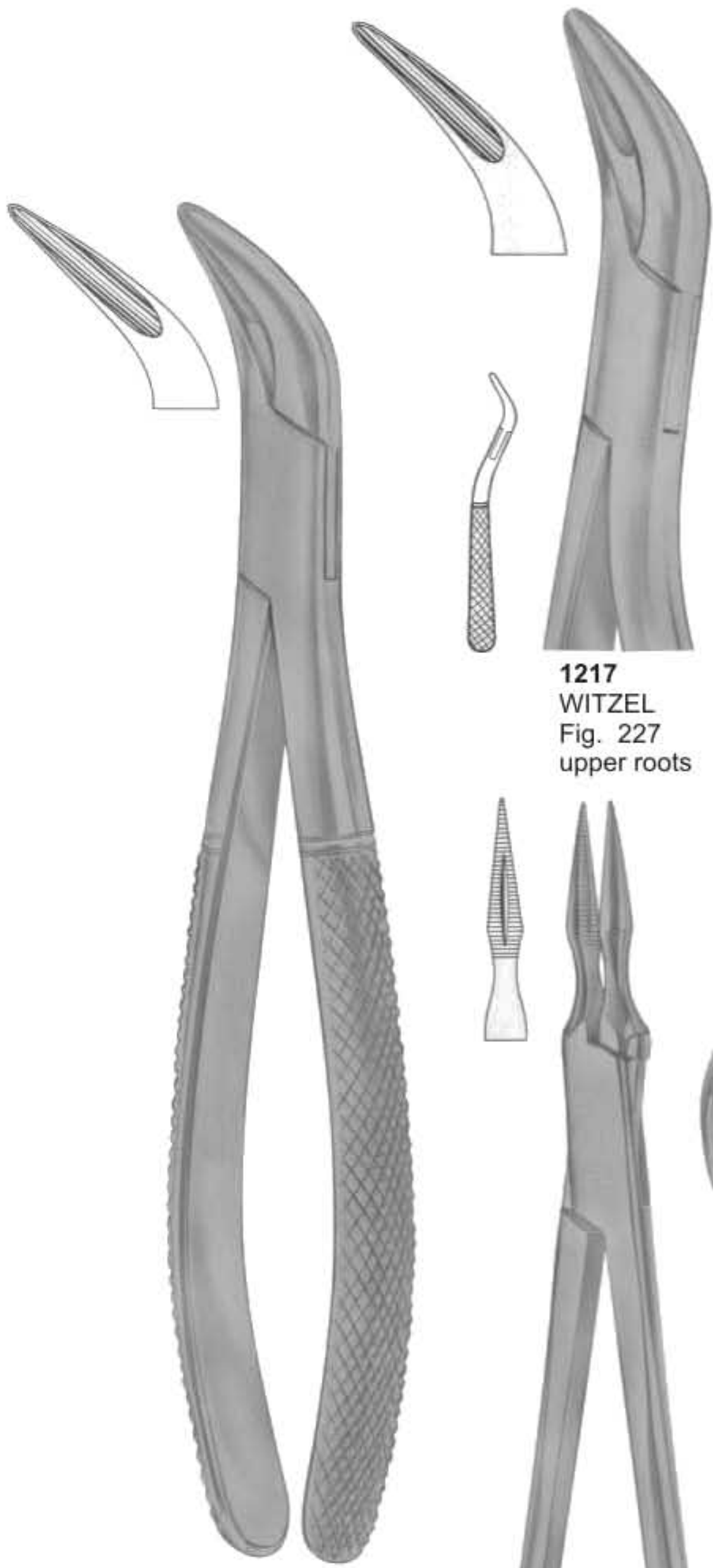

**1216**  
WITZEL  
Fig. 226  
lower roots

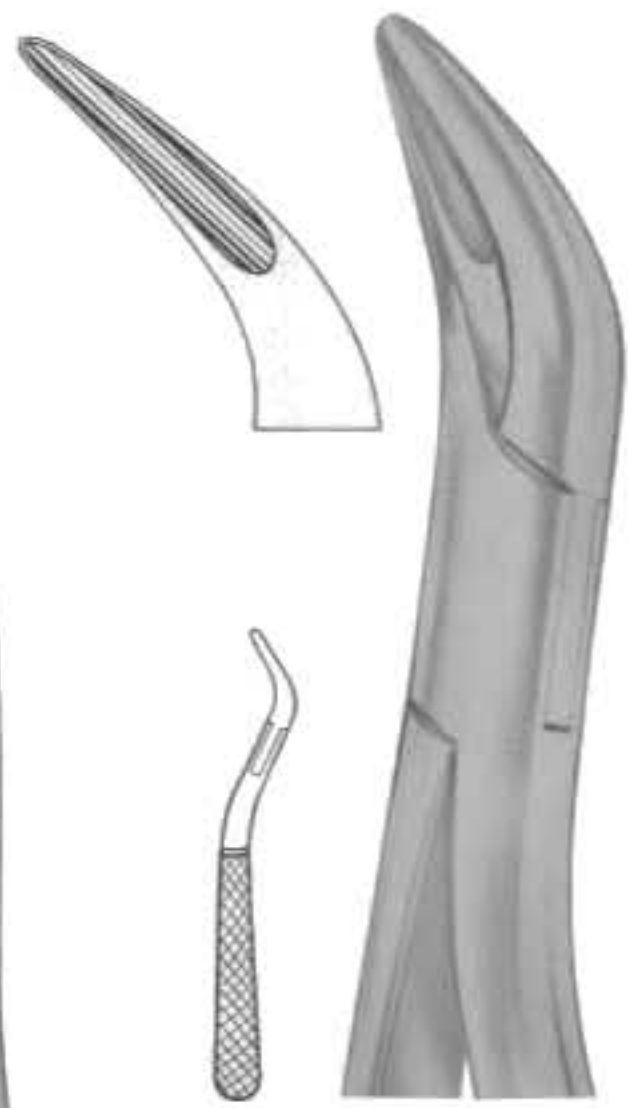

**1217**  
WITZEL  
Fig. 227  
upper roots

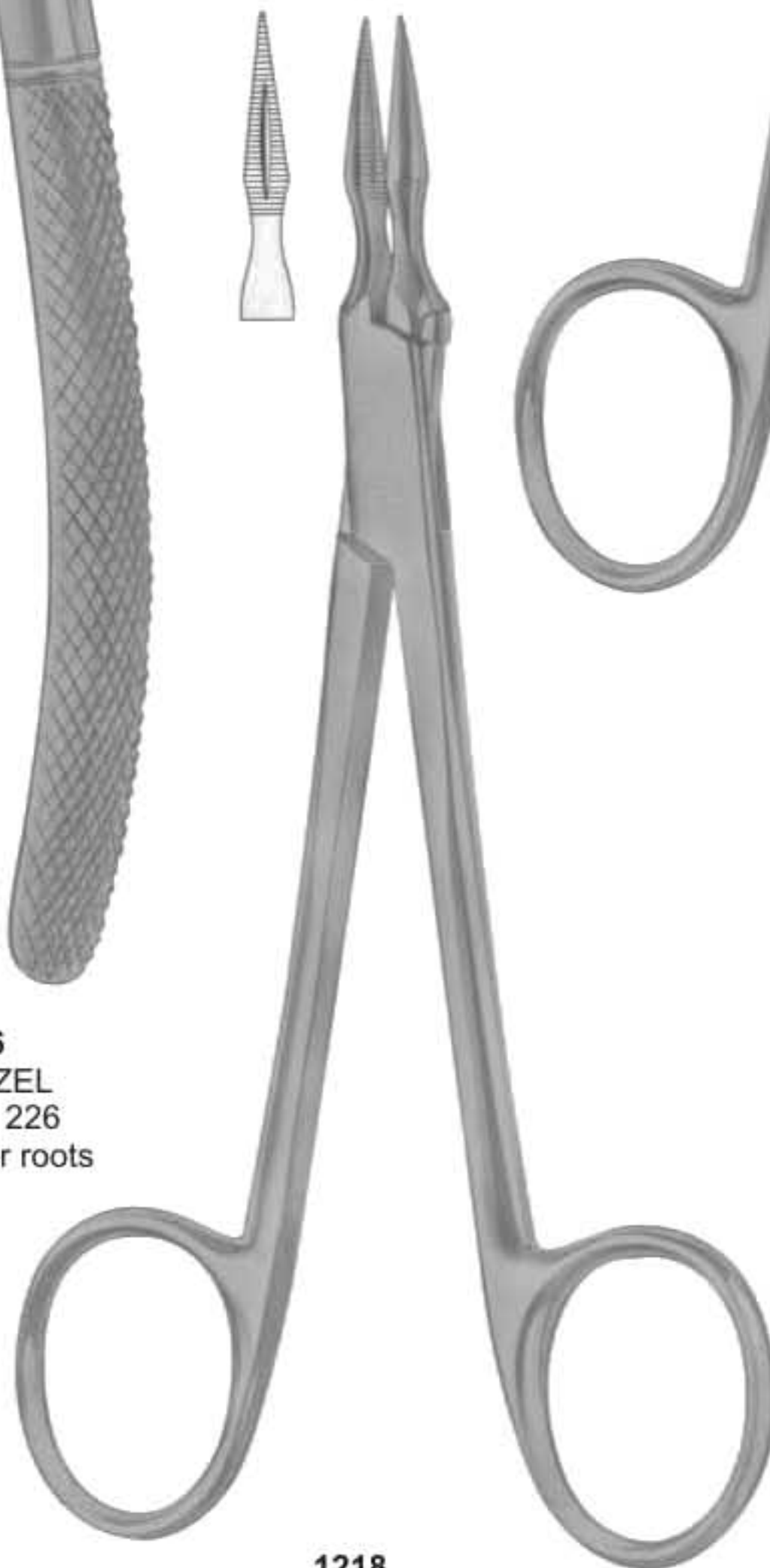

**1218**  
ARTHUR  
Fig. 228  
root fragments



**1219**  
STIEGLITZ  
Fig. 229  
root fragments

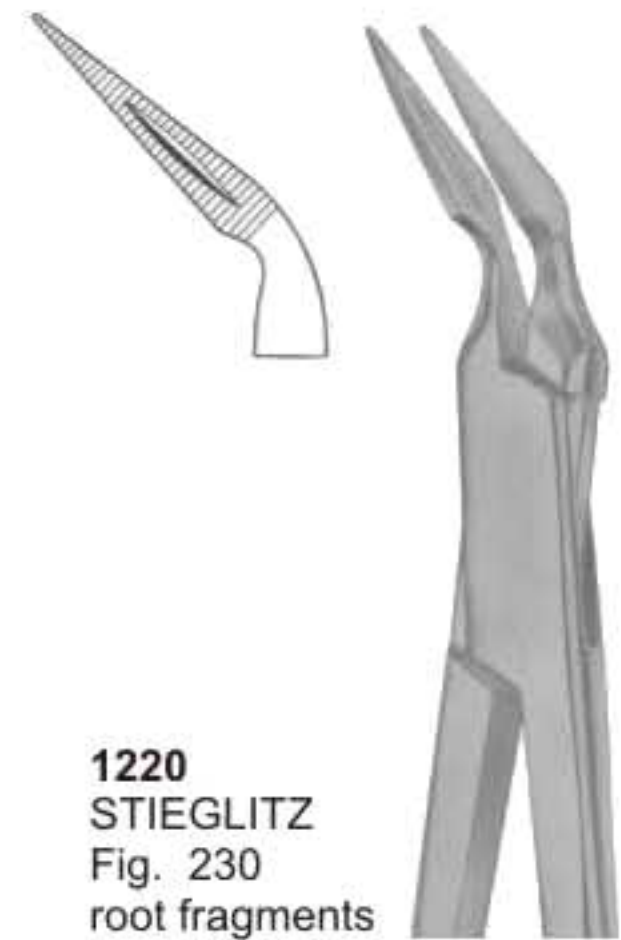

**1220**  
STIEGLITZ  
Fig. 230  
root fragments



**1221**  
RALK  
Fig. 231  
root fragments





**1222**  
W1-WINTER  
upper centrals  
and canines

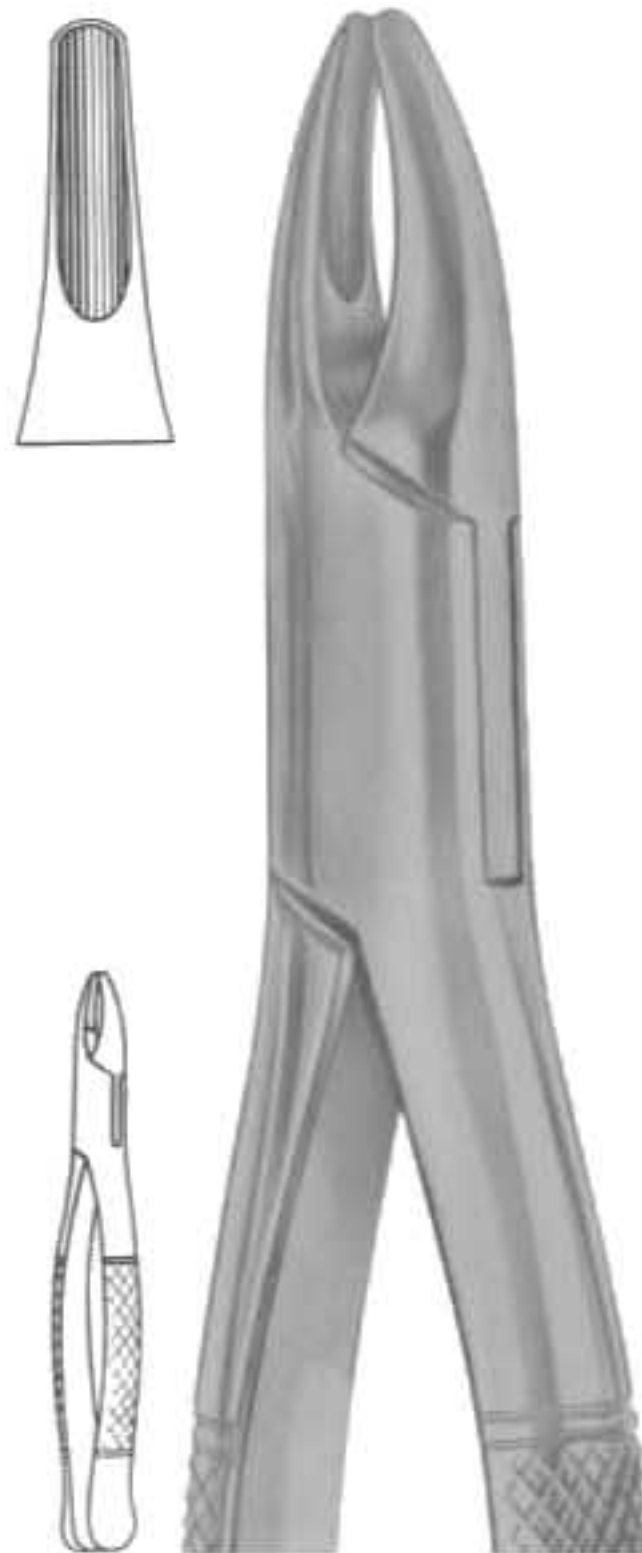

**1223**  
Fig. 1  
upper incisors and roots

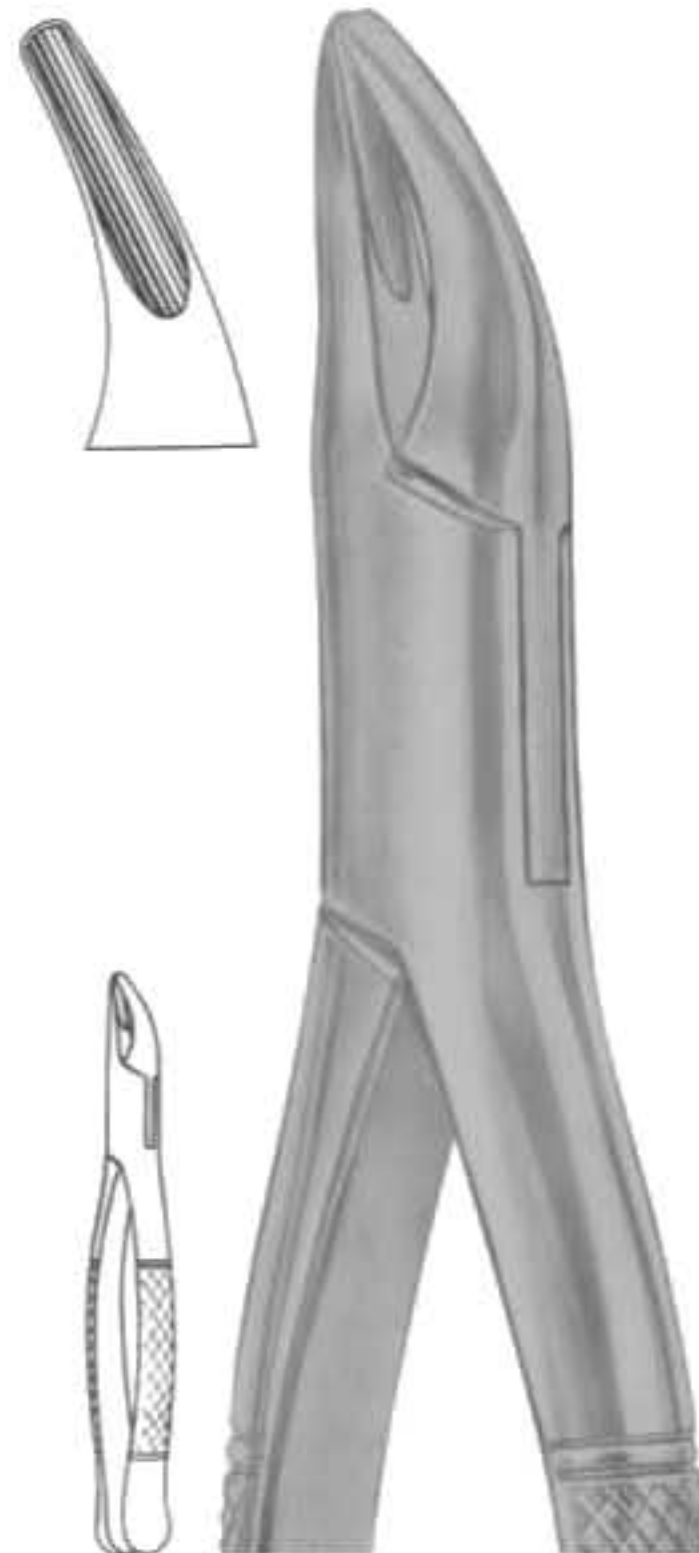

**1224**  
Fig. 2  
upper and lower roots

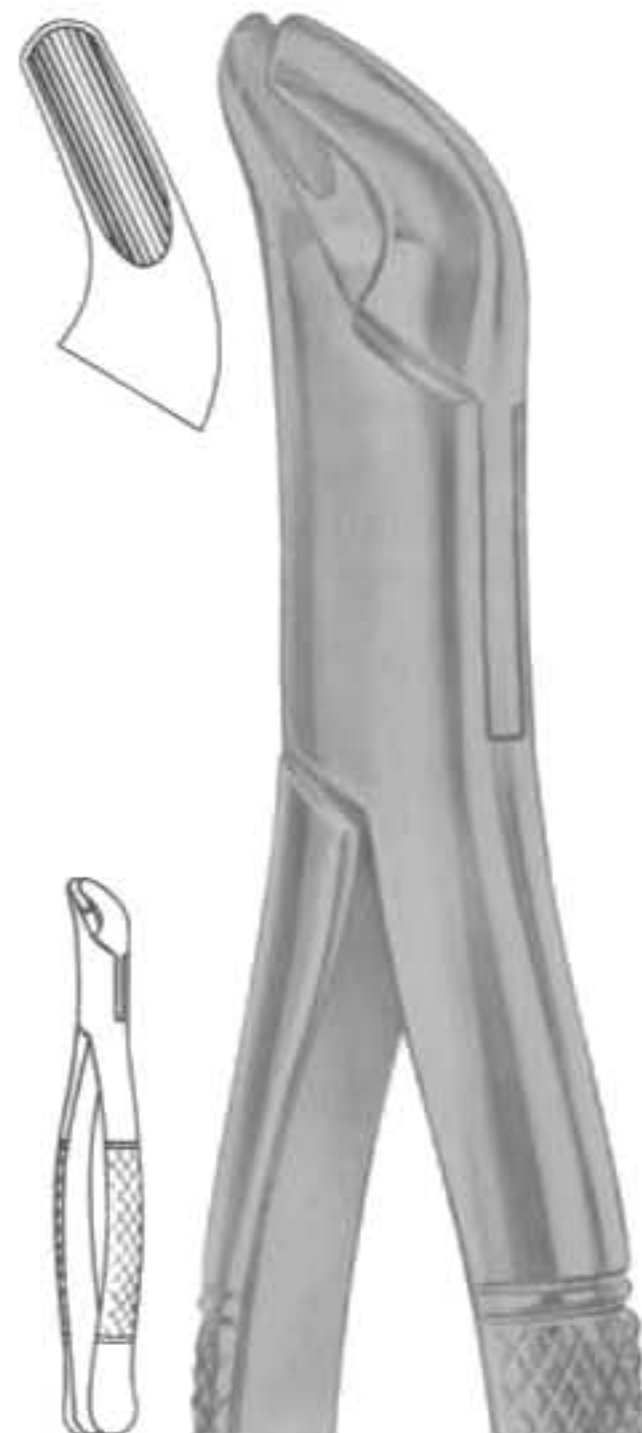

**1225**  
Fig. 4  
upper and lower premolars

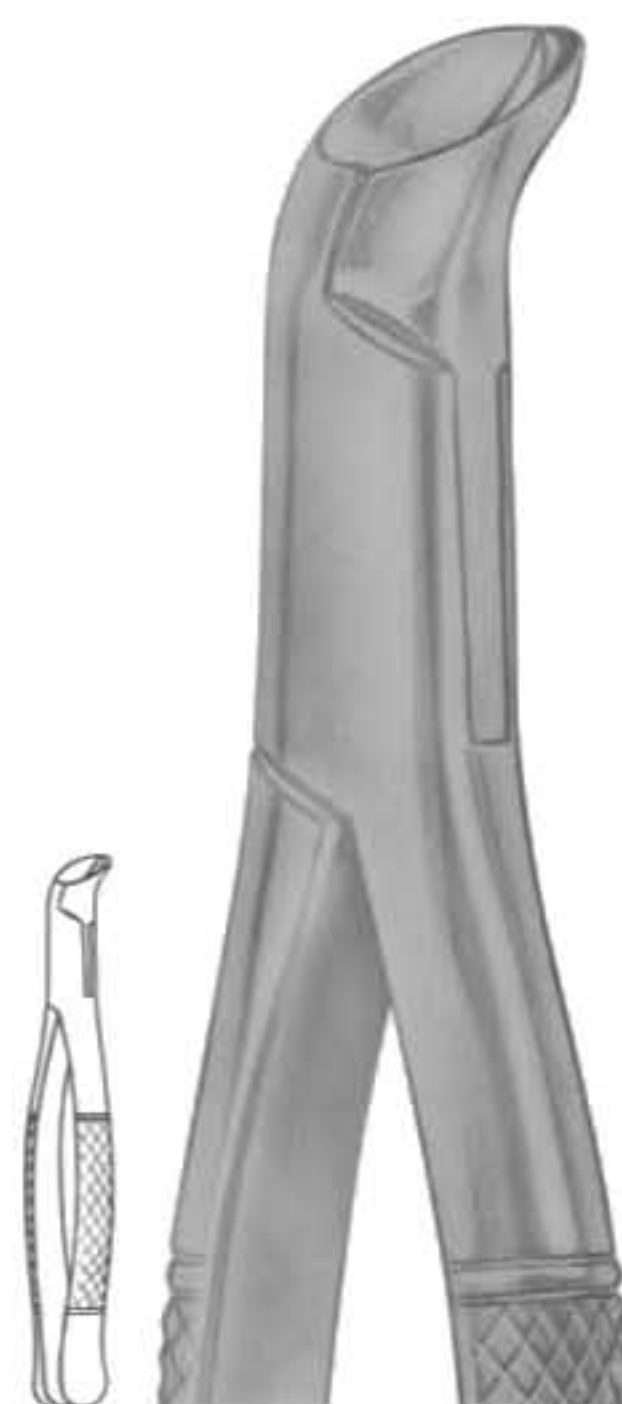

**1226**  
PHYSICK  
Fig. 5  
lower third molars



**1227**  
Fig. 6  
separating  
forceps



**1228**  
Fig. 7  
upper roots

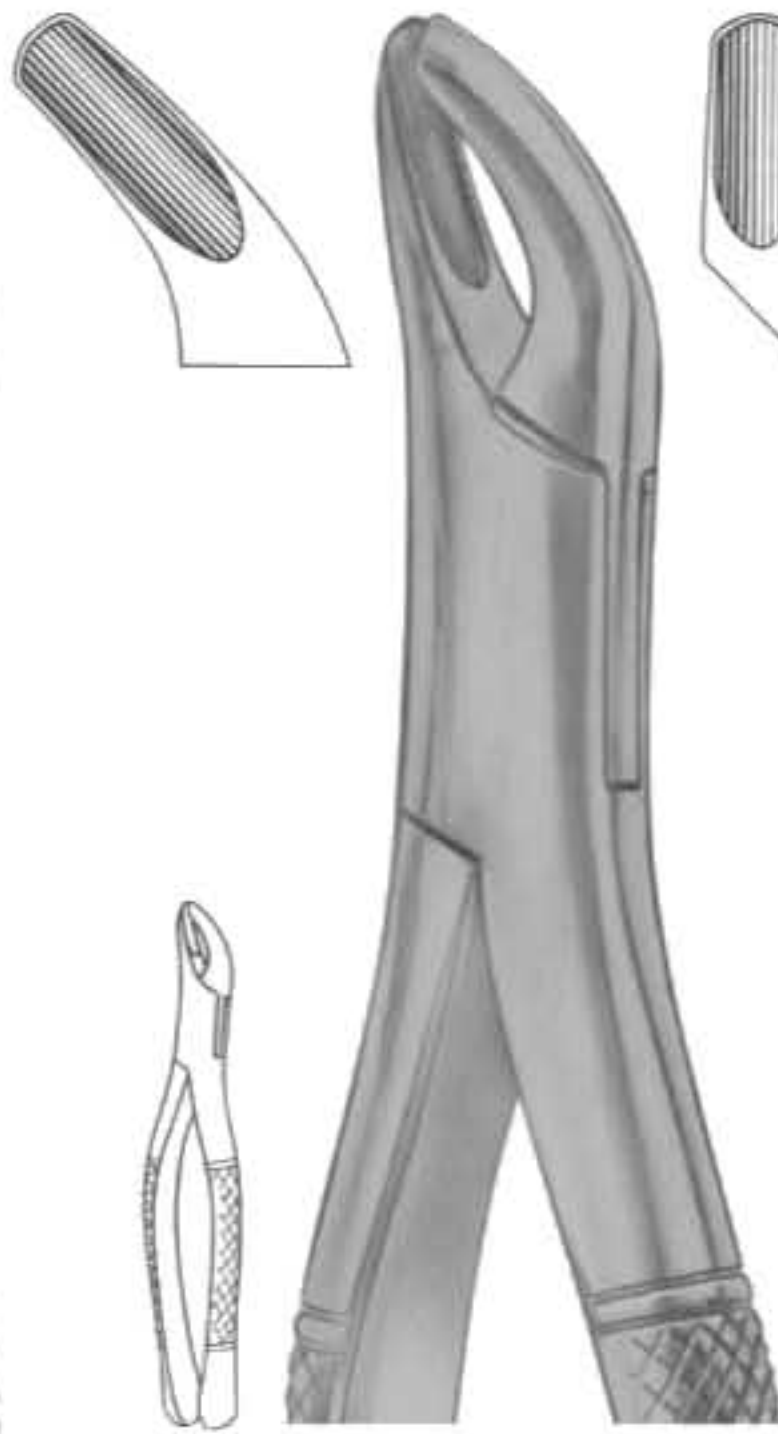

**1229**  
Fig. 8  
upper and lower  
third molars

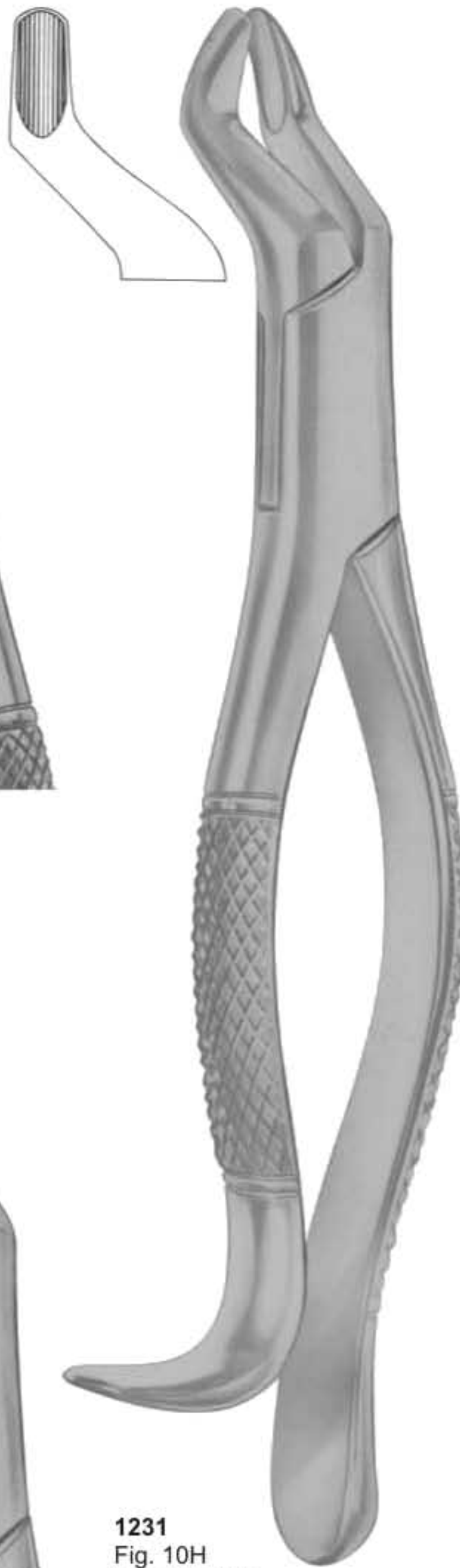

**1231**  
Fig. 10H  
upper molars

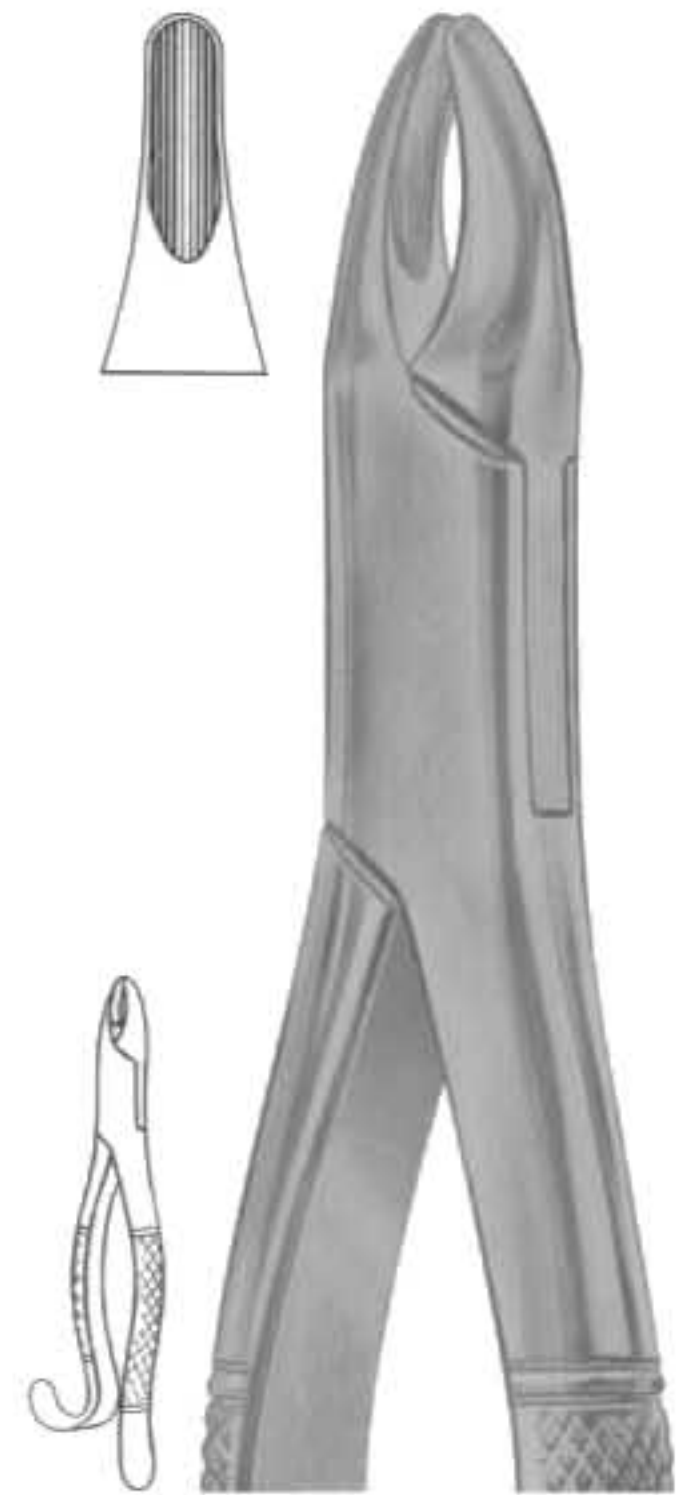

**1232**  
Fig. 13  
upper incisors

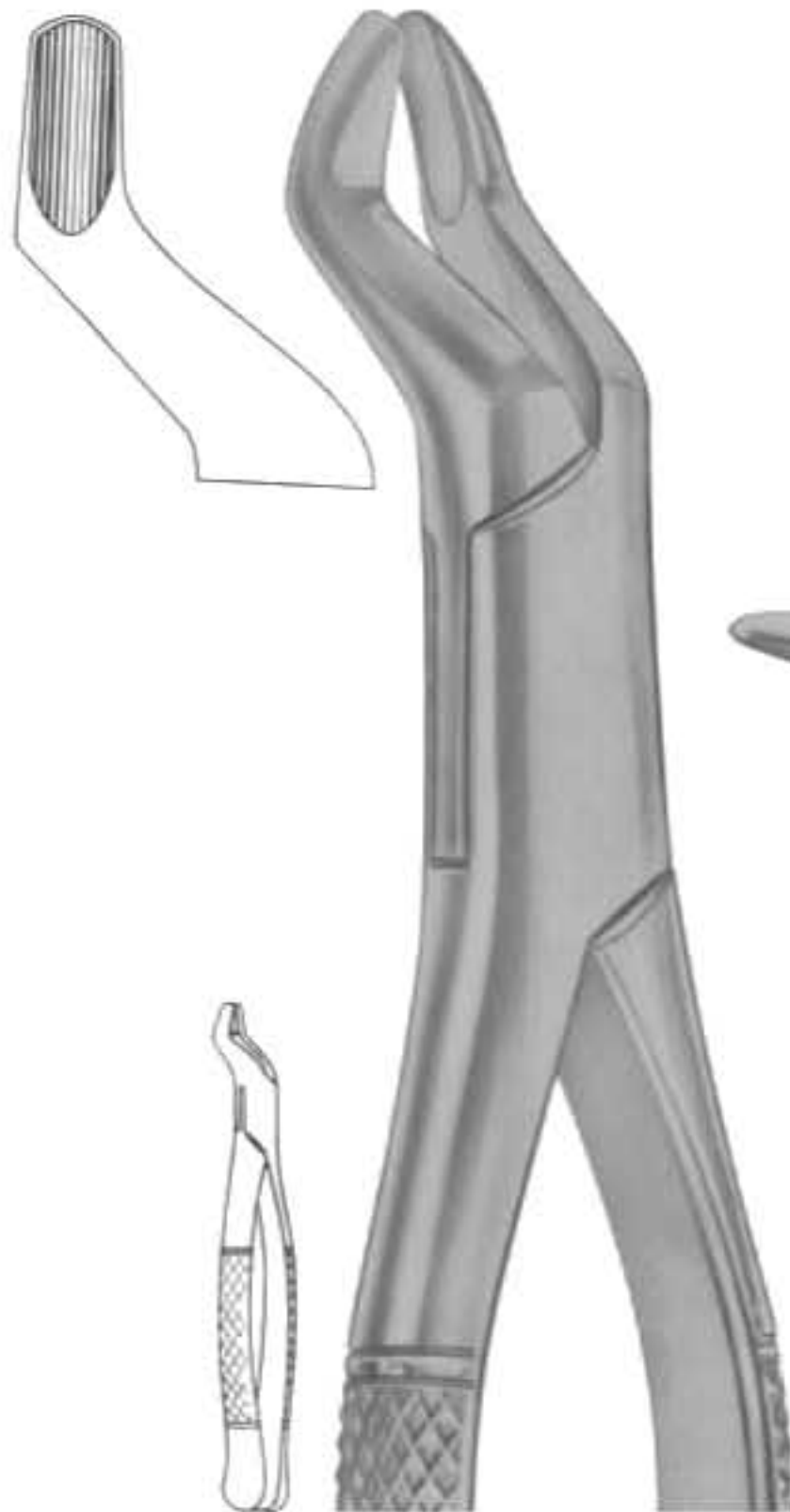

**1230**  
Fig. 10S  
upper molars



**1233**  
Fig. 14  
lower incisors

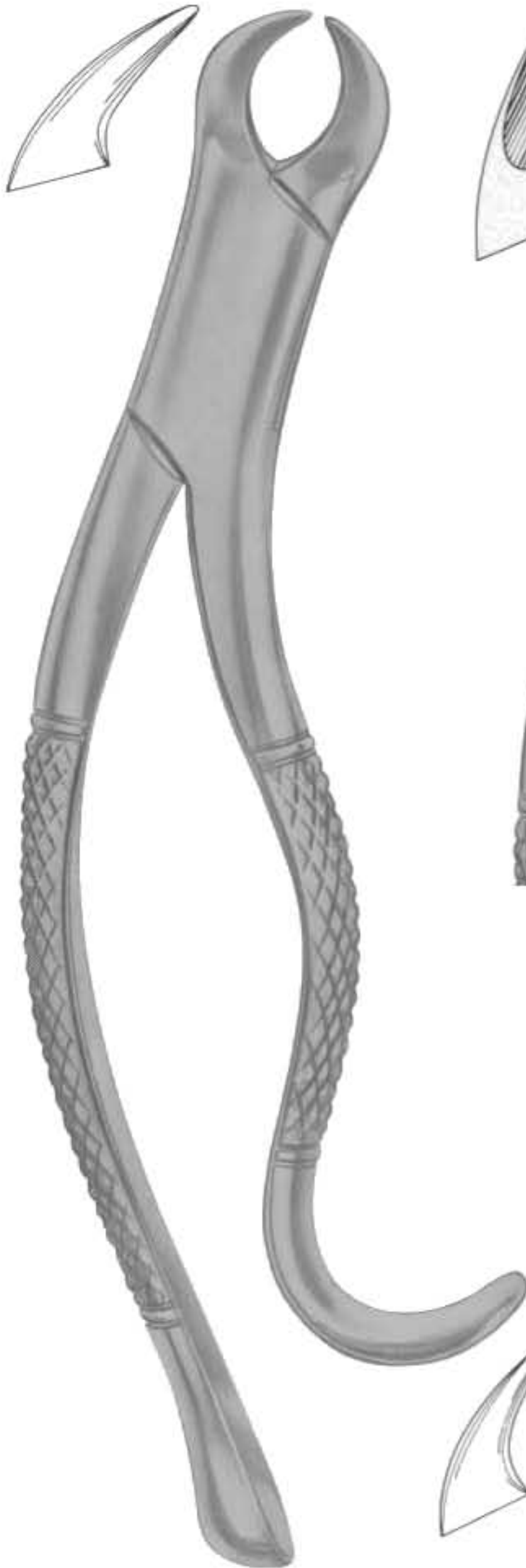

**1234**  
Fig. 16  
lower molars



**1235**  
HARRIS  
Fig. 15  
lower molars

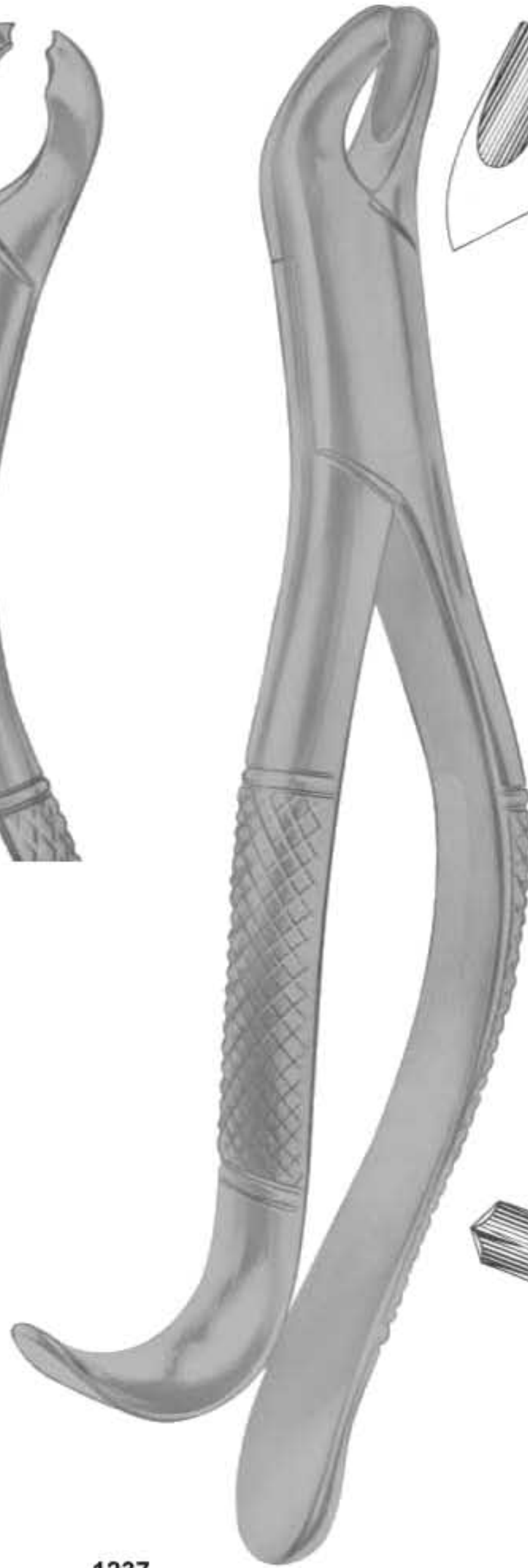

**1237**  
HARRIS  
Fig. 18R  
upper molars right



**1238**  
HARRIS  
Fig. 18L  
upper molars left



**1236**  
Fig. 16S  
lower molars  
for children

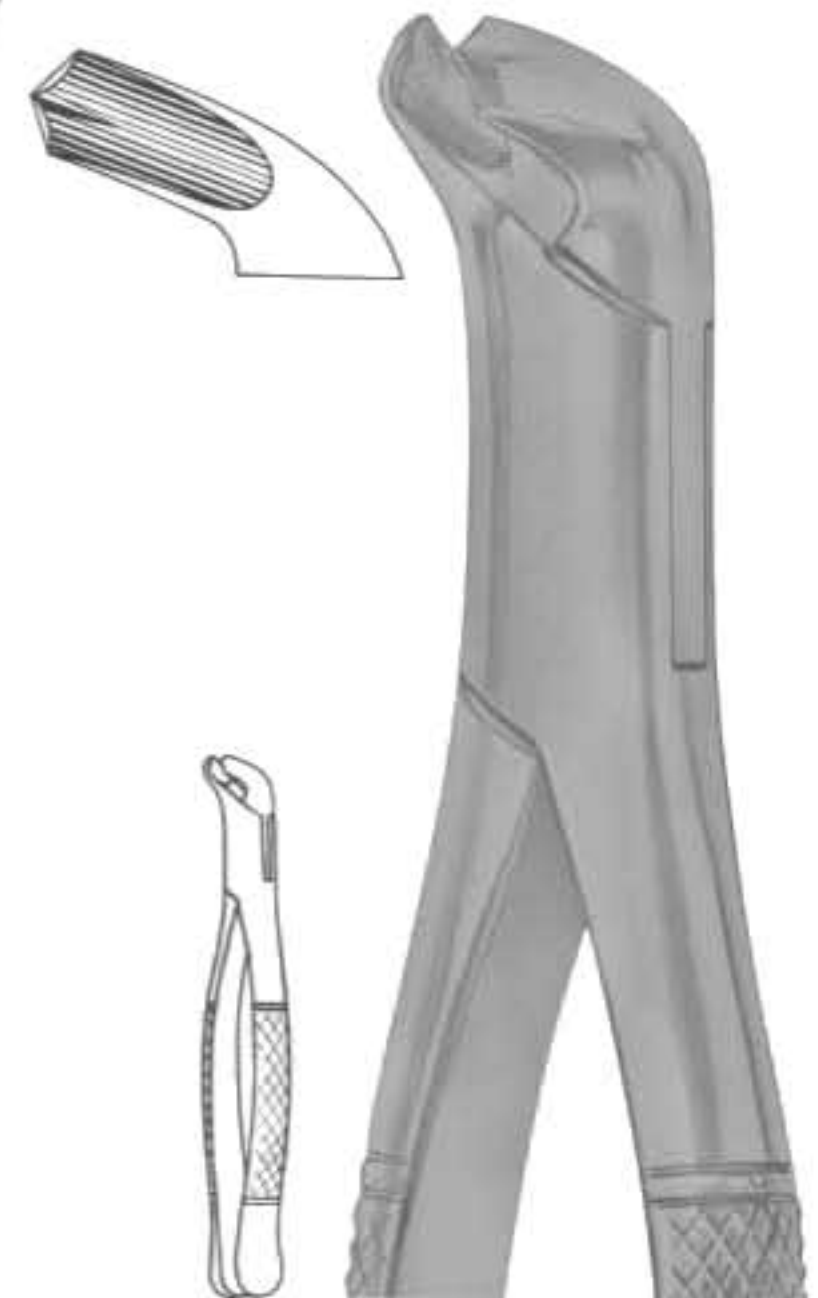

**1239**  
Fig. 17  
lower molars

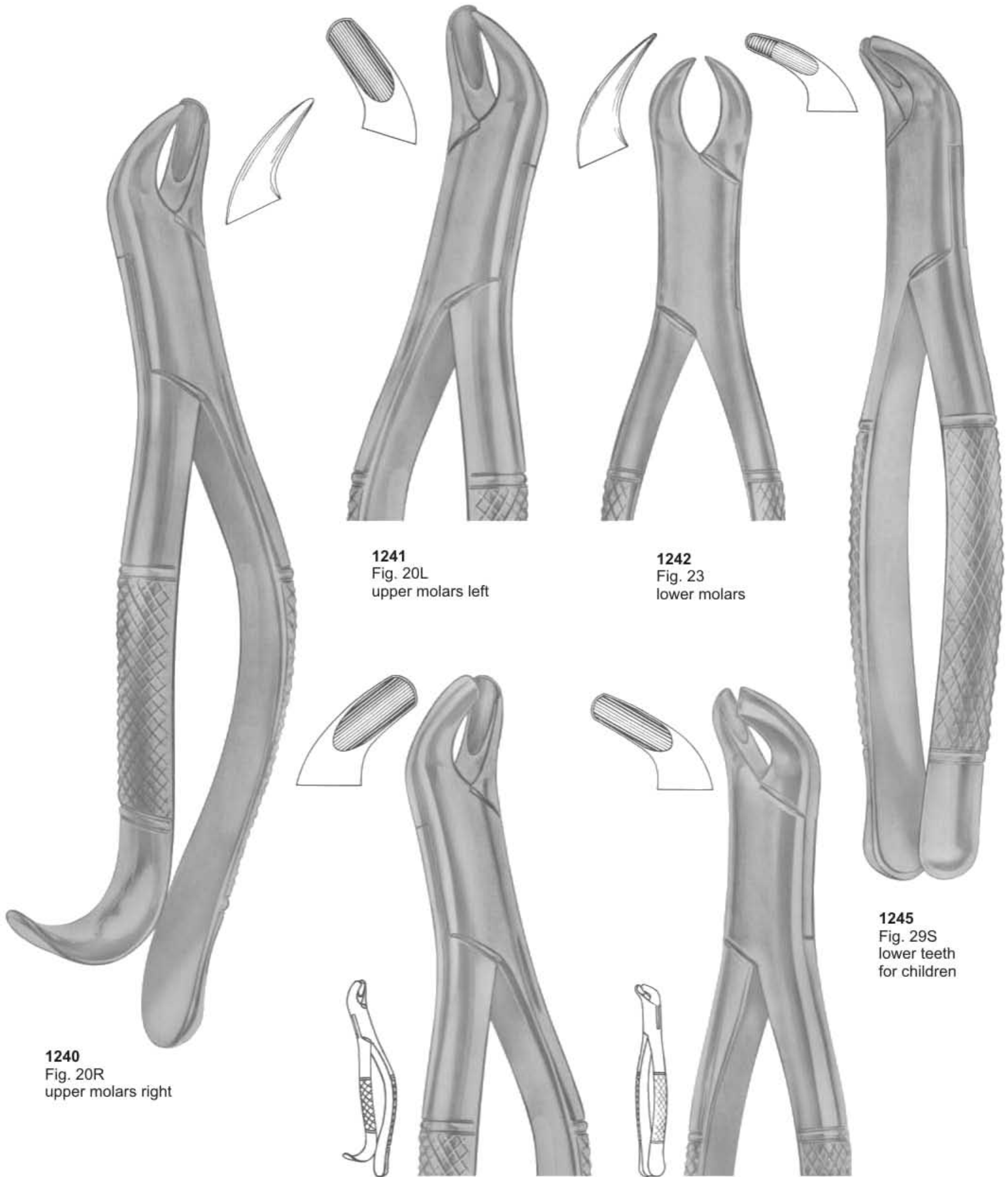

**1240**  
Fig. 20R  
upper molars right

**1241**  
Fig. 20L  
upper molars left

**1242**  
Fig. 23  
lower molars

**1245**  
Fig. 29S  
lower teeth  
for children

**1243**  
Fig. 24  
upper molars

**1244**  
Fig. 27  
lower molars



**1246**  
Fig. 30S  
upper teeth  
for children

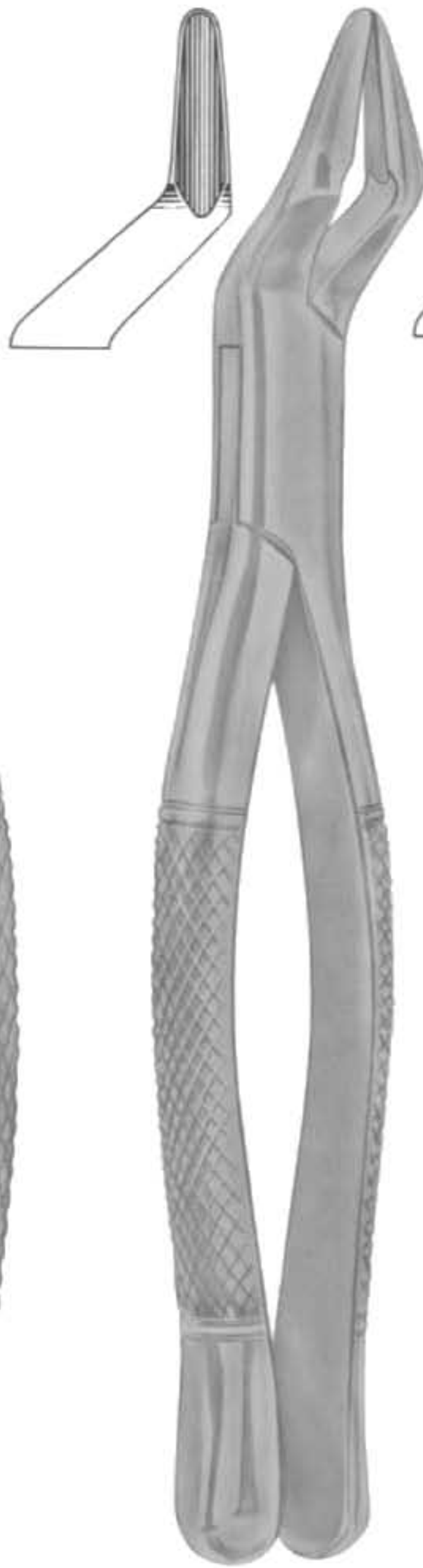

**1247**  
PARMLY  
Fig. 32  
upper premolars  
and molars



**1248**  
PARMLY  
Fig. 32A  
upper premolars  
and roots



**1249**  
Fig. 34  
lower anteriors  
and roots

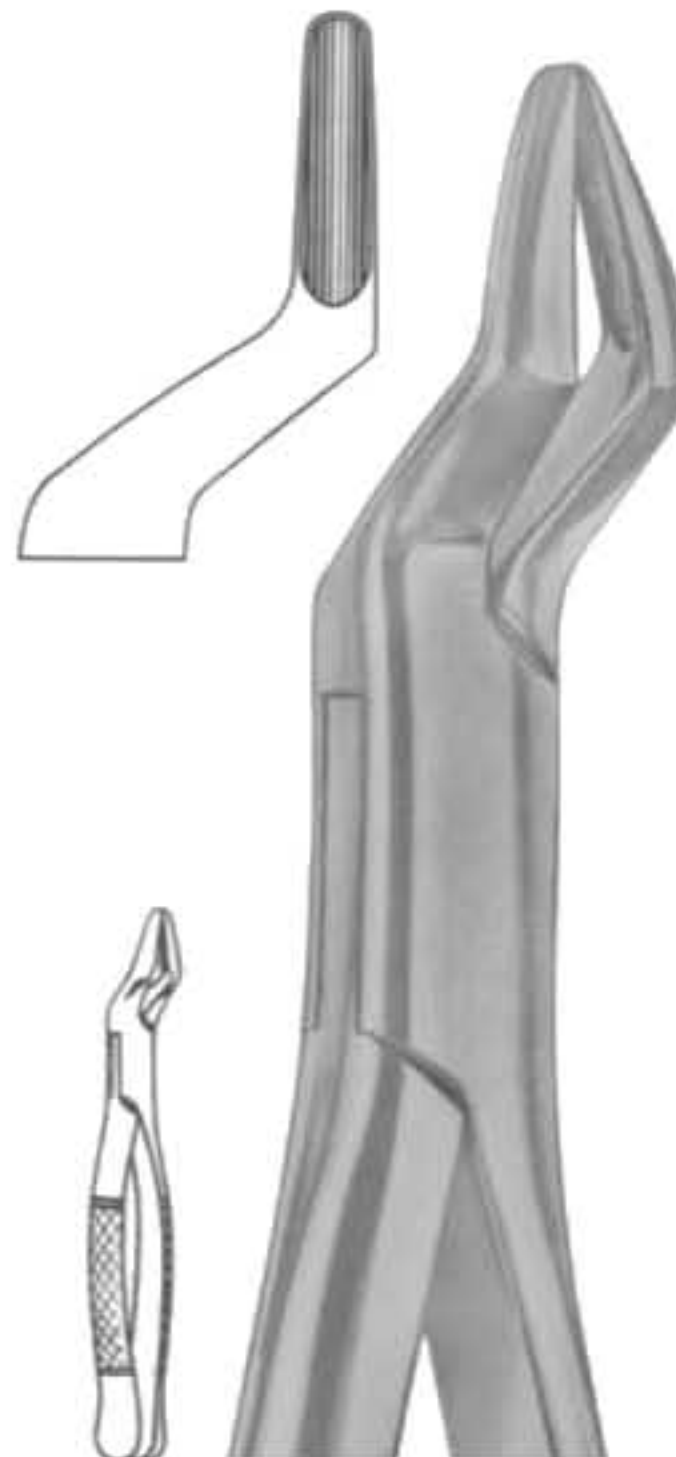

**1250**  
Fig. 35  
upper roots



**1251**  
Fig. 36  
lower anteriors  
and roots



**1252**  
Fig. 37  
lower anteriors  
and roots

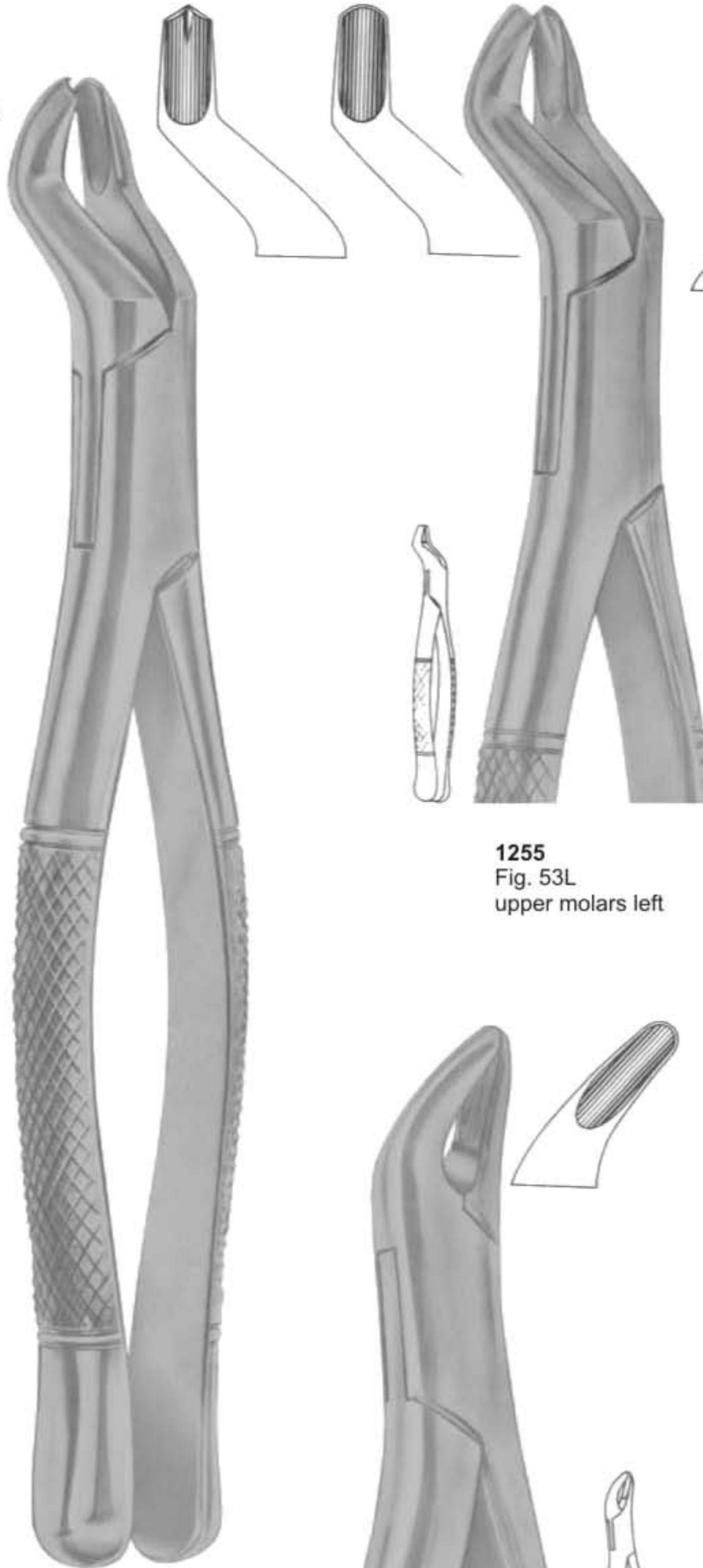

**1255**  
Fig. 53L  
upper molars left

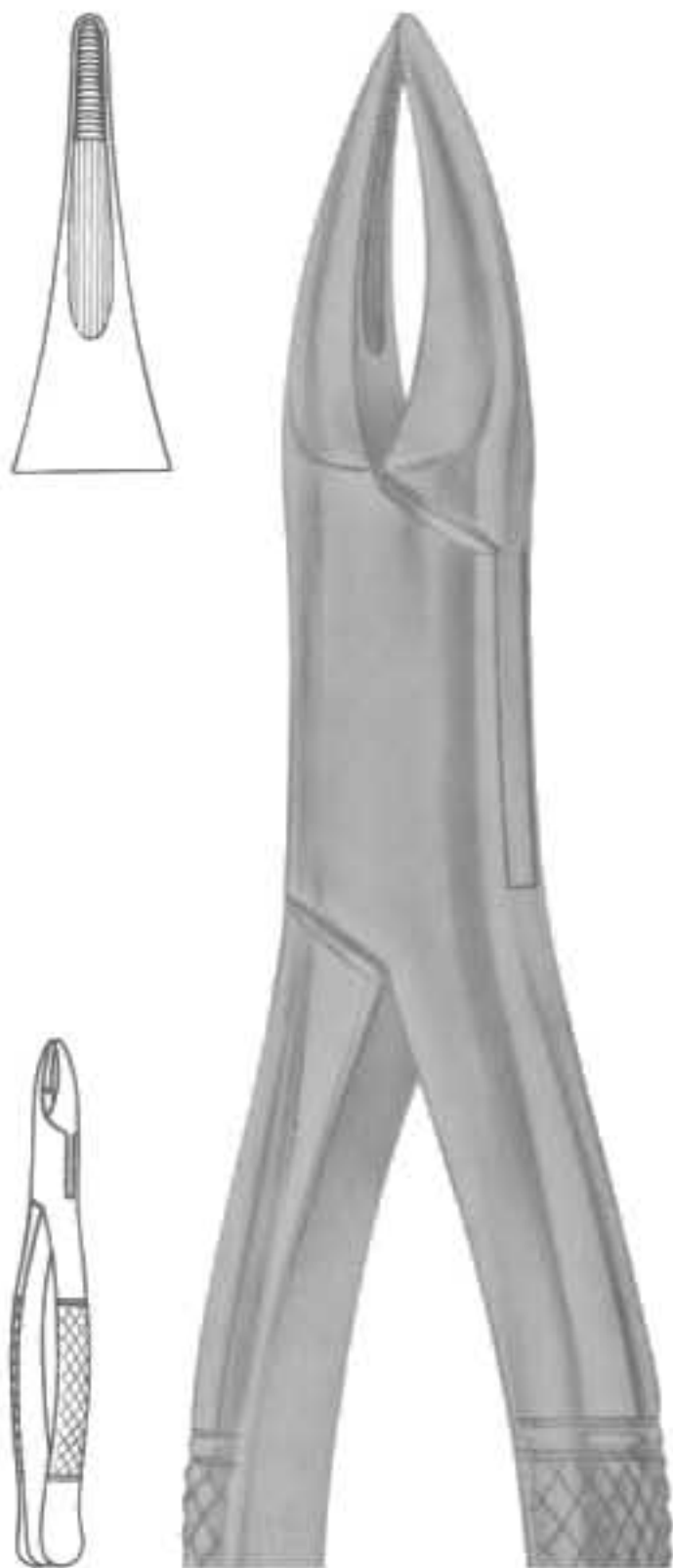

**1253**  
Fig. 38  
upper anteriors  
and roots

**1254**  
Fig. 53R  
upper molars right

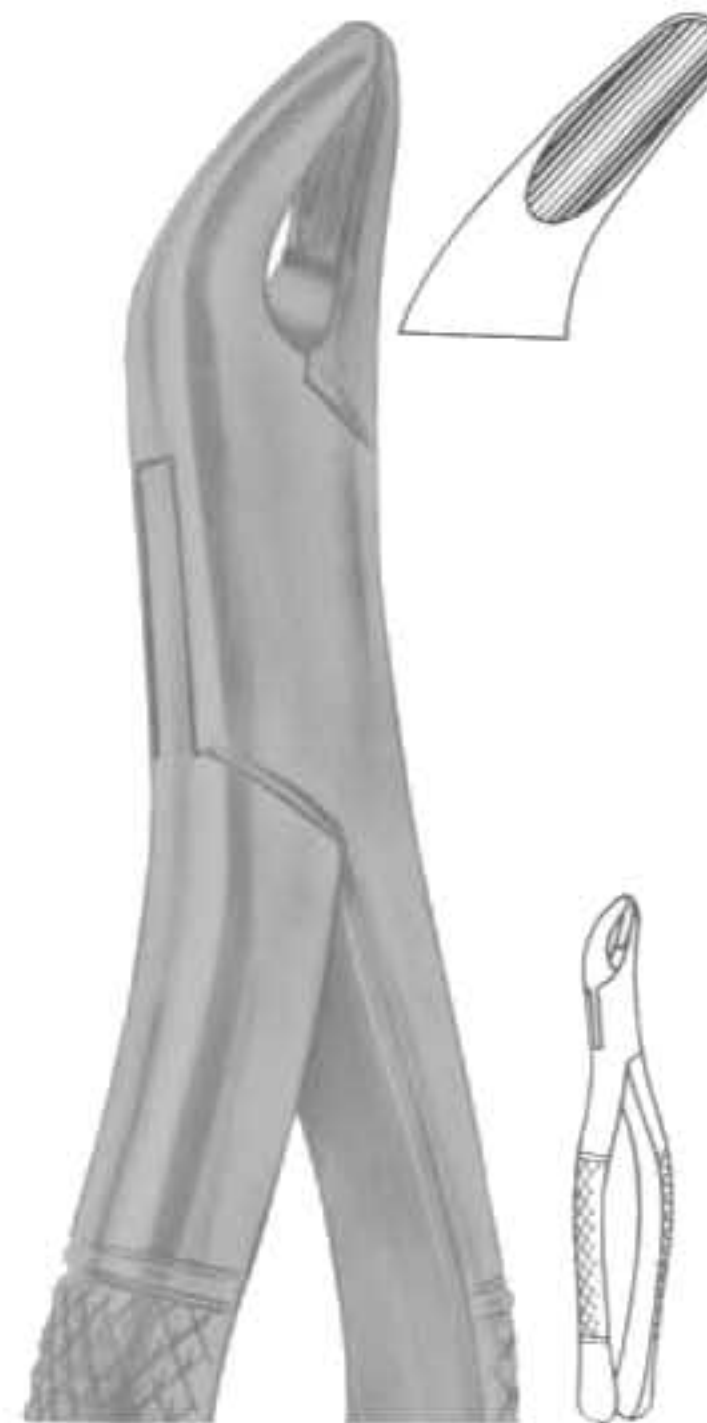

**1256**  
Fig. 62  
incisors, premolars,  
deciduous teeth



**1257**  
Fig. 65  
upper incisors  
and roots



**1258**  
TOMES  
Fig. 69  
upper and lower roots



**1259**  
TOMES  
Fig. 85  
lower canines,  
premolars and molars

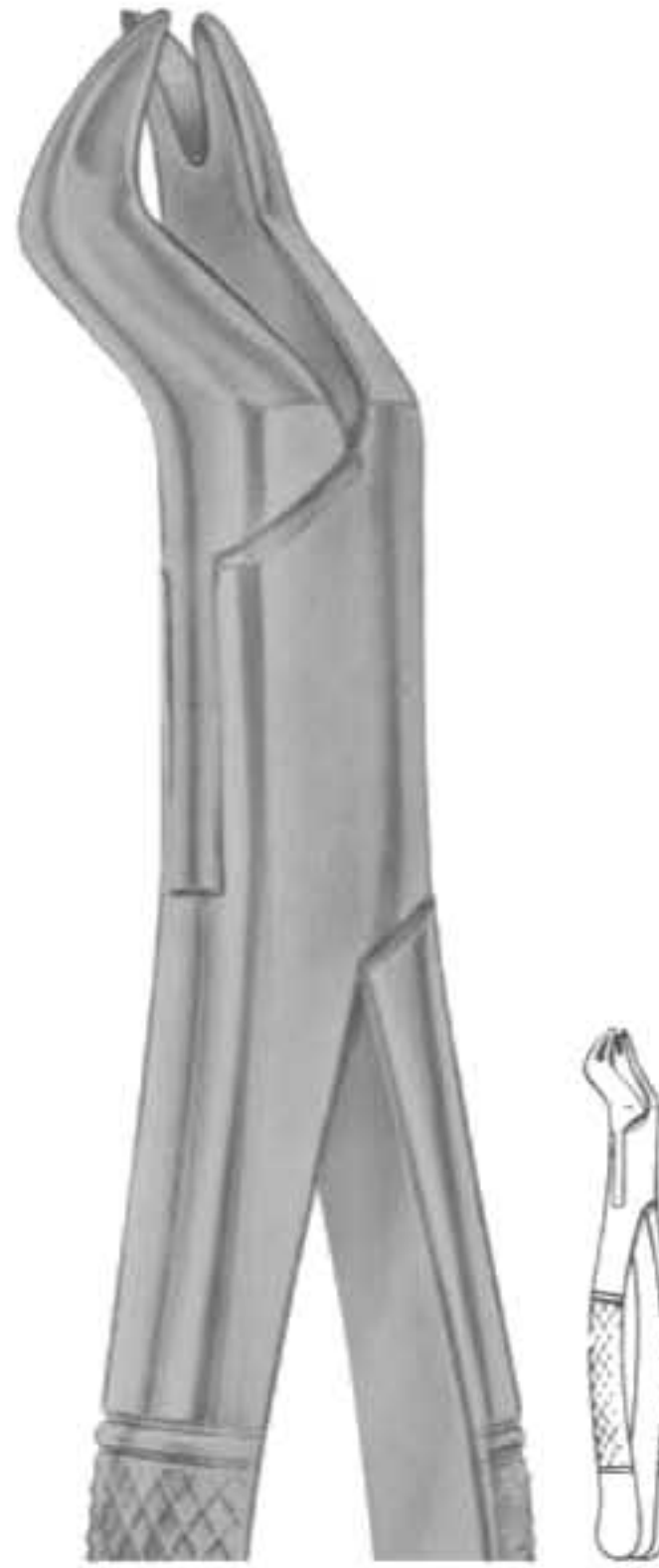

**1260**  
NEVIUS  
Fig. 88R  
upper molars right

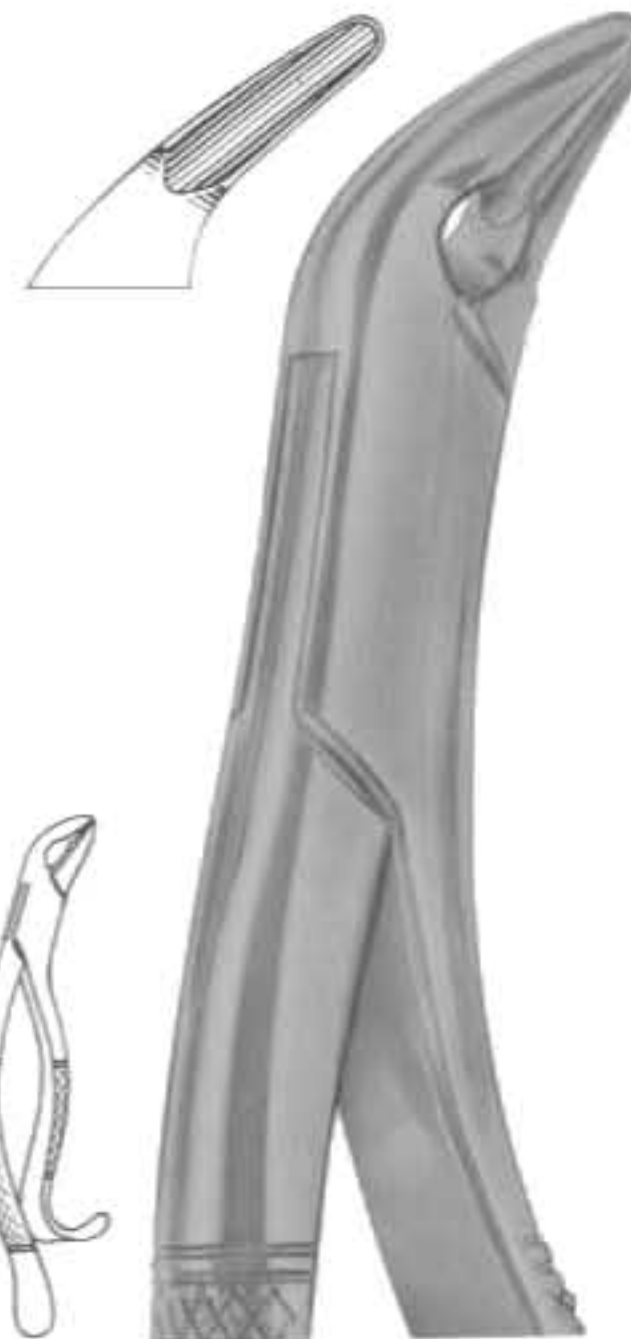

**1261**  
THOMAS  
Fig. 85A  
lower canines,  
premolars and molars



**1262**  
NEVIUS  
Fig. 88L  
upper molars left



**1263**  
KELLS  
Fig. 99A  
upper incisors,  
canines, premolars

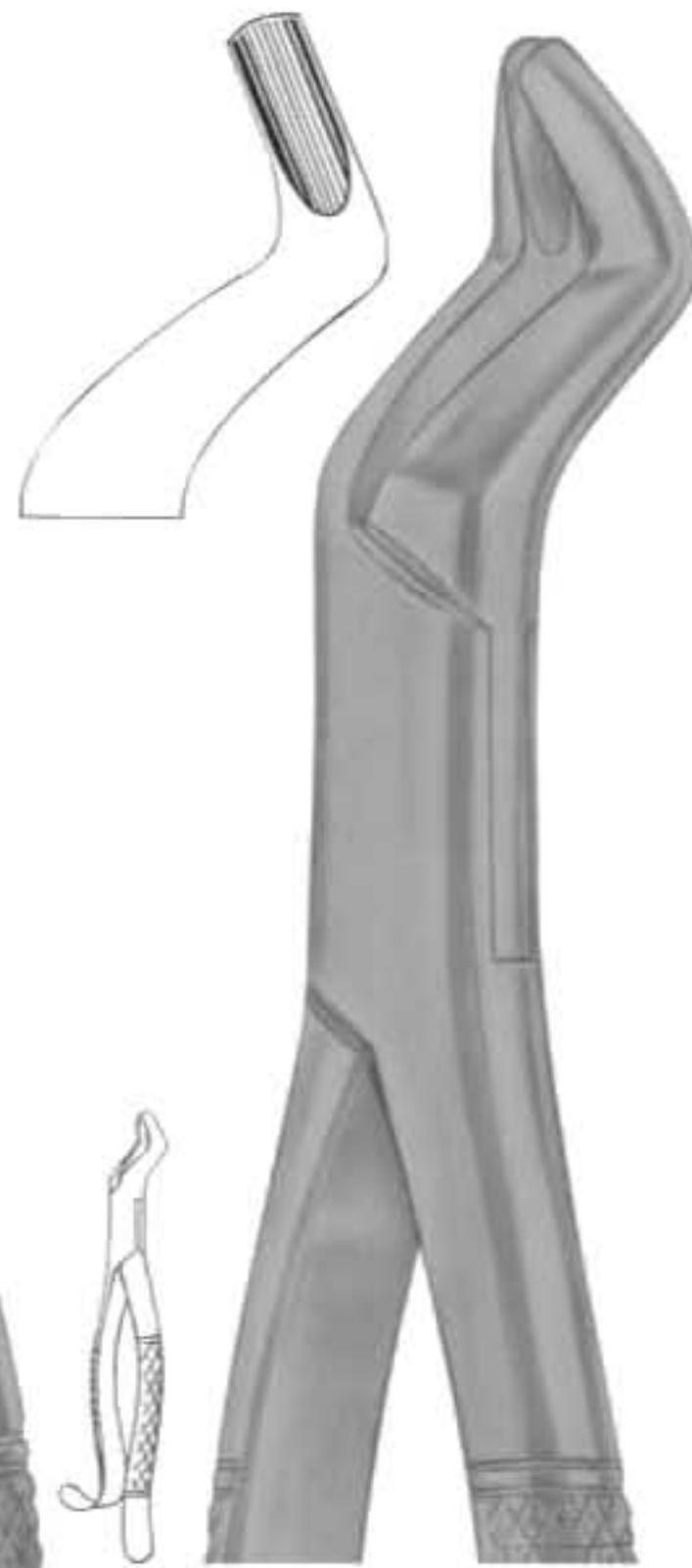

**1264**  
Fig. 104  
upper third molars



**1266**  
HULL  
Fig. 101  
deciduous teeth



**1267**  
Fig. 103  
lower incisors,  
premolars



**1265**  
KELLS  
Fig. 99C  
upper incisors,  
canines, premolars





**1268**  
CRYER  
Fig. 150  
lower incisors,  
premolars, roots



**1269**  
CRYER  
Fig. 150A  
upper incisors,  
premolars, roots



**1271**  
CRYER  
Fig. 151  
lower incisors,  
premolars, roots



**1272**  
CRYER  
Fig. 151A  
lower incisors,  
premolars, roots

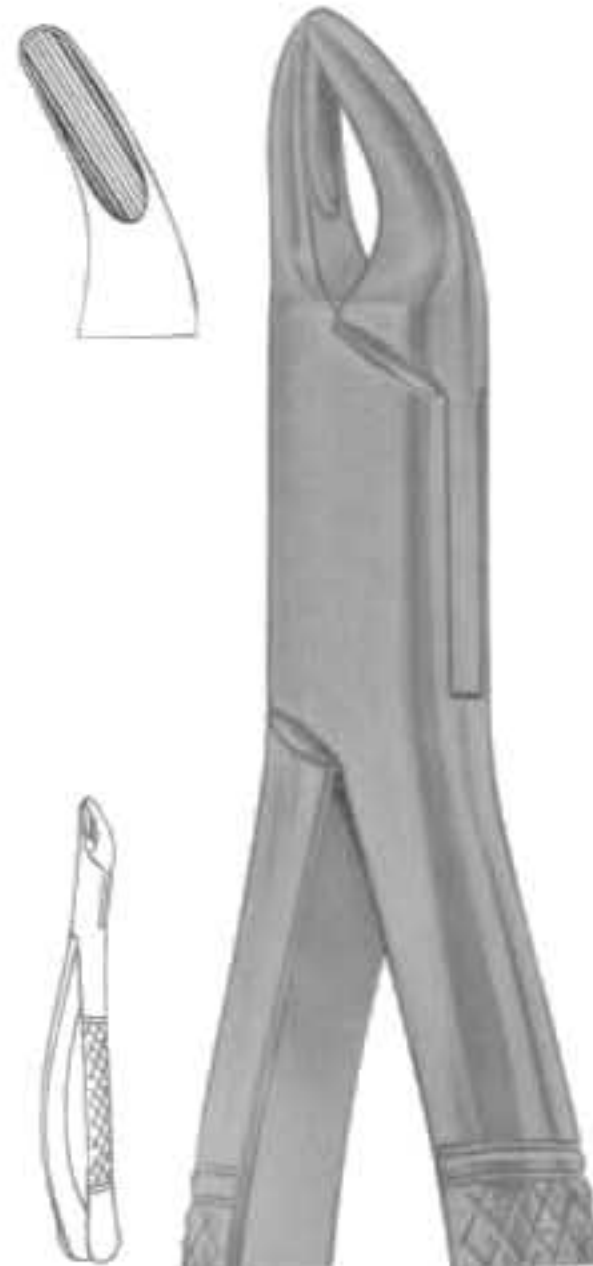

**1270**  
CRYER  
Fig. 150S  
upper teeth for children

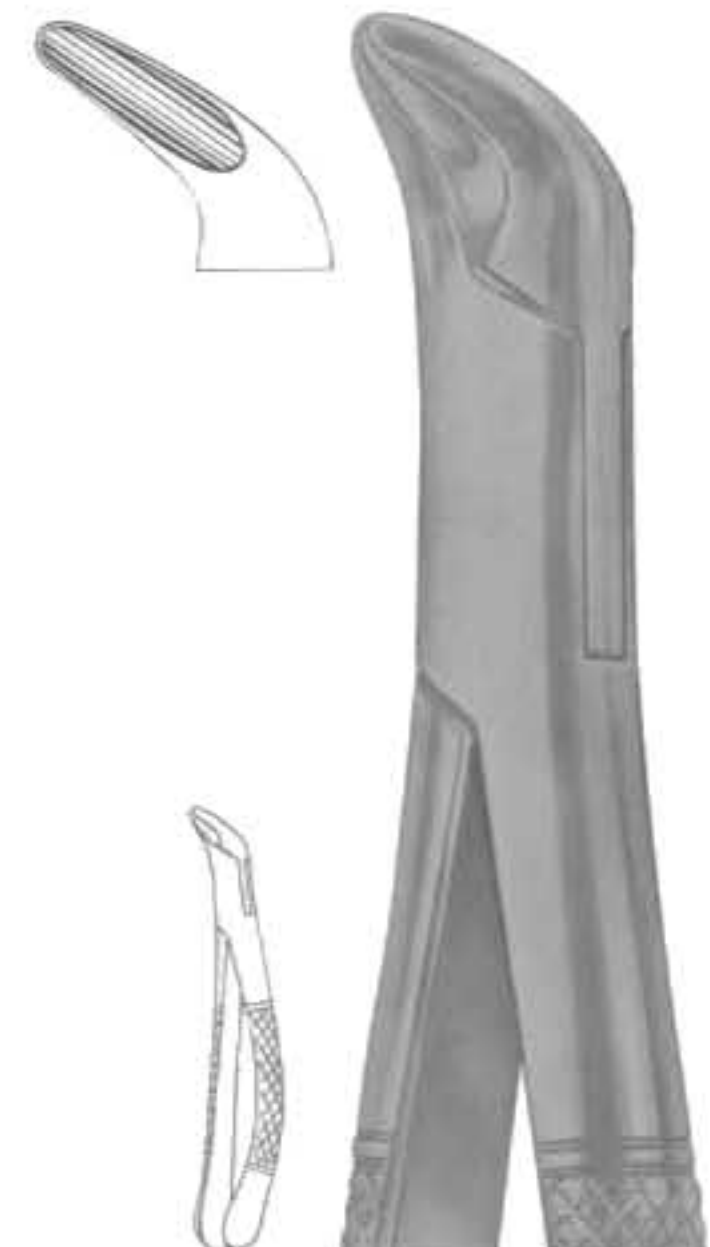

**1273**  
CRYER  
Fig. 151S  
lower teeth  
for children



**1274**  
Fig. 203  
lower incisors  
and roots

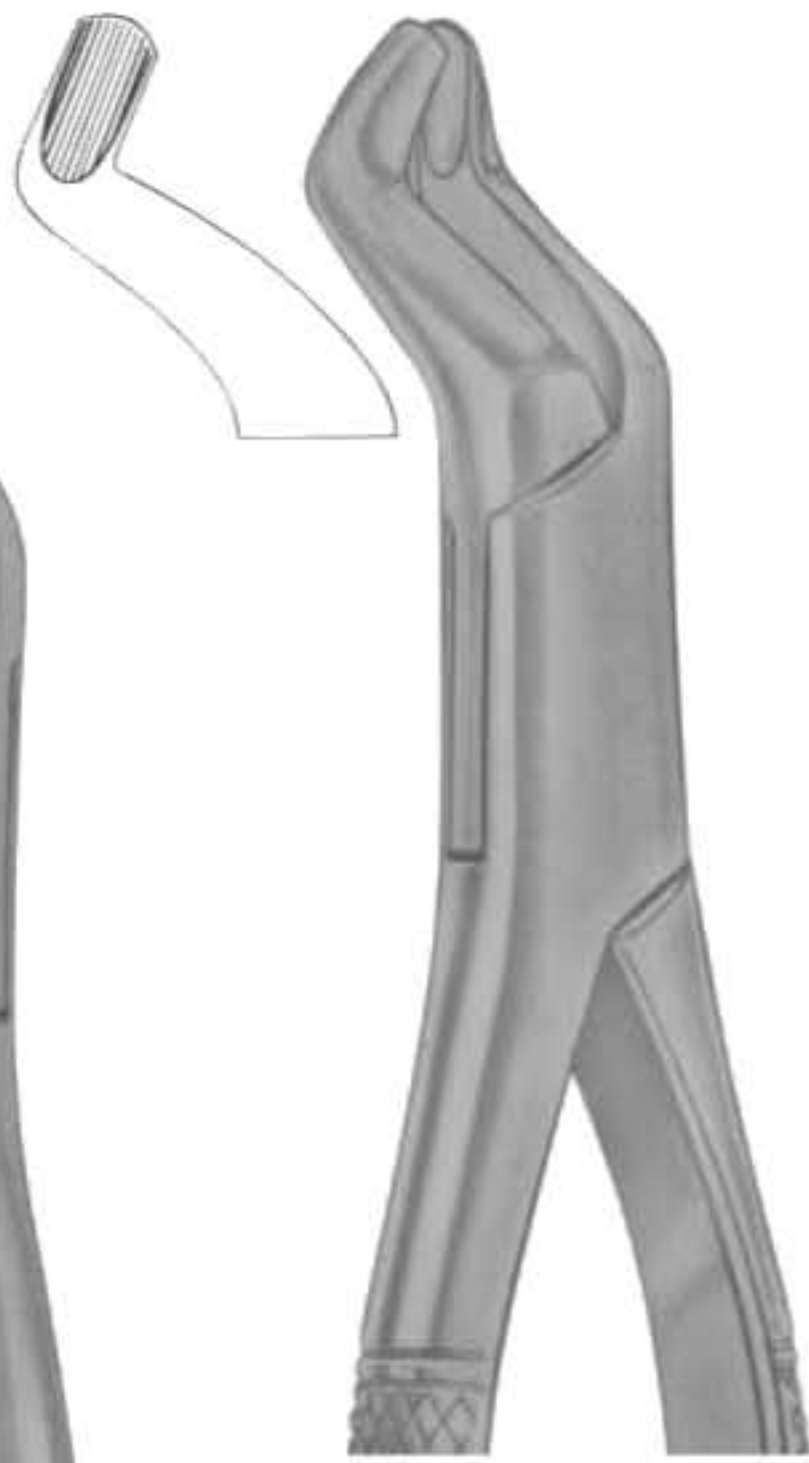

**1275**  
Fig. 210S  
upper third molars

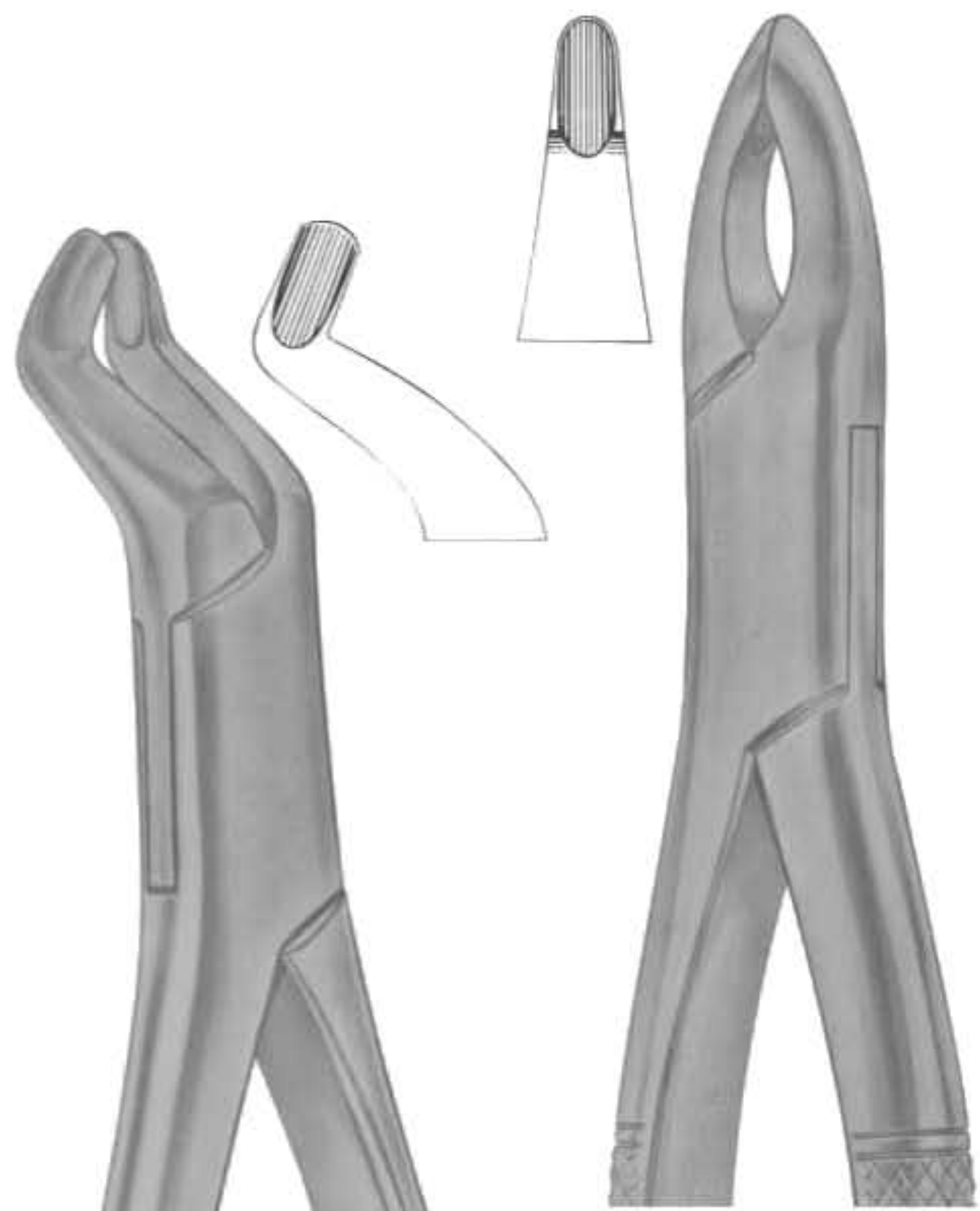

**1278**  
Fig. 213  
upper centrals and canines



**1276**  
Fig. 201  
upper incisors,  
canines, premolars



**1277**  
Fig. 210H  
upper third molars



**1279**  
Fig. 217  
lower molars

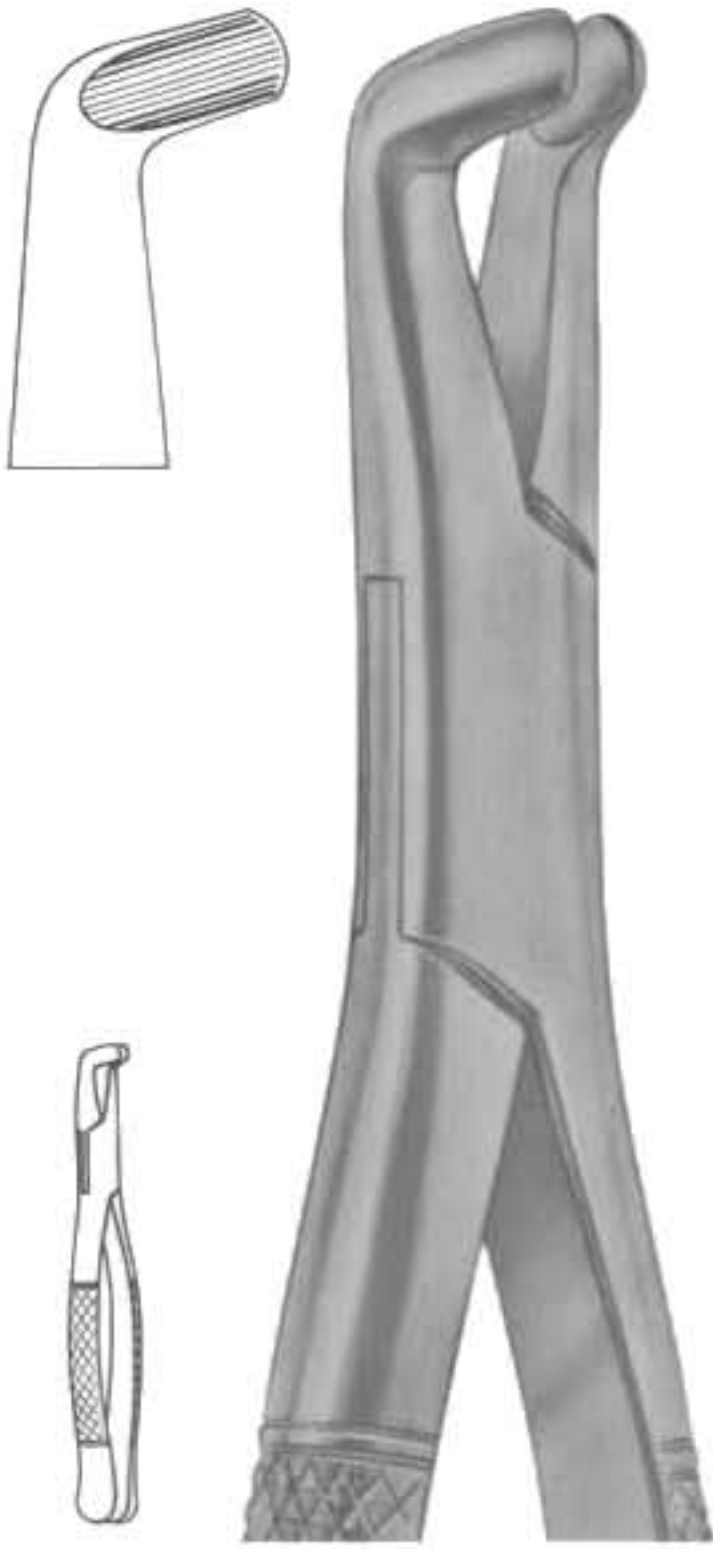

**1280**  
Fig. 222  
lower third molars



**1282**  
Fig. 286  
Swing lower molars



**1283**  
Fig. 288  
lower canines  
and premolars

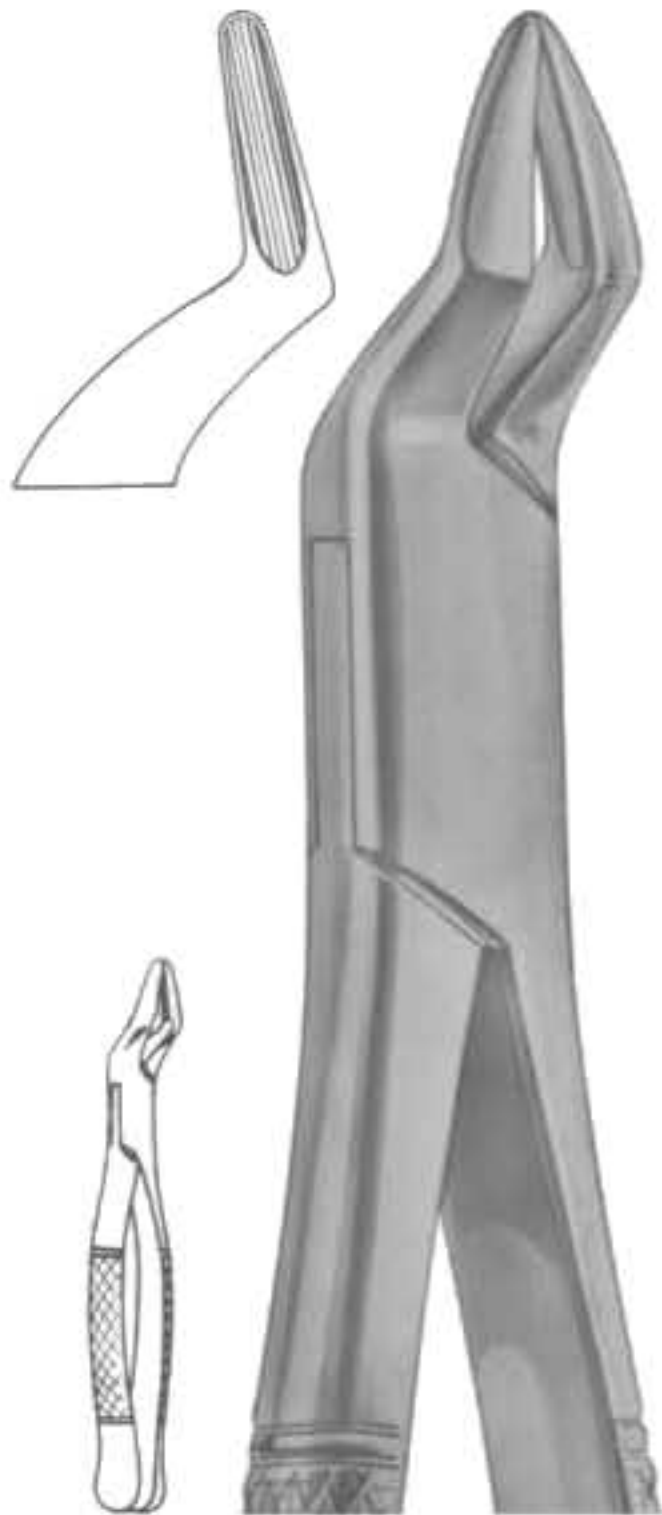

**1281**  
Fig. 286  
upper incisors and roots





**1284**  
COHEN  
Fig. 310  
universal forceps

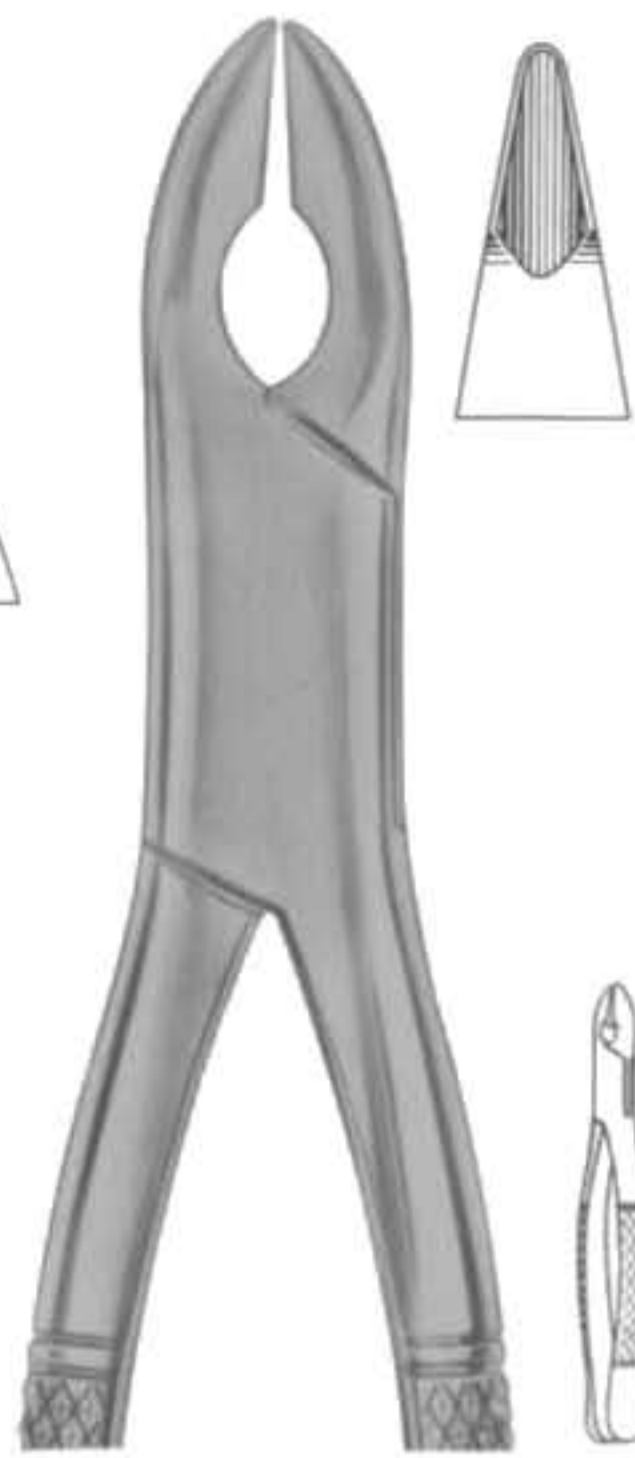

**1285**  
NEVIUS  
Fig. 320/10S  
upper canines

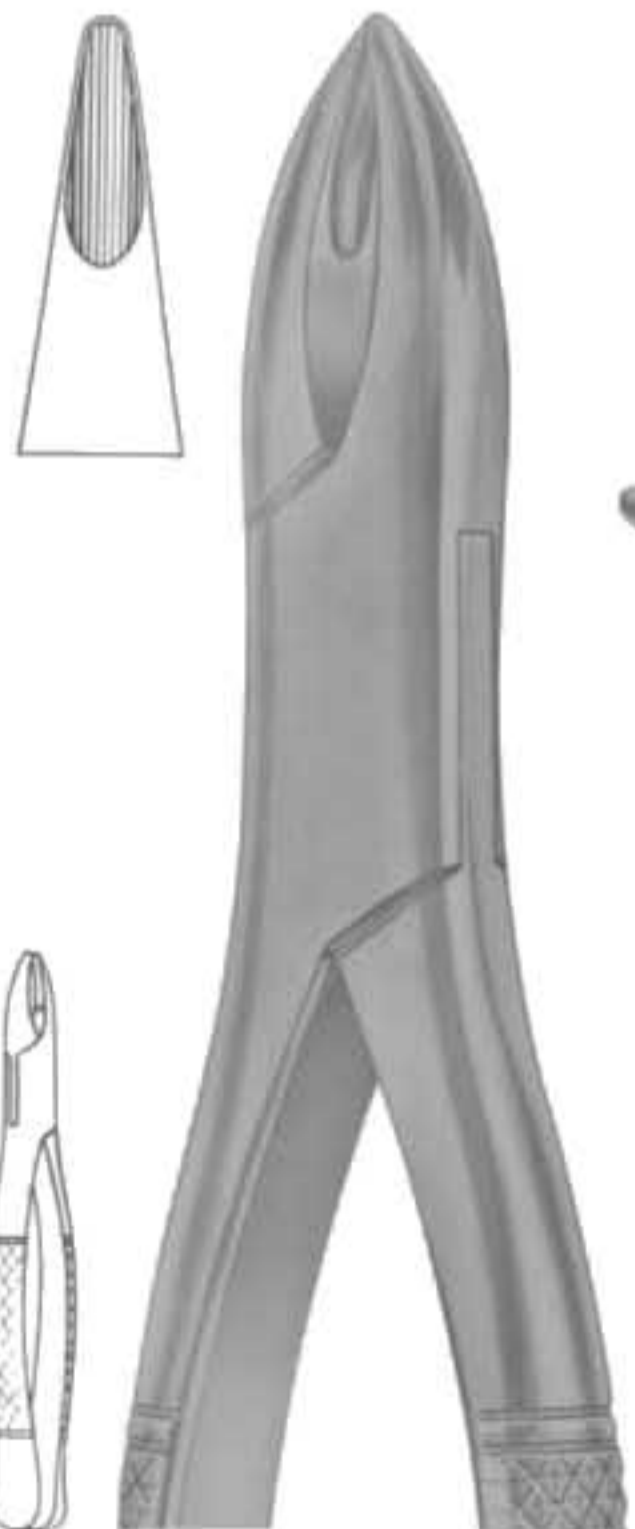

**1286**  
HENAHAN  
Fig. 315/1A  
upper incisors

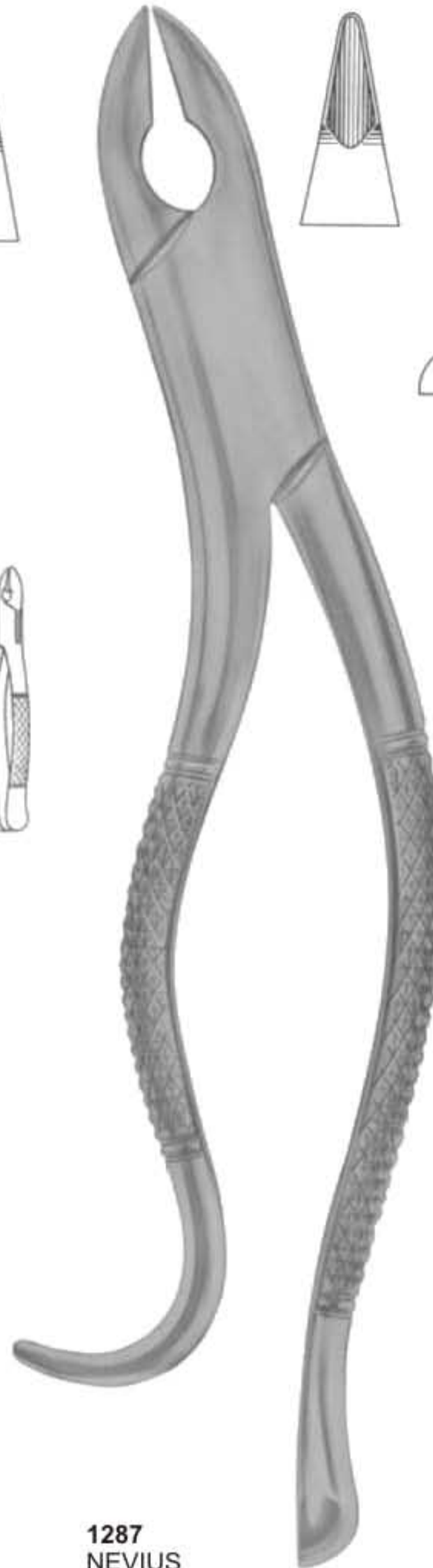

**1287**  
NEVIUS  
Fig. 325/10H  
upper canines

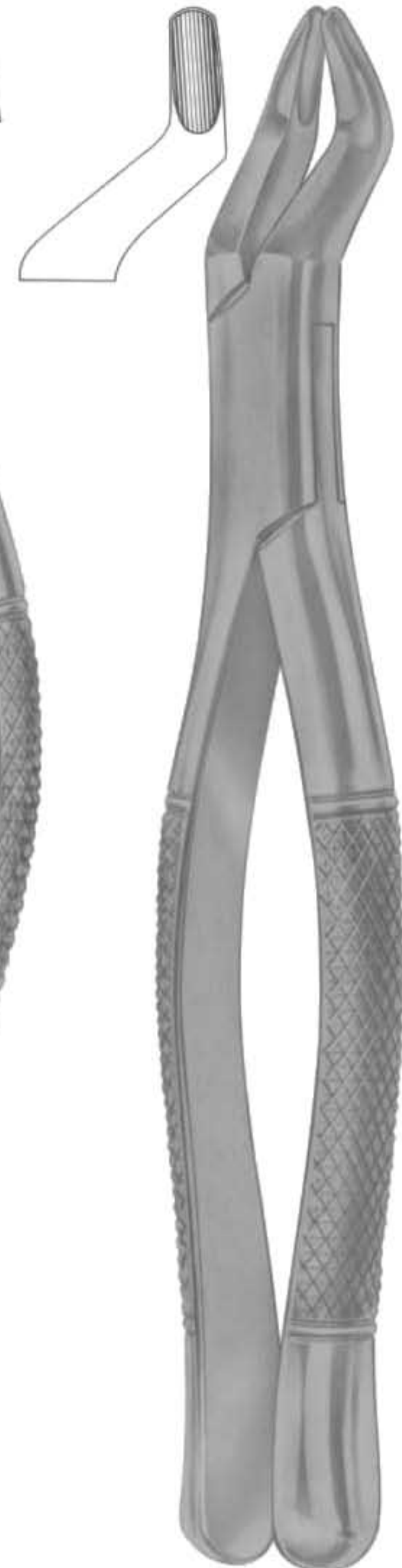

**1288**  
STANDARD  
Fig. 330/4  
upper third molars



**1289**  
WOODWARD  
Fig. 335/FH  
lower molars

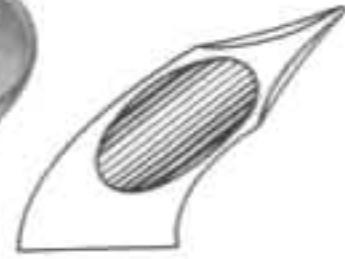

**1291**  
WOODWARD  
Fig. 335/FS  
lower molars

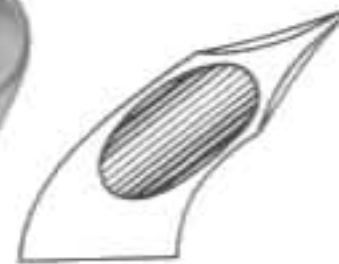

**1290**  
Fig. 340/89  
upper molars right

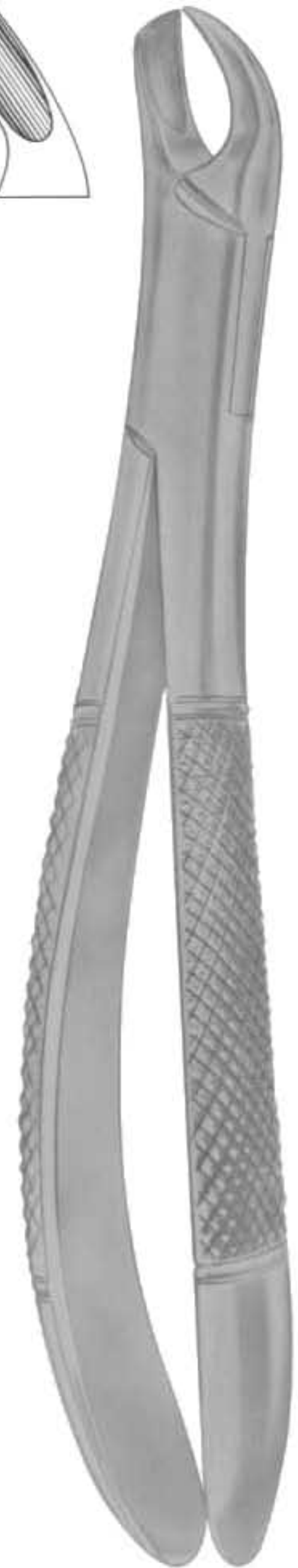

**1292**  
Fig. 345/90  
upper molars left



**1293**  
Fig. 350/23S  
lower molars



**1294**  
Fig. 355/23SK  
lower molars



**1295**  
Forcep Fig. 301



**1295-A**  
Forcep Fig. 300



**1296**  
Fig. 360/17SK  
lower molars



**1297**  
Fig. 365/150SK  
upper anteriors  
and roots



**1298**  
Fig. 370/151SK  
lower anteriors  
and roots

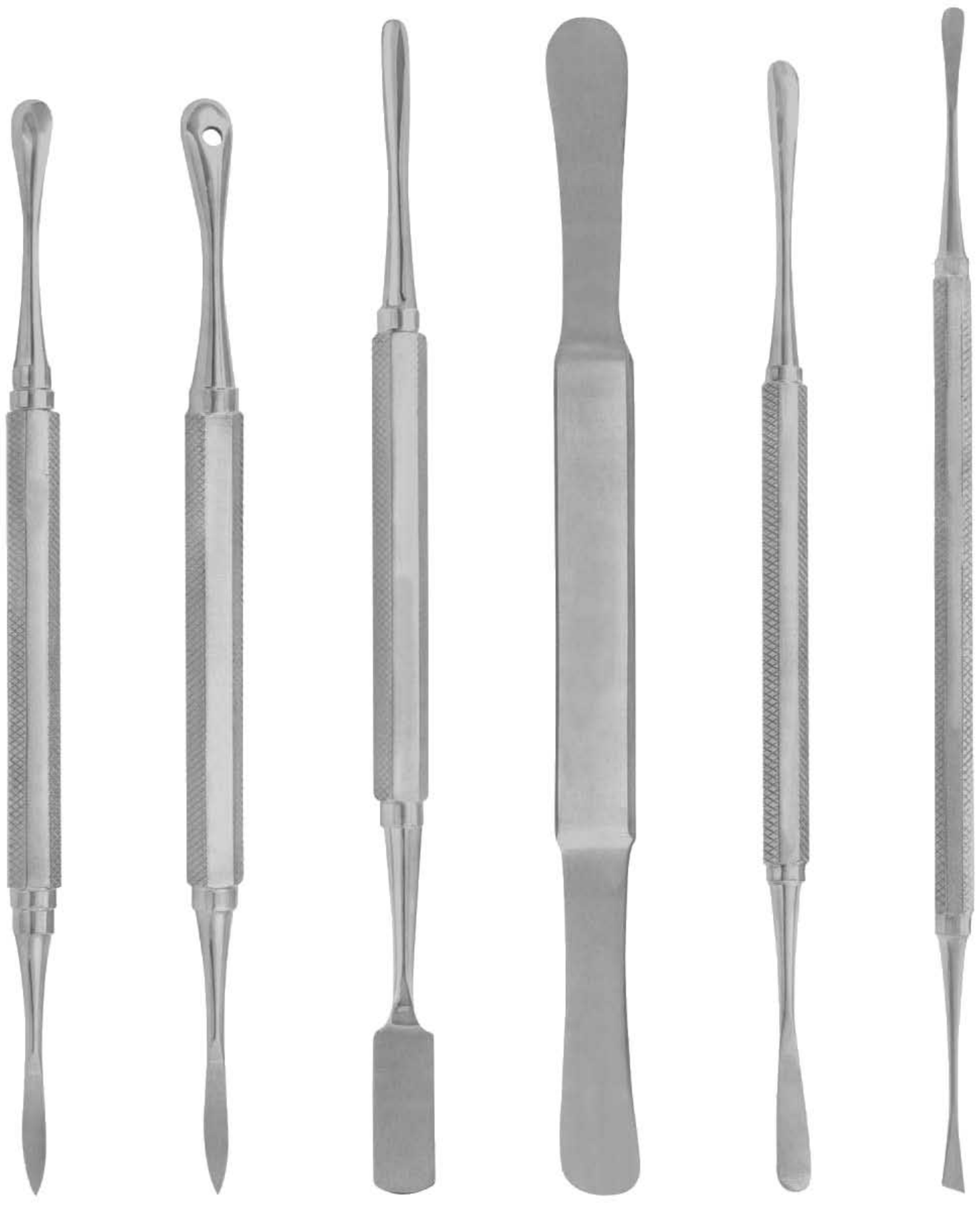

**1299**  
Molt 9

**1300**  
Allen 9A

**1301**  
Prichard

**1302**  
Seldin

**1303**  
Goldman- Fox 14

**1304**  
West  
Dell W2



Heidbrink Root - Tip Picks

Root Tip



1305  
DEL 78



1306  
DEL 79



1307  
DEL 80



1308  
DEL H1



1309  
DEL H2



1310  
DEL H3



1311  
DEL H2-3



1312  
POTT  
6X



1313  
POTT  
7X





**1314**  
BUSER



**1315**  
OHI 10



**1316**  
HOWARD 9H



**1317**  
FREER



**1318**  
FREER 15



**1319**  
FREER 16



lower jaw, left side

lower jaw, right side



**1320**  
BEIN  
Fig. 4



**1331**



**1332**

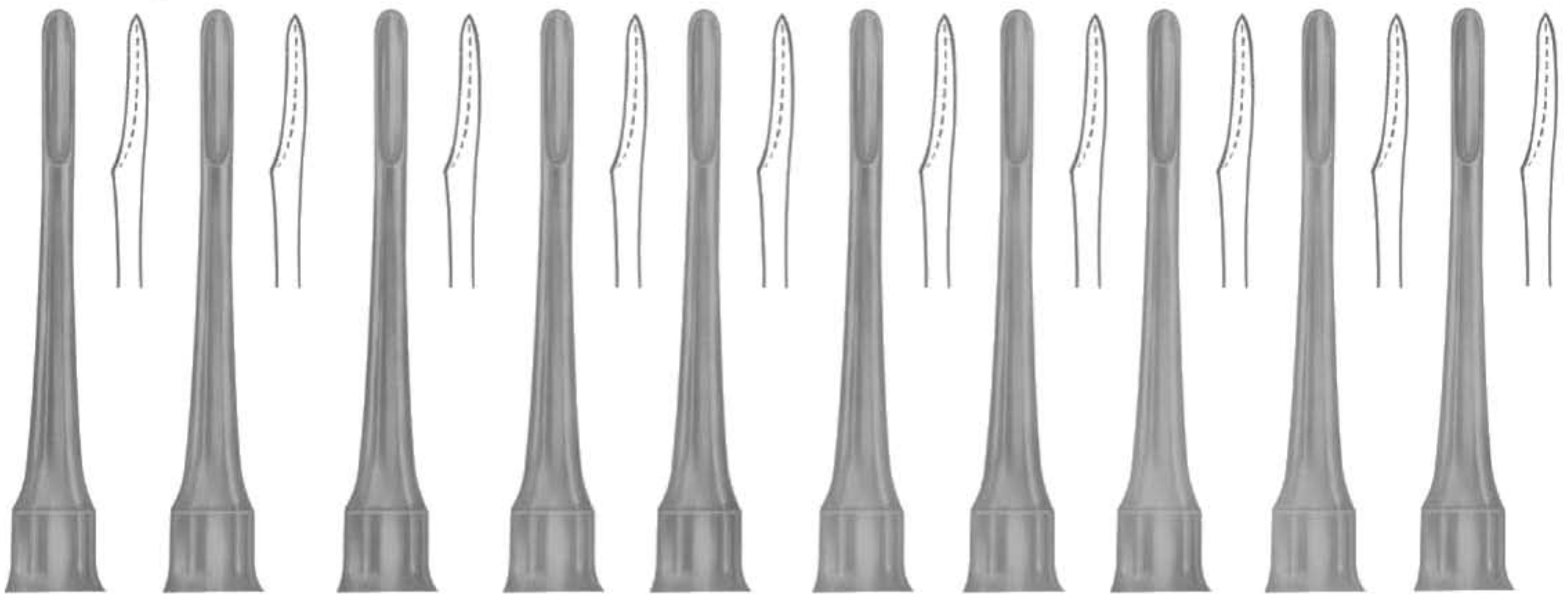

**1321**  
BEIN  
1.0 mm

**1322**  
BEIN  
1.5 mm

**1323**  
BEIN  
2.0 mm

**1324**  
BEIN  
2.5 mm

**1325**  
BEIN  
3.0 mm

**1326**  
BEIN  
3.5 mm

**1327**  
BEIN  
4.0 mm

**1328**  
BEIN  
4.5 mm

**1329**  
BEIN  
5.0 mm

**1330**  
BEIN  
5.5 mm





**1333**  
BEIN

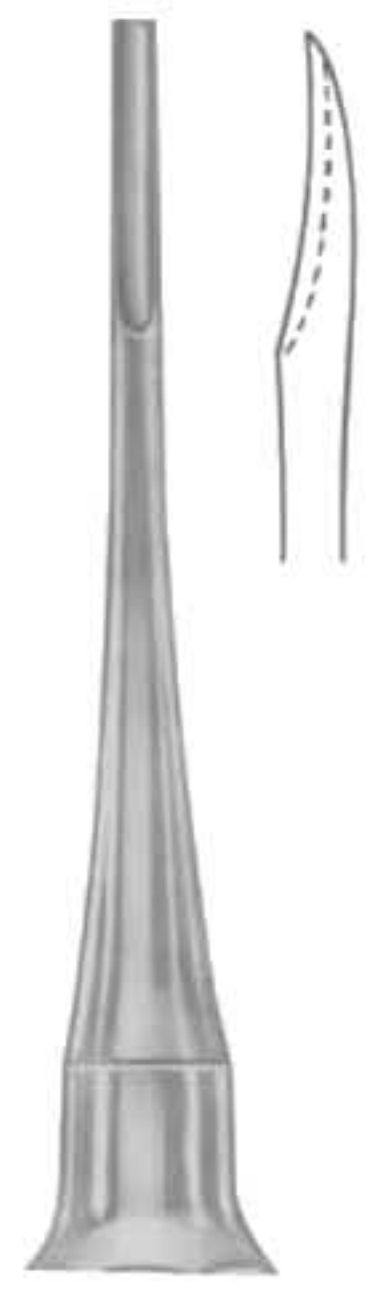

**1334**  
BEIN  
Fig. 1



**1335**  
BEIN  
Fig. 2

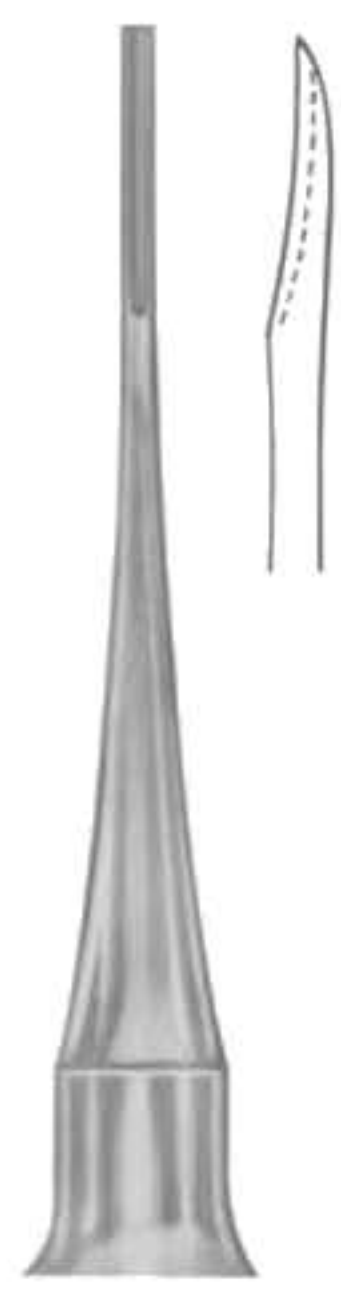

**1336**  
BEIN  
Fig. 0



**1337**  
BEIN  
Fig. 3



**1338**  
BEIN  
Fig. 4



**1339**  
BEIN  
Fig. 5



**1340**  
BEIN  
Fig. 6





**1341**  
CRYER  
Fig. 3



**1342**  
CRYER  
Fig. 4



**1343**  
CRYER  
Fig. 12



**1344**  
CRYER  
Fig. 27



**1345**  
CRYER  
Fig. 28



**1346**  
CRYER  
Fig. 27S



**1347**  
CRYER  
Fig. 28S



**1348**  
SELDIN  
Fig. 2



**1349**  
SELDIN  
Fig. 3



**1350**  
SELDIN  
Fig. 4L



**1351**  
SELDIN  
Fig. 4R



**1352**  
SELDIN  
Fig. 1L



**1353**  
SELDIN  
Fig. 1R



1354



1355

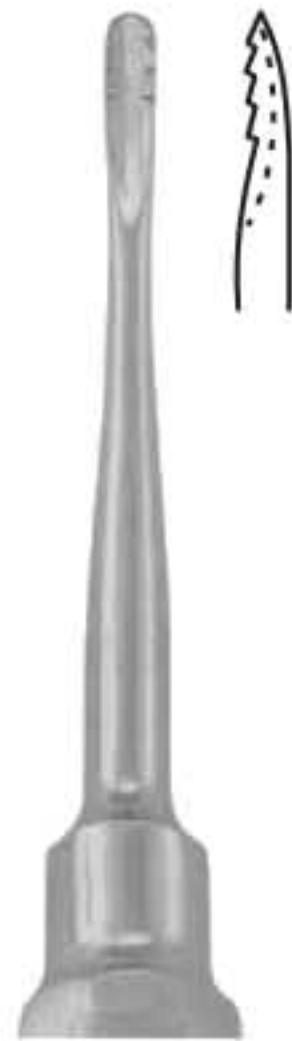

1356



1357

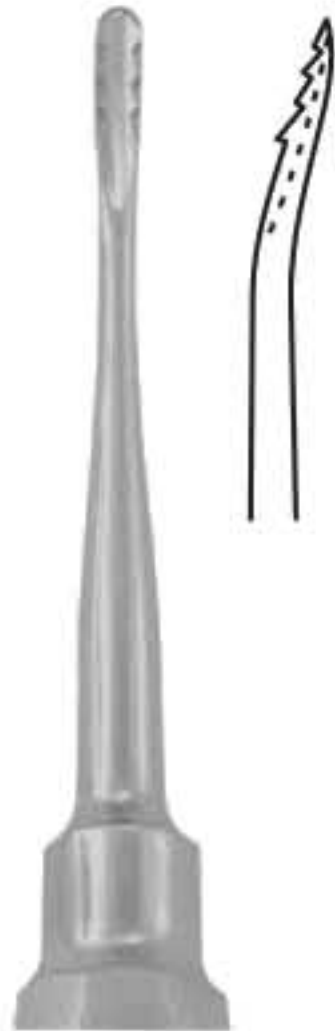

1358

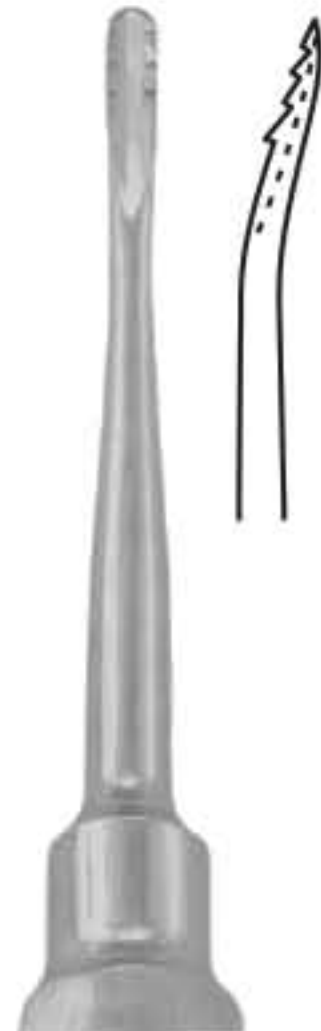

1359

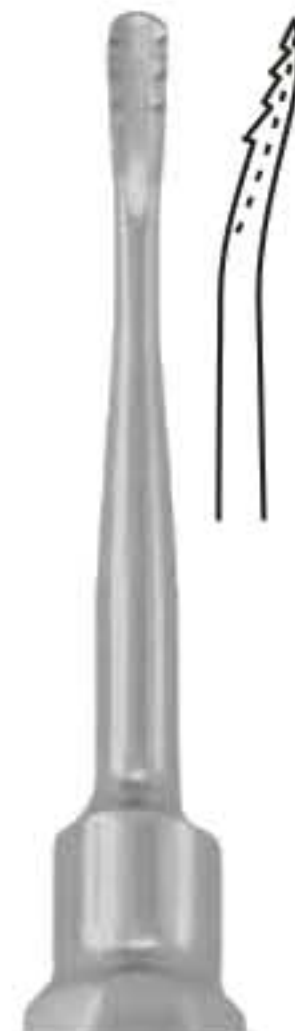

1360

## Root Screws



1362  
Morrison  
2.0 mm



1363  
Morrison  
2.5 mm



1364  
Morrison  
3.0 mm

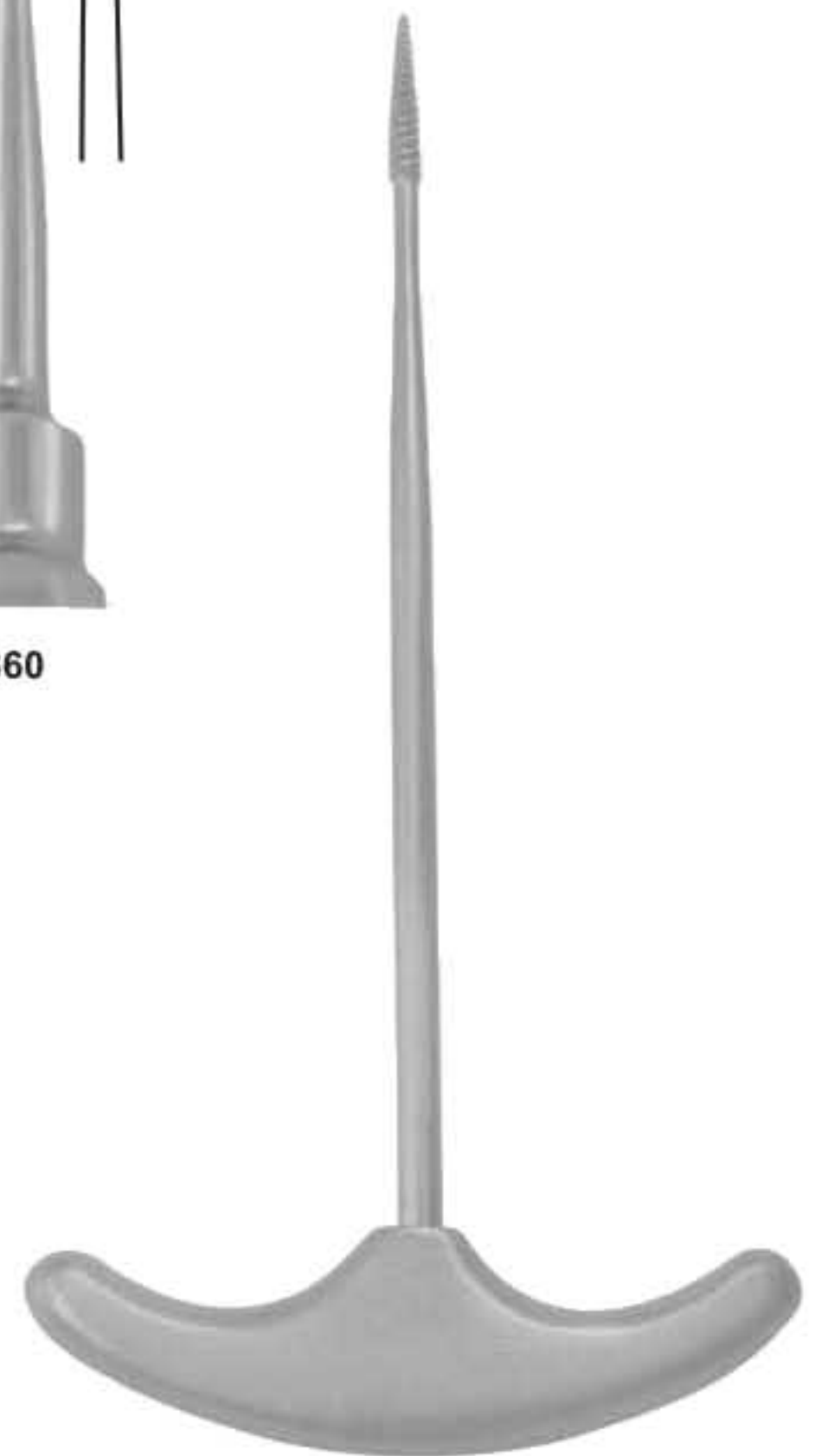

1361  
Morrison  
3.5 mm



**1365**  
IS-APICAL



**1366**  
APICAL  
2 mm  
Fig. 1



**1367**  
APICAL  
3 mm  
Fig. 2



**1368**  
APICAL  
4 mm  
Fig. 3



**1369**  
APICAL  
4.5 mm  
Fig. 4



**1370**  
APICAL  
2 mm  
Fig. 5



**1371**  
APICAL  
3 mm  
Fig. 6



**1372**  
APICAL  
4 mm  
Fig. 7



**1373**  
APICAL  
4.5 mm  
Fig. 8



**1374**  
APICAL  
Fig. 9



**1375**  
WINTER  
Fig. 14 L



**1376**  
WINTER  
Fig. 14 R



**1377**  
HEIDBRINK  
Fig. 1



**1378**  
HEIDBRINK  
Fig. 2



**1379**  
FLOHR  
Fig. 1



**1380**  
FLOHR  
Fig. 2



**1381**  
APICAL  
Fig. 1



**1382**  
APICAL  
Fig. 2



**1383**  
IS-CRYER



**1384**  
CRYER  
Fig. 1



**1385**  
CRYER  
Fig. 2



**1386**  
IS-COUPLAND



**1387**  
COUPLAND  
Fig. 1

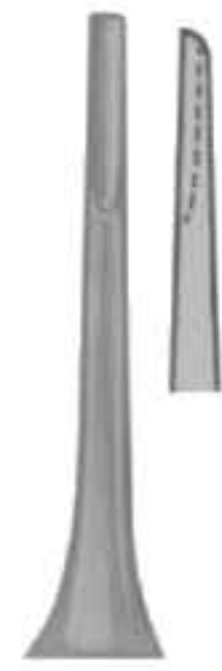

**1388**  
COUPLAND  
Fig. 2



**1389**  
COUPLAND  
Fig. 3



1390  
Fig. 1



1391  
Fig. 2

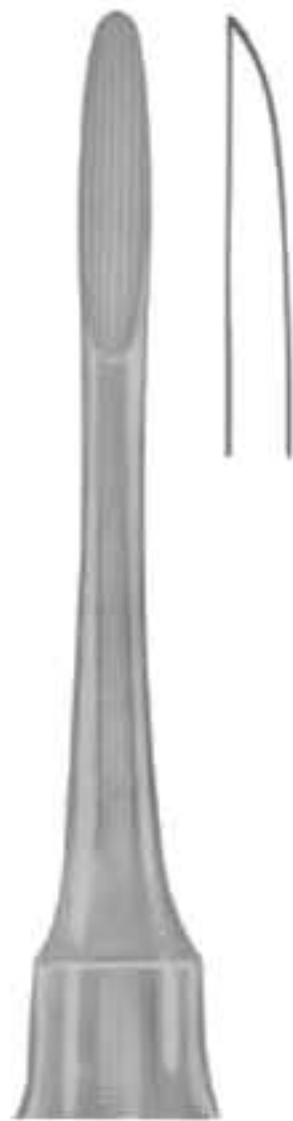

1392  
Fig. 3



1393  
FLOHR  
Fig. 1



1394  
FLOHR  
Fig. 2



1395  
FLOHR  
Fig. 3





**1396**  
KOPP  
Fig. 1



**1397**  
KOPP  
Fig. 2



**1403**  
KOPP  
Fig. 1



**1404**  
KOPP  
Fig. 2



**1396**  
KOPP



**1398**  
KOPP  
Fig. 3



**1399**  
KOPP  
Fig. 4



**1402**  
KOPP



**1405**  
KOPP  
Fig. 3



**1406**  
KOPP  
Fig. 4



**1400**  
KOPP  
Fig. 5



**1401**  
KOPP  
Fig. 6





**1407**  
HYLIN



**1407**  
HYLIN  
Fig. 1



**1408**  
HYLIN  
Fig. 2



**1409**  
BEIN

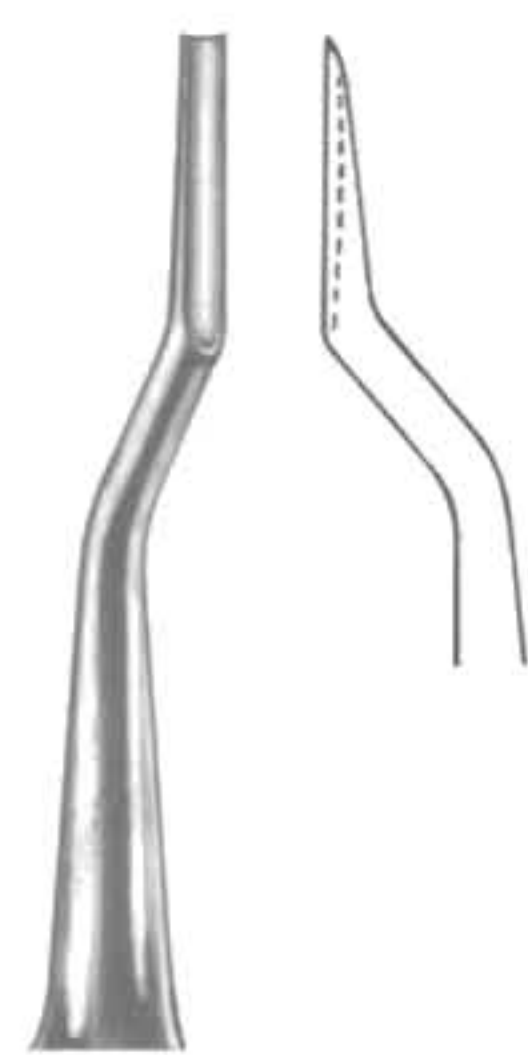

**1409**  
BEIN  
Fig. 1

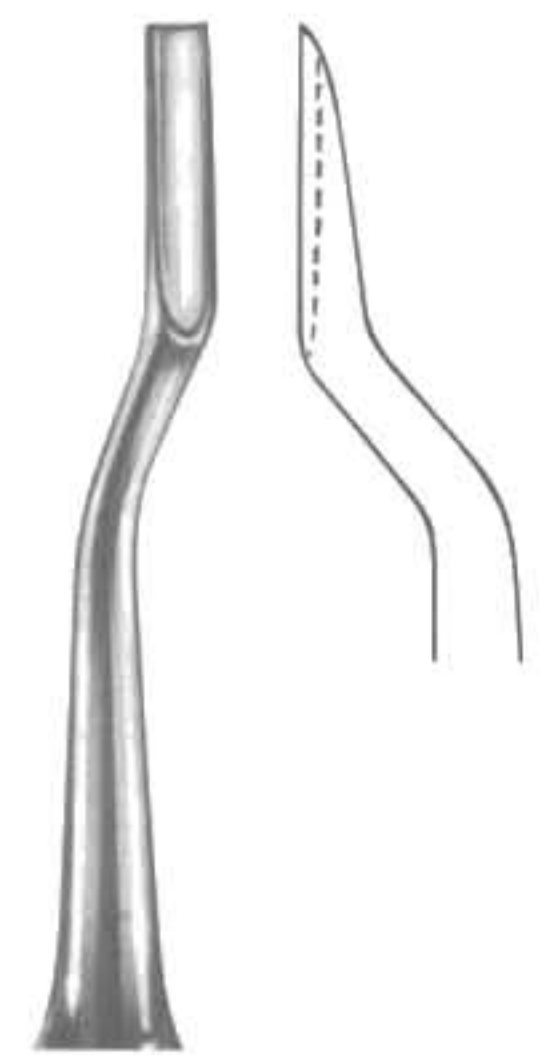

**1410**  
BEIN  
Fig. 2

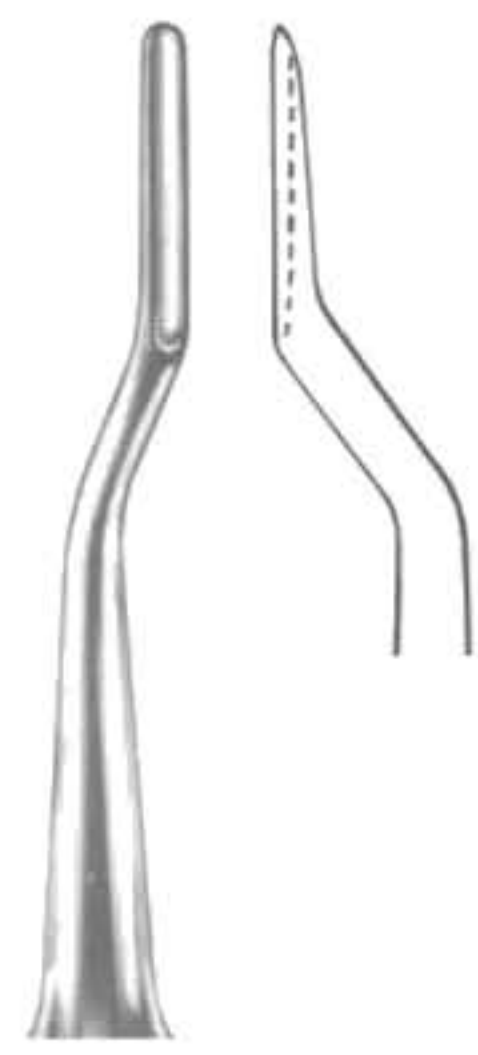

**1411**  
BEIN  
Fig. 3

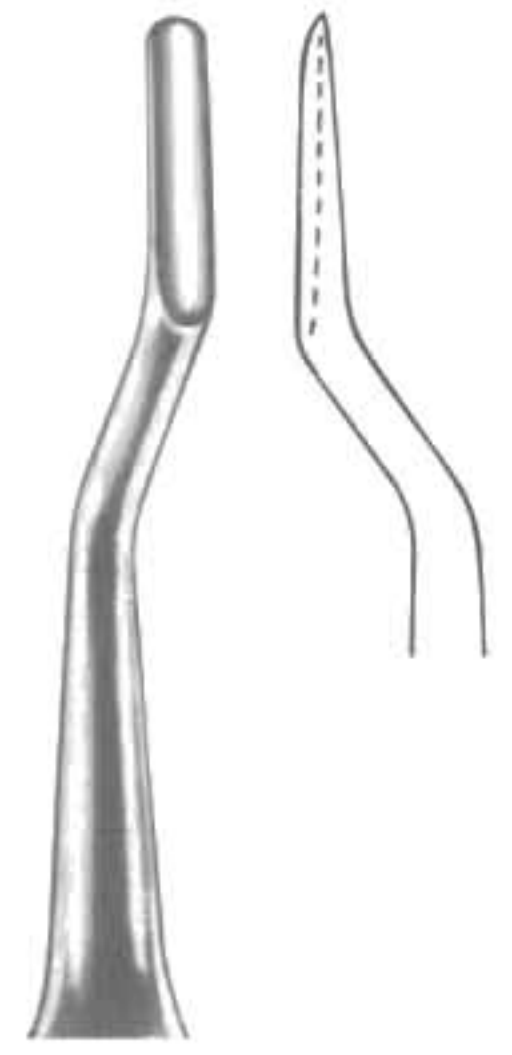

**1412**  
BEIN  
Fig. 4





**1413**  
WARWICK-JAMES  
Fig. 1



**1413**  
Warwick-James  
Fig. 2



**1414**  
Warwick-James  
Fig. 3



**1415**  
London-Hospital  
Fig. 1



**1415**  
London-Hospital  
Fig. 2



**1416**  
London-Hospital  
Fig. 3



**1417**  
OTT



1418  
CHOMPRET  
Fig. 1



1419  
CHOMPRET  
Fig. 2



1420  
CHOMPRET  
Fig. 3



1421  
CHOMPRET  
Fig. 4



1423  
Fig. 1



1422  
Fig. 2

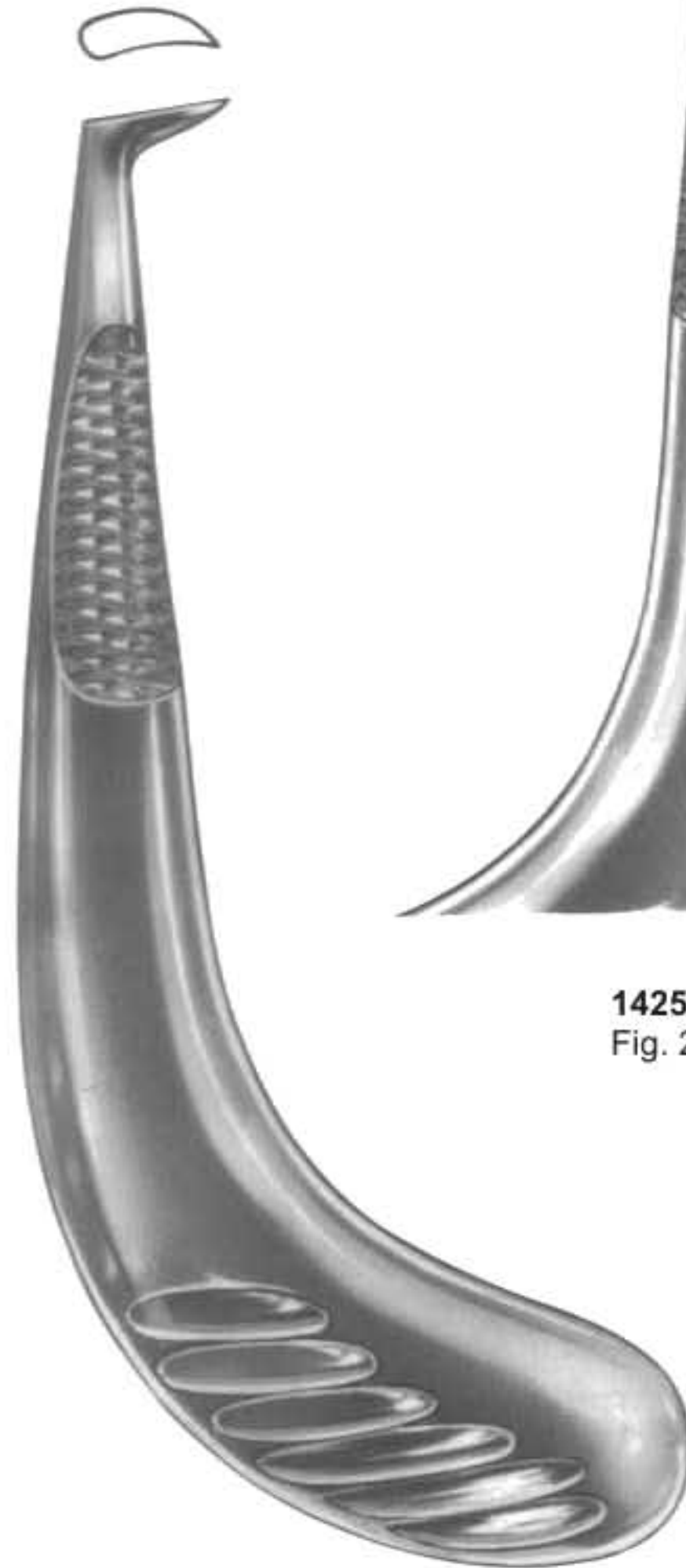

1424  
Fig. 1



1425  
Fig. 2



1426  
APICAL



1427  
IS-Fig. 1



1428  
Fig. 2



1429  
Fig. 3



1430  
HEIDBRINK  
Fig. 1



1431  
HEIDBRINK  
Fig. 2



1432  
HEIDBRINK  
Fig. 3



1438  
MEAD  
MD1



1433  
LECLUSE



1434  
MEAD  
MD-5 A



1435  
MEAD  
MD-6 A



1436  
MEAD  
MD-7 A



1437  
MEAD  
MD-8



**1439**  
WINTER  
Fig. 1L



**1440**  
WINTER  
Fig. 1R



**1441**  
WINTER  
Fig. 2L



**1442**  
WINTER  
Fig. 2R

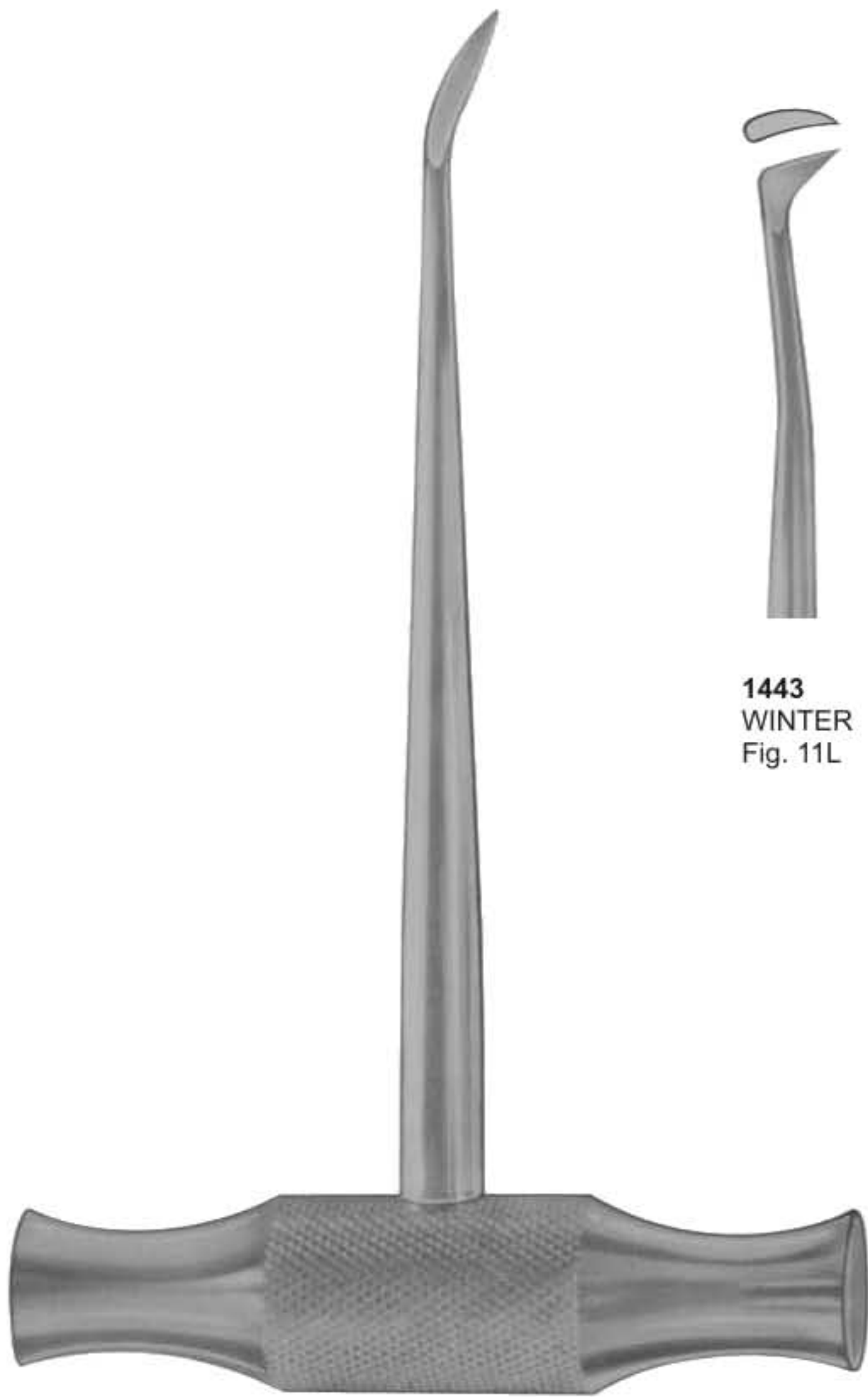

**1439**  
WINTER



**1443**  
WINTER  
Fig. 11L



**1444**  
WINTER  
Fig. 11R



**1445**  
WINTER  
Fig. 12L



**1446**  
WINTER  
Fig. 12R



**1447**  
WINTER  
Fig. 14L



**1448**  
WINTER  
Fig. 14R



1449  
BARRY  
Fig. 1



1450  
BARRY  
Fig. 2



1451  
BARRY  
Fig. 3



1452  
BARRY  
Fig. 4



1449  
BARRY



1453  
BARRY  
Fig. 11



1454  
BARRY  
Fig. 12



1455  
BARRY  
Fig. 17



1456  
BARRY  
Fig. 18



**1458**  
CRYER  
Fig. 26



**1459**  
SELDIN  
Fig. 27



**1460**  
CRYER  
Fig. 28



**1461**  
CRYER  
Fig. 29



**1462**  
HEIDBRINK  
Fig. 22



**1463**  
HEIDBRINK  
Fig. 23



**1457**





**1465**  
KOPP  
Fig. 31



**1466**  
KOPP  
Fig. 32



**1467**  
KOPP  
Fig. 33



**1468**  
KOPP  
Fig. 34



**1469**  
KOPP  
Fig. 35



**1470**  
KOPP  
Fig. 44

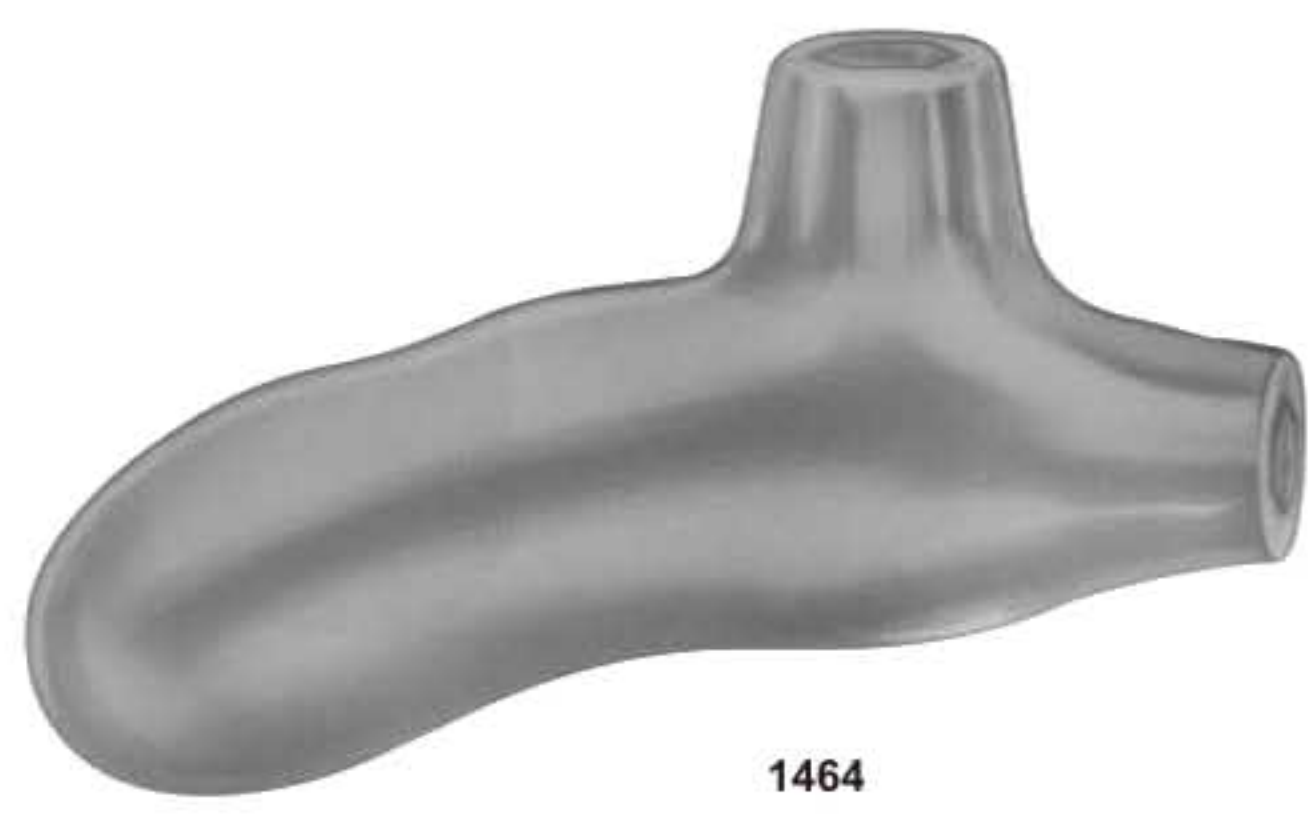

**1464**





1472  
HEIDBRINK  
Fig. 10



1473  
WINTER  
Fig. 11



1474  
WINTER  
Fig. 12



1475  
BARRY  
Fig. 17



1476  
BARRY  
Fig. 18



1477  
BARRY  
Fig. 20



1471

Root Elevators according to Dr. Sader,  
with interchangeable working tips

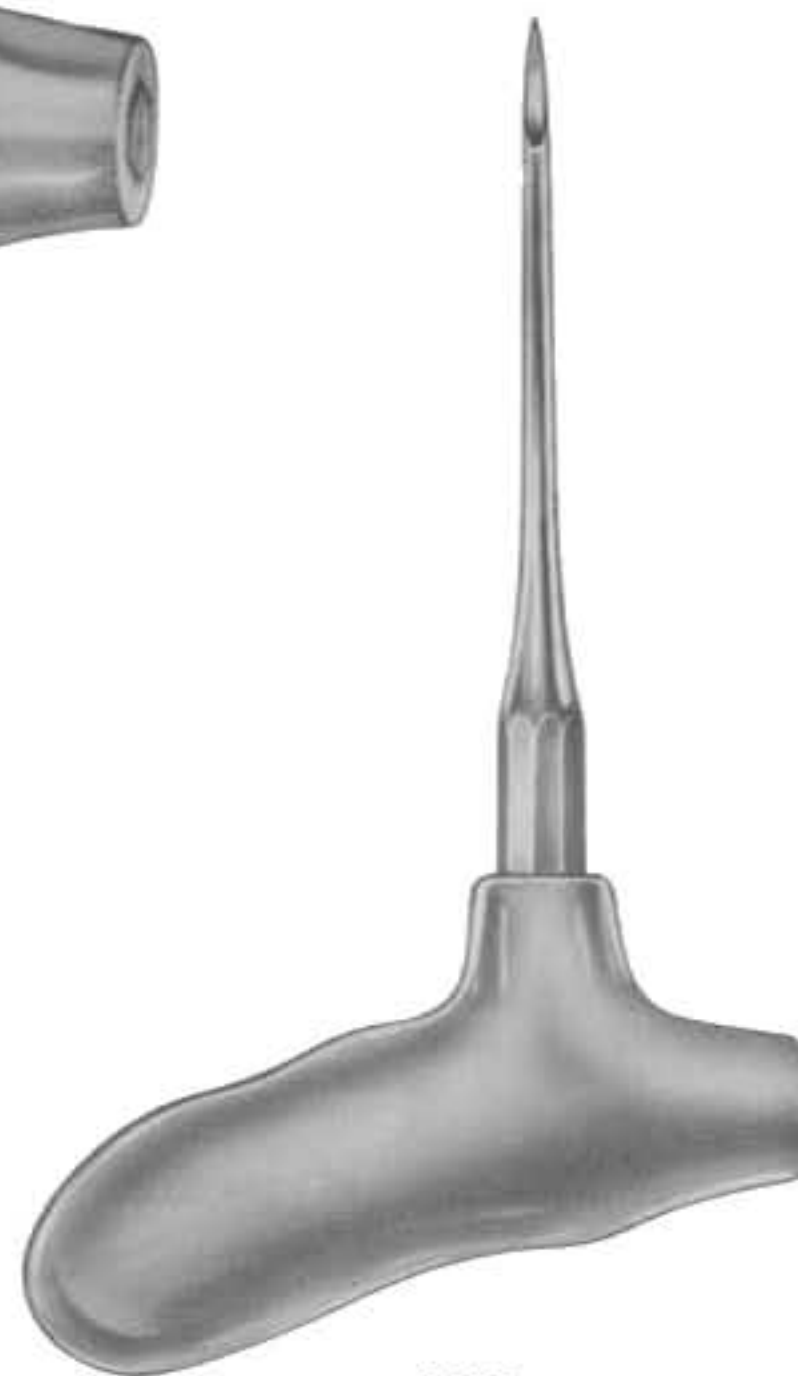

1478



1479



1480

1481  
Root Elevator, Plastic Handle, Set of 10 Pcs

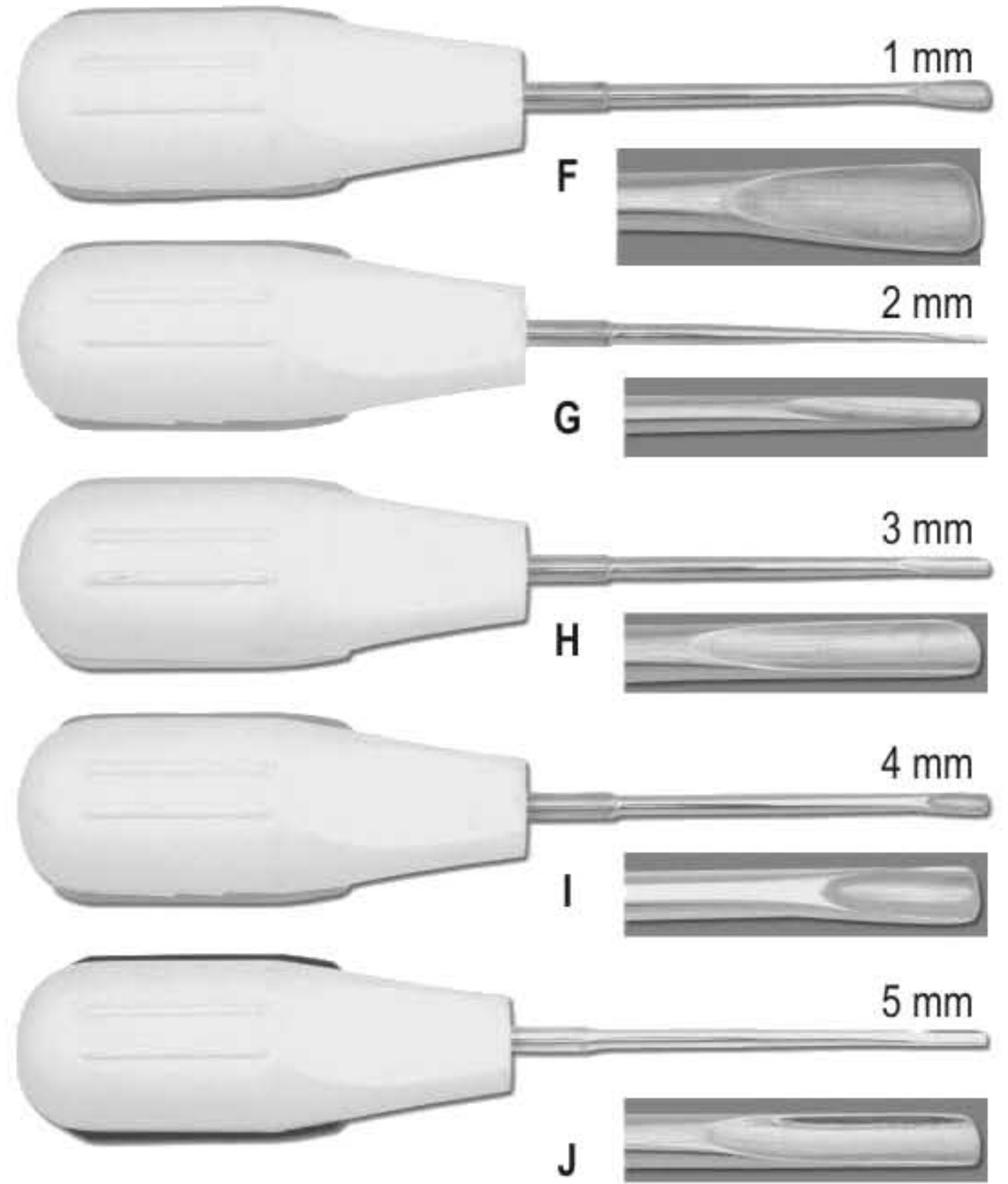
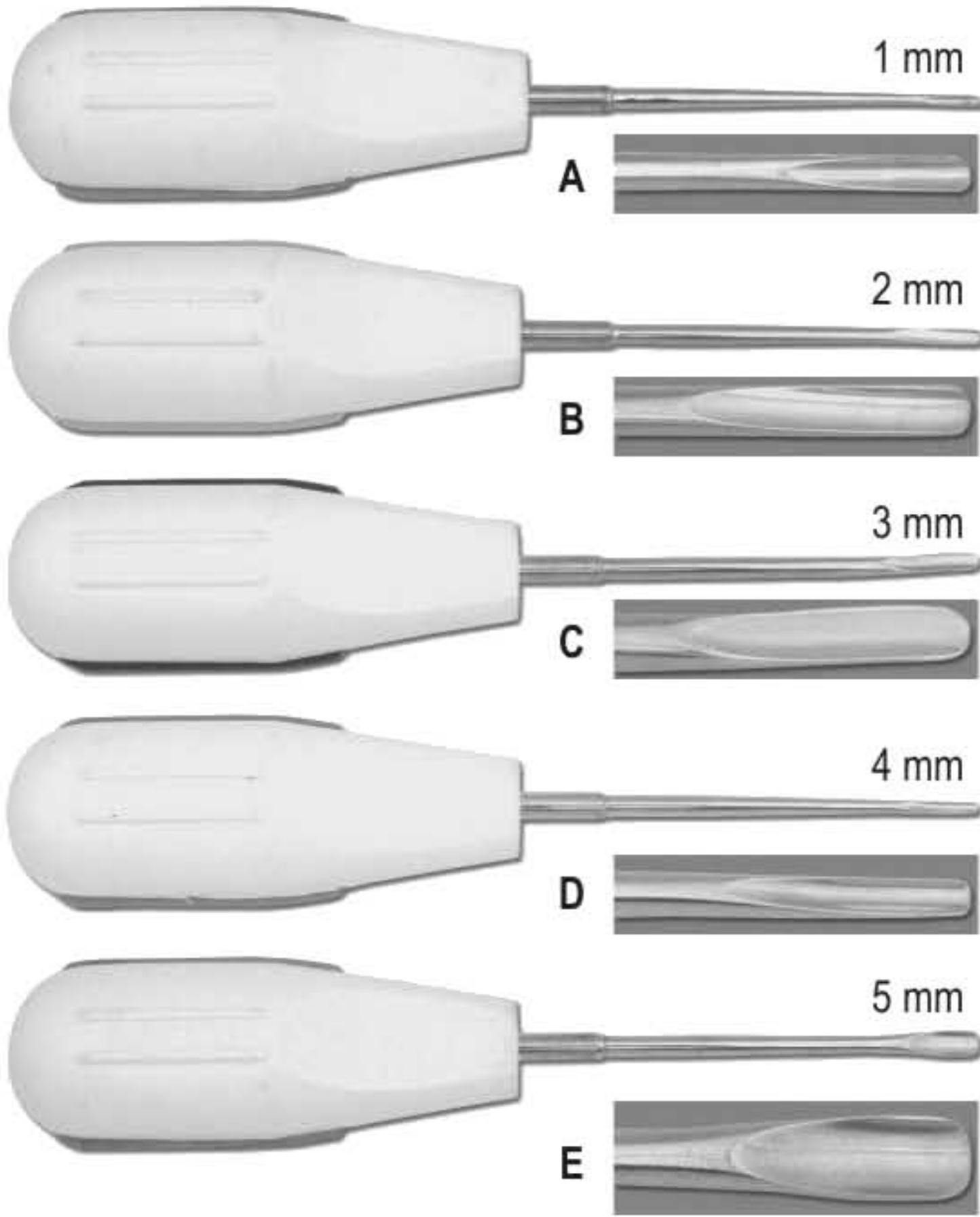

1482  
Root Elevator, Plastic Handle, Set of 5 Pcs

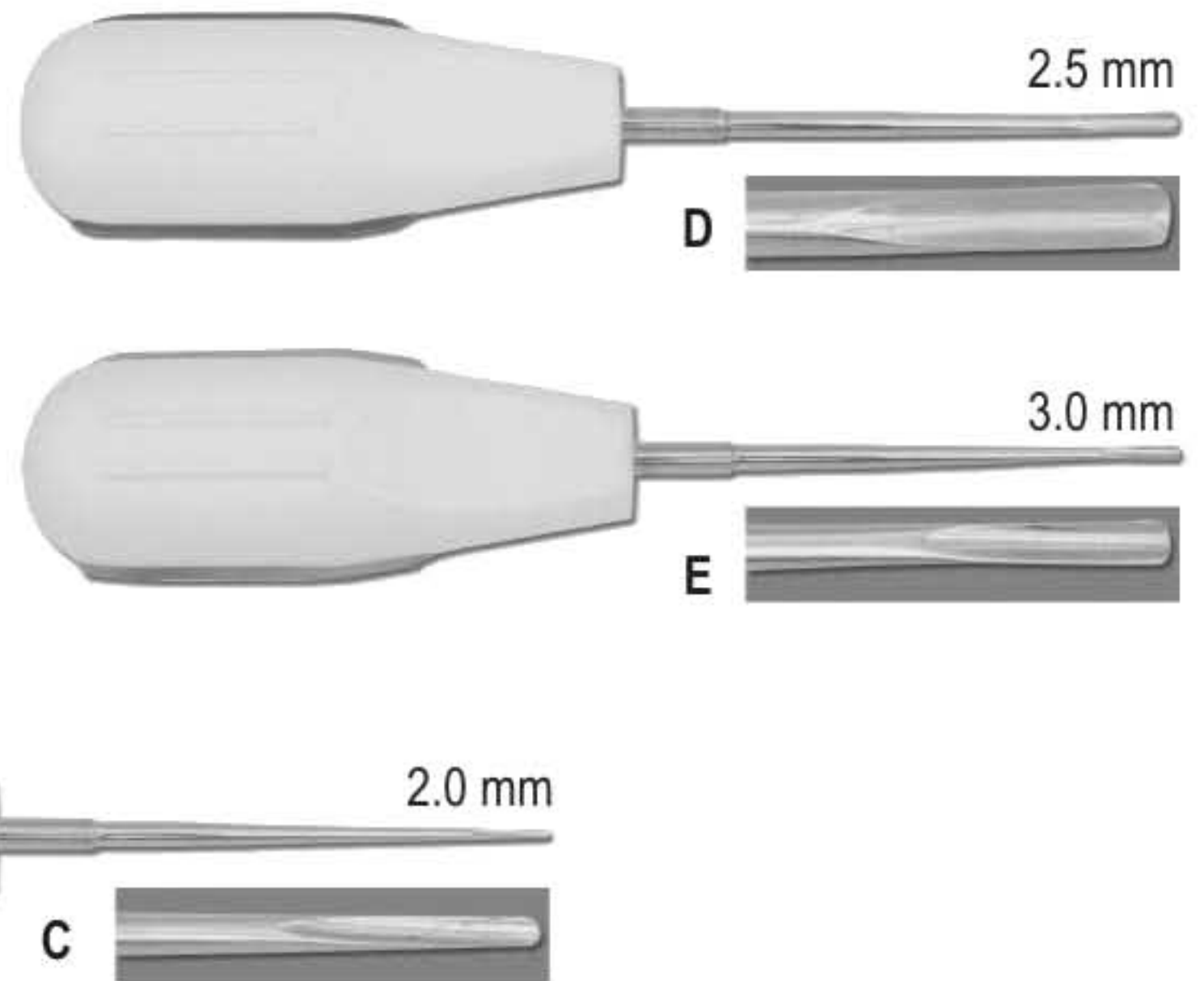
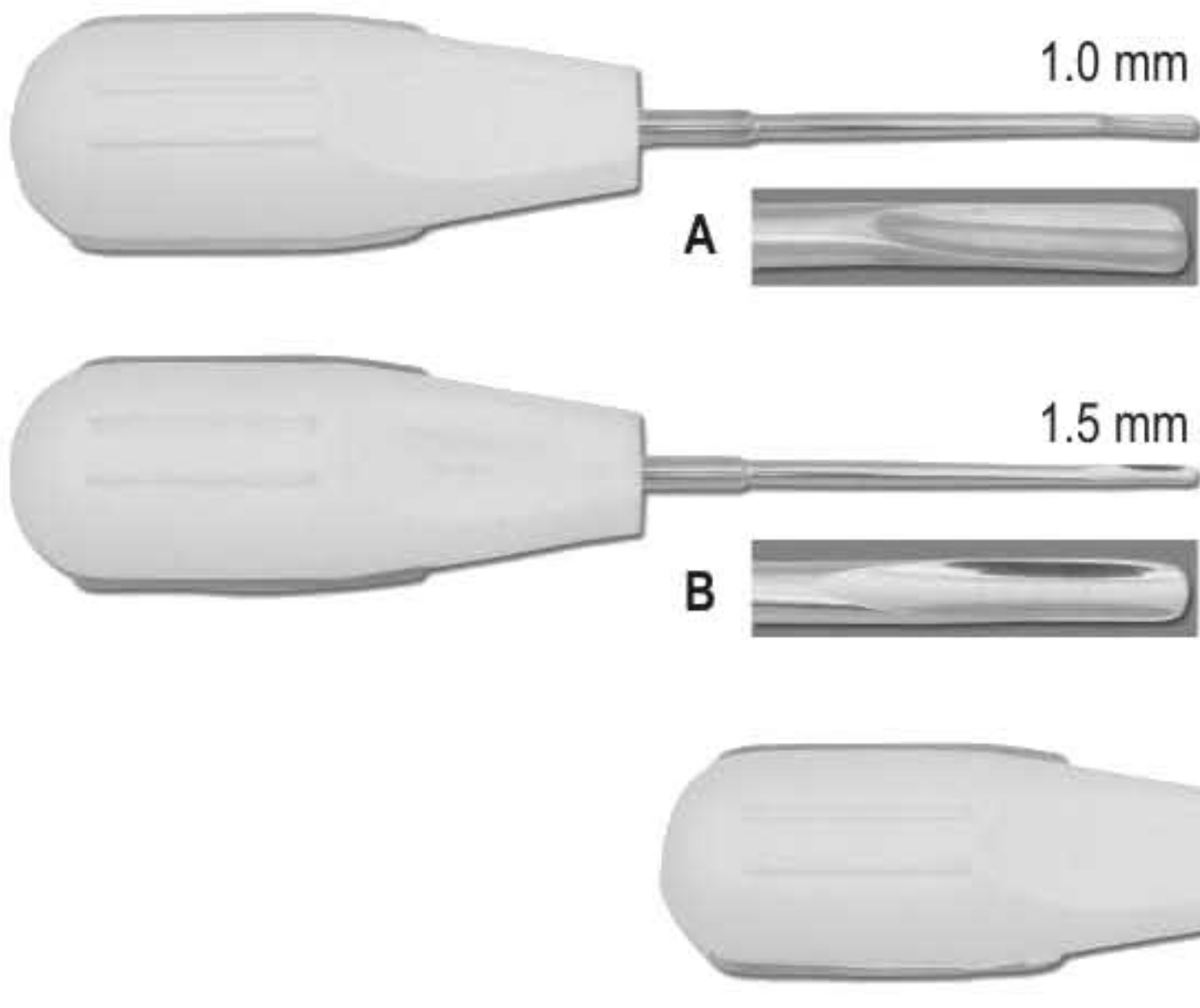

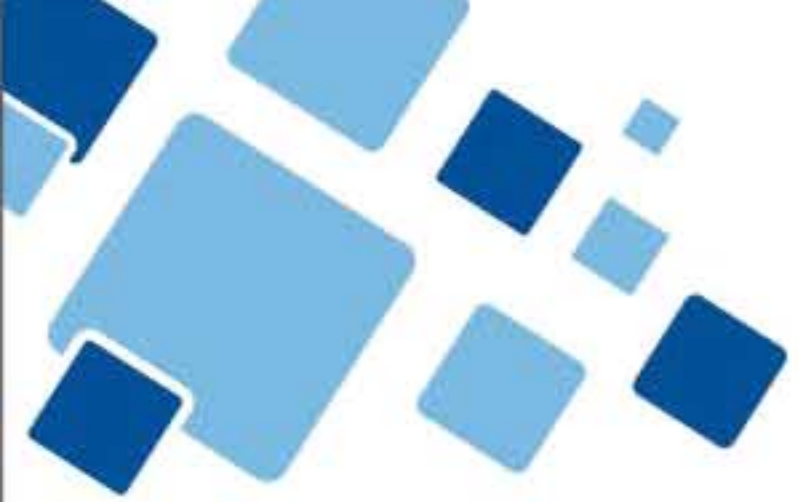

- Scalpel Handles
- Mouth Mirrors and Handles
- Explorer and Probes
- Endodontics
- Excavators



# 02

SECTION





**1483**  
 Scalpel Handle Angle Of Blade Adjusts To Easily Get Around Corners  
 Adjustment Sets Blade From Straight To Back Angled  
 Locks In At 90°, 60°, 30°, Straight, -30°, -60° Angles



**1484**  
 Scalpel Handle  
 Fig. 5



**1485**  
 Scalpel Handle  
 Curved



**1486**  
 Fig. 3L



**1487**  
 Fig. 7



**1488**  
 Scalpel Handle  
 Fig. 4L, Curved  
 20 cm



**1489**  
 Fig. 3



**1490**  
 Fig. 3G



**1491**  
 Fig. 4



**1492**



**1493**  
 Scalpel Handle  
 4 D 14.0 cm



**1494**  
 Mess Holders



**1495**  
 Gouge  
 Blade Handle  
 Fig. 2 / 11.5 cm

Handle For Mouth Mirrors, Probes, Explorers, Excavators, Carvers, Curettes & Scalars



**1496**

Handle No. 2 Standard Single Ended



**1497**

Handle Single Ended



**1498**

Handle Single Ended



**1499**

Handle Single Ended

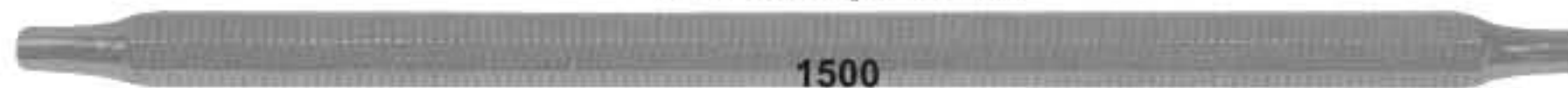

**1500**

Octagonal Double Ended



**1501**

Octagonal Double Ended



**1502**

Octagonal Double Ended

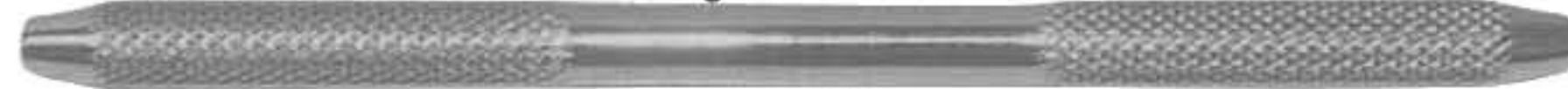

**1503**

Handle No. 2 (Standard Double Ended)



**1504**

Octagonal Double Ended



**1505**

Tactile Tone Double Ended



**1506**

Tactile Tone Double Ended



**1507**

Tactile Tone Double Ended



**1508**

Handle, Double Ended



**1509**

Double Ended



**1510**

Tactile Tone Double Ended



**1511**

Tactile Tone Double Ended

## Mouth Mirrors

Plane



**1514**  
Fig.6  
Ø 26 mm

**1515**  
Fig.5  
Ø 24 mm

**1516**  
Fig.4  
Ø 22 mm

Magnifying



**1517**  
Fig.6  
Ø 26 mm

**1518**  
Fig.5  
Ø 24 mm

**1519**  
Fig.4  
Ø 22 mm

Front surface



**1520**  
Fig.6  
Rhodium  
Ø 26 mm  
Front surface

**1521**  
Fig.5  
Rhodium  
Ø 24 mm  
Front surface

**1522**  
Fig.4  
Rhodium  
Ø 22 mm  
Front surface

Plane

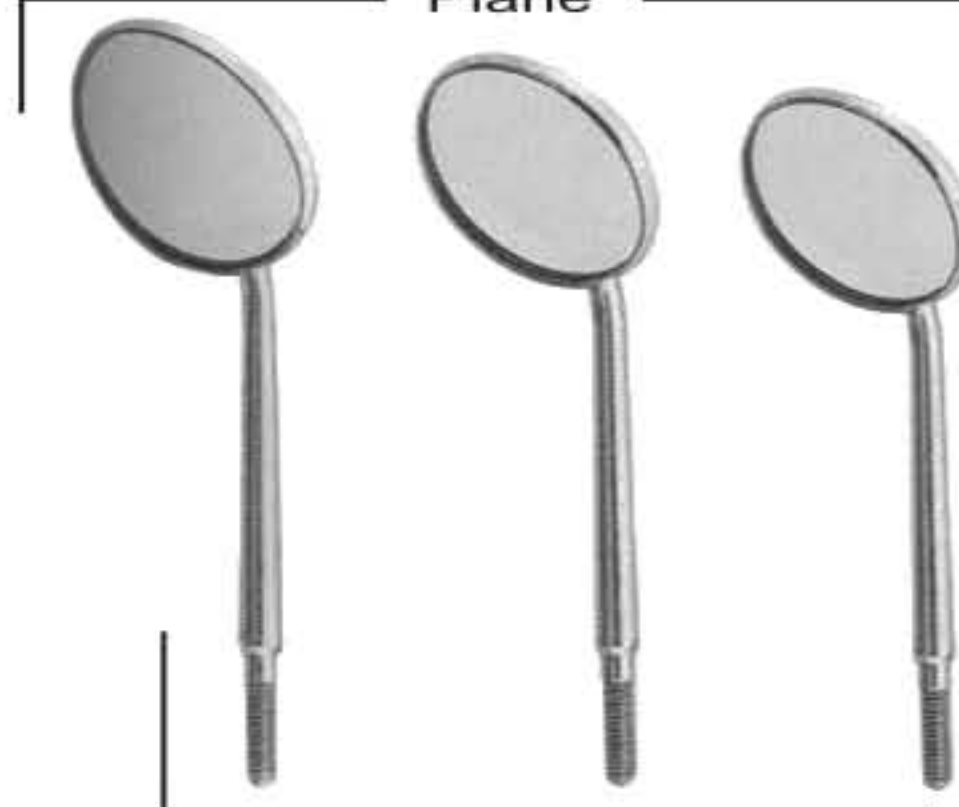

**1523**  
Fig.6  
Ø 26 mm

**1524**  
Fig.5  
Ø 24 mm

**1525**  
Fig.4  
Ø 22 mm

With cone - socket

Magnifying

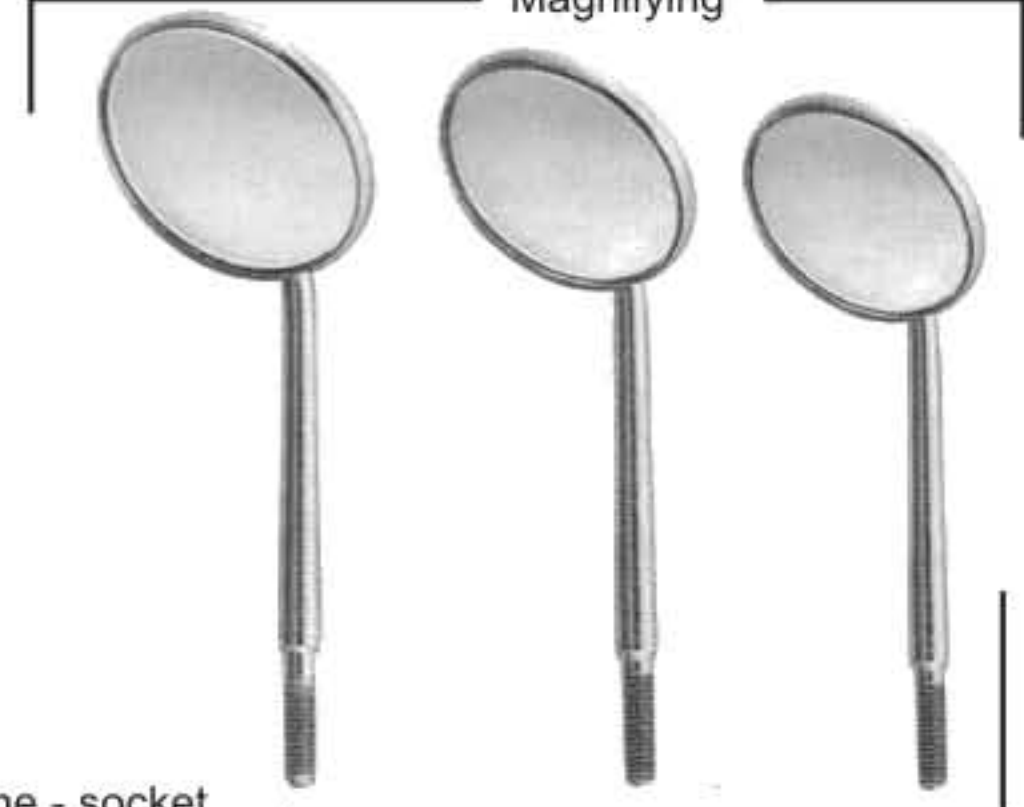

**1526**  
Fig.6  
Ø 26 mm

**1527**  
Fig.5  
Ø 24 mm

**1528**  
Fig.4  
Ø 22 mm

### Mouth Mirrors, Magnifying 1513-A Plain 1512-B

|         |   |       |
|---------|---|-------|
| Fig. 00 | Ø | 8 mm  |
| Fig. 0  | Ø | 10 mm |
| Fig. 1  | Ø | 14 mm |
| Fig. 2  | Ø | 16 mm |
| Fig. 3  | Ø | 18 mm |
| Fig. 4  | Ø | 20 mm |
| Fig. 5  | Ø | 22 mm |
| Fig. 6  | Ø | 24 mm |
| Fig. 7  | Ø | 26 mm |
| Fig. 8  | Ø | 28 mm |
| Fig. 9  | Ø | 30 mm |
| Fig. 10 | Ø | 32 mm |



1513-A



**1512**  
Hollow Handle  
Fig.1



**1513**  
Hollow Handle  
Fig.2



1529



1530



1531



1532



1533



1534



1535  
Parallelometer  
mouth mirror

1536  
Parallelometer  
mouth mirror  
+ handle  
code 2101



1537  
Tactile Tone  
Single Ended



1538  
Handle  
Thompson  
Single Ended



1539  
Hollow Handle



1540  
Hollow Handle  
Stainless  
Steel



1541  
Cone-socket  
Hollow Handle



1542  
Hollow Handle



1543  
Hollow Handle



SCALERS - JAQUETTE

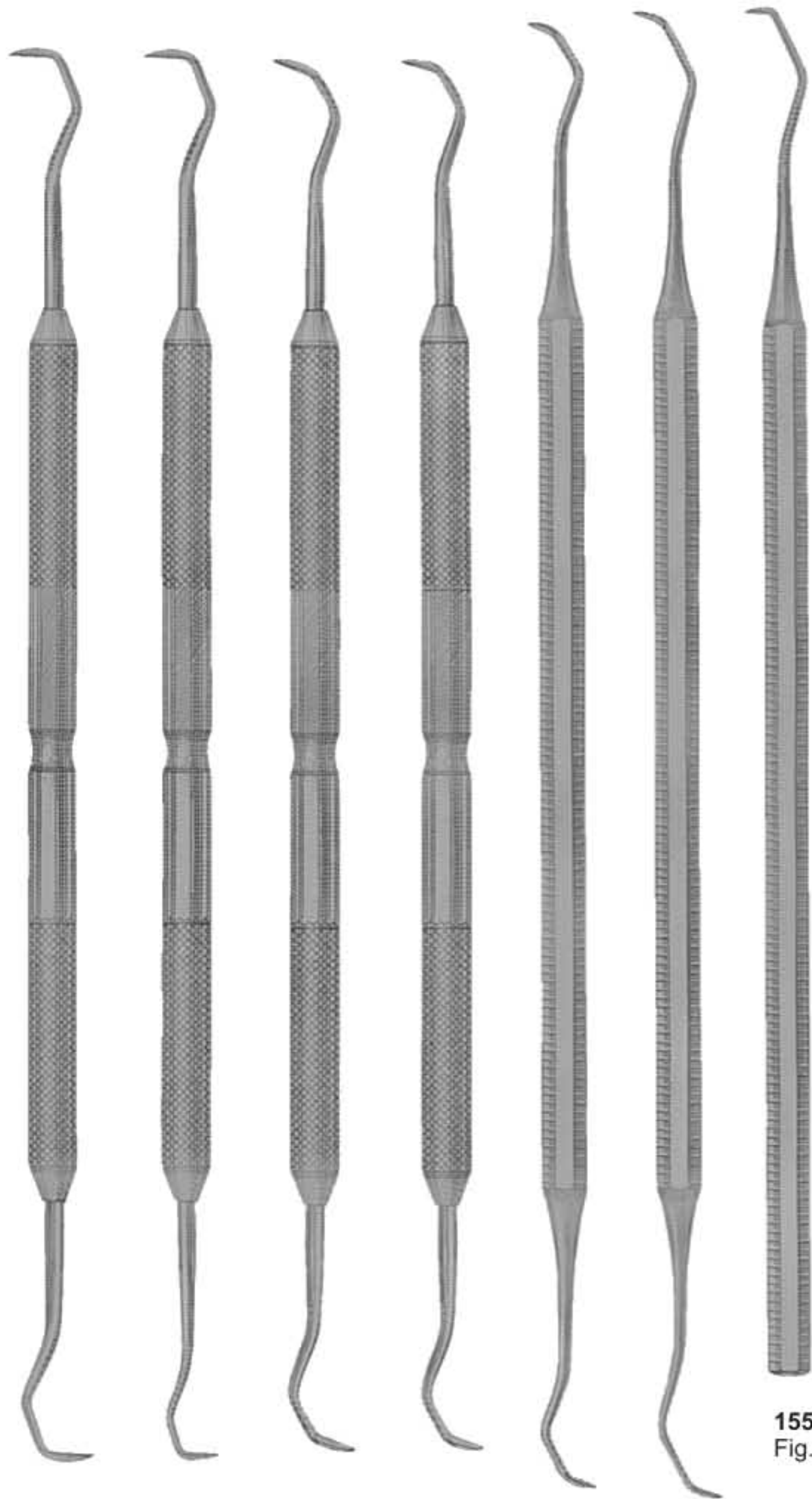

1544 1Y-1Y  
1545 1Y-1YS  
1546 2Y-3Y  
1547 2YS-3YS  
1548 2-3  
1549 2S-3S

1550 Fig.1

SCALERS - OCTAGONAL

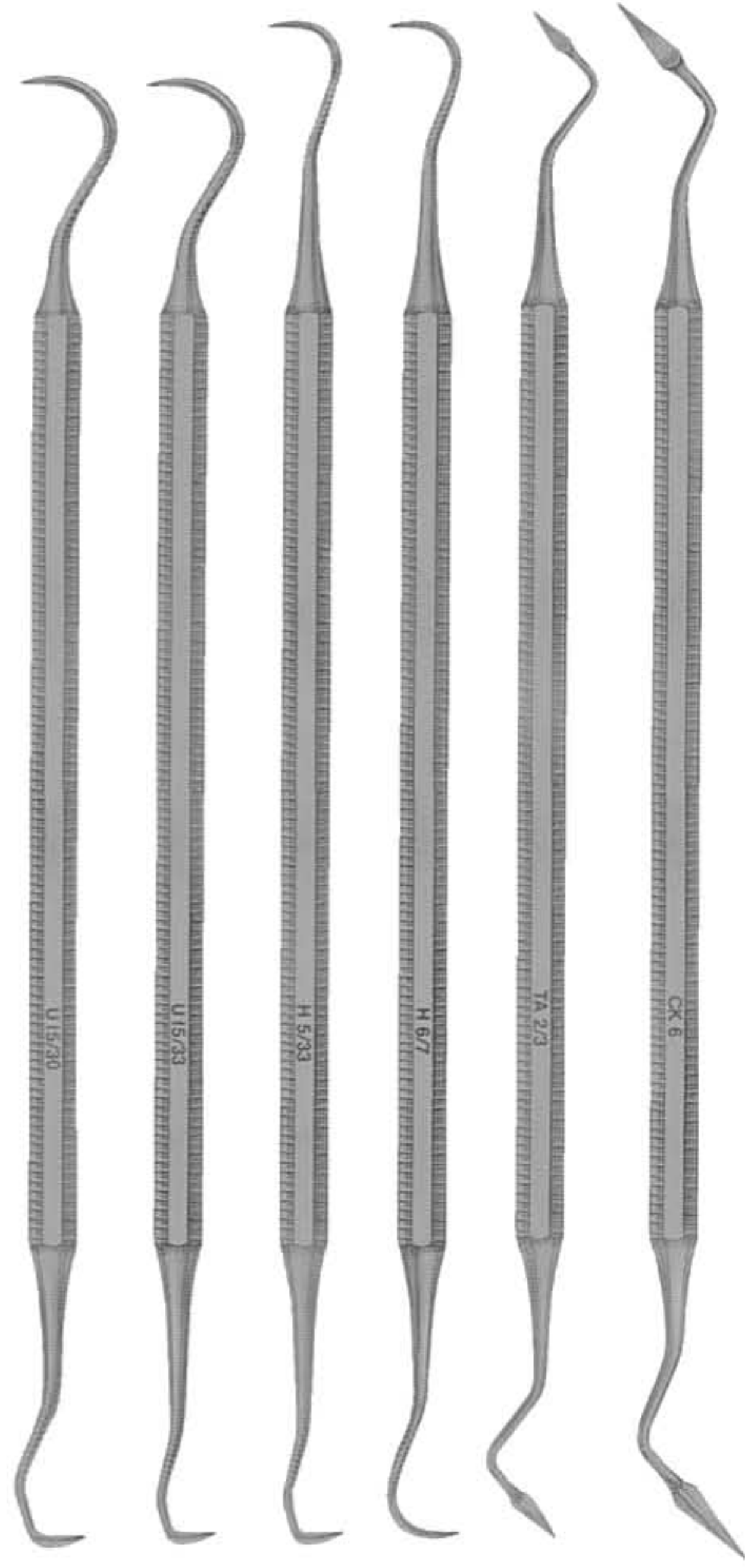

1551 U15-30  
1552 U15-33  
1553 H5-33  
1554 H6-7  
1555 Taylor 2-3  
1556 CK6



**1557**  
U15

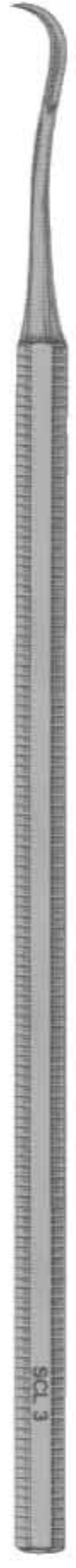

**1558**  
No. 3



**1559**  
No. 12

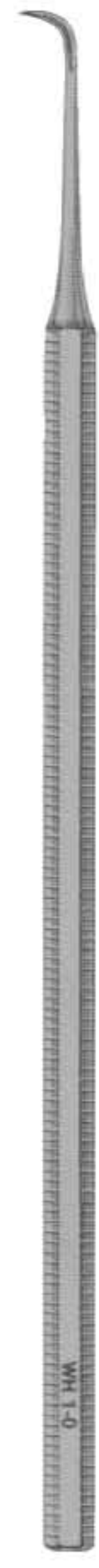

**1560**  
WHITESIDE 1-0

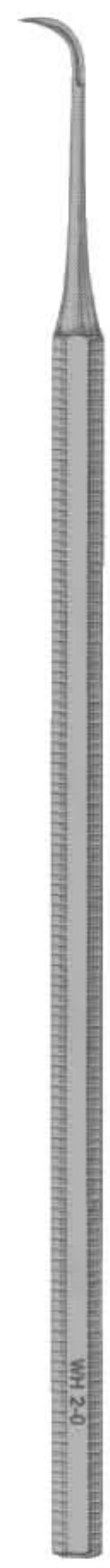

**1561**  
WHITESIDE 2-0





**1562**  
YAOUNGER/GOOD  
7-8



**1563**  
H5-33



**1564**  
204SD



**1565**  
H6-7



**1566**  
204S



**1567**  
TOWNER/JAQUETTE  
U15-30



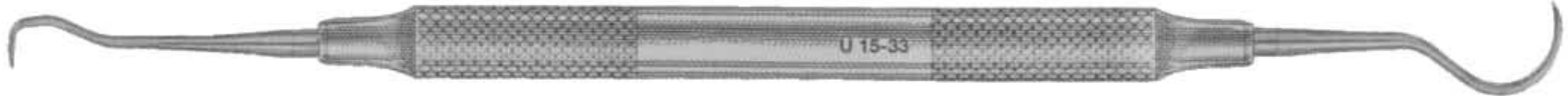

**1568**  
JAQUETTE (33-U15)



**1569**  
JAQUETTE  
2Y-3Y



**1570**  
JAQUETTE  
30-U15



**1571**  
JAQUETTE  
2YS-3YS

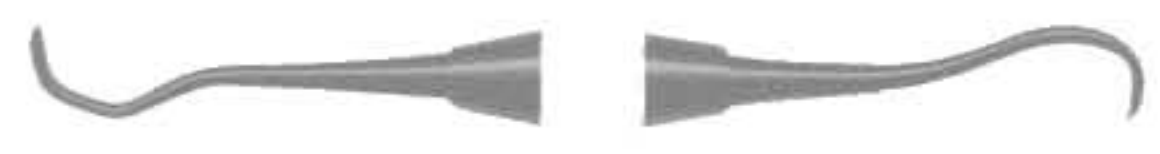

**1572**  
JAQUETTE  
33-H5

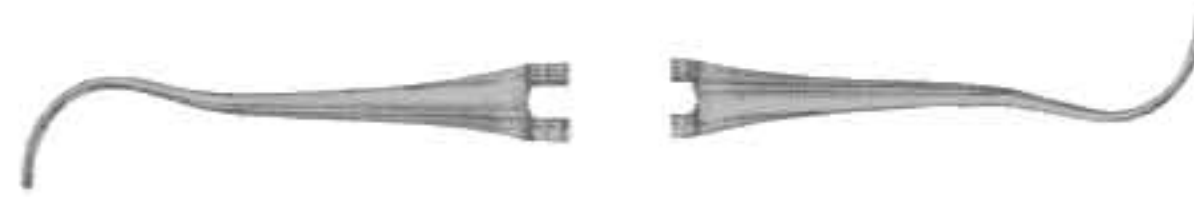

**1573**  
YOUNGER/GOOD  
7-8

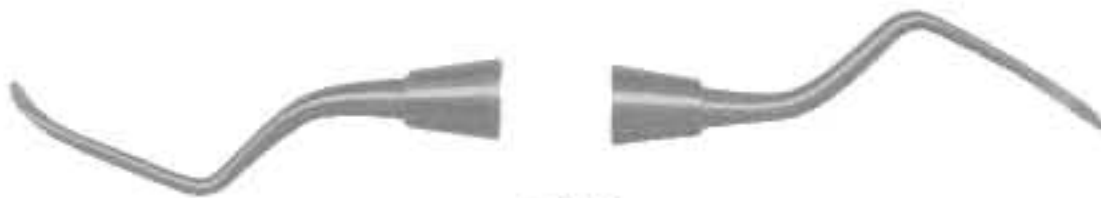

**1574**  
204S

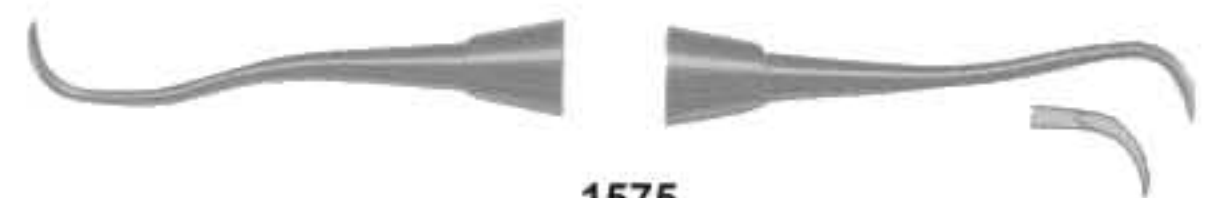

**1575**  
204SD



**1576**  
H6-7

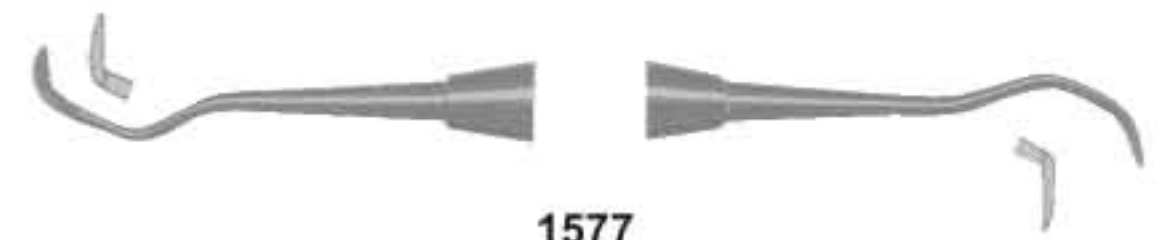

**1577**  
JAQUETTE  
2S-3S



**1578**  
JAQUETTE  
1Y-1YS



**1579**  
JAQUETTE  
2-3



**1580**  
JAQUETTE (33-U15)

- |  |                               |  |                                |
|--|-------------------------------|--|--------------------------------|
|  | <b>1581</b><br>S204           |  | <b>1582</b><br>Jack-Nebraska   |
|  | <b>1583</b><br>S204S          |  | <b>1584</b><br>Jaquette 1-U15  |
|  | <b>1585</b><br>S204SD         |  | <b>1586</b><br>Jaquette 2-3    |
|  | <b>1587</b><br>Goldman 6-7    |  | <b>1588</b><br>Jaquette 2S-3S  |
|  | <b>1589</b><br>Goldman Fox 21 |  | <b>1590</b><br>Jaquette 30-U15 |
|  | <b>1591</b><br>H5-U15         |  | <b>1592</b><br>Jaquette 30-33  |
|  | <b>1593</b><br>Jaquette 34-35 |  | <b>1594</b><br>Jaquette 31-32  |
|  | <b>1595</b><br>Thompson Jr.   |  | <b>1596</b><br>Jaquette 33-H5  |
|  | <b>1597</b><br>UT107-108      |  | <b>1598</b><br>U 6-7           |
|  | <b>1599</b><br>UP128          |  | <b>1600</b><br>128L            |



Explorers Double Ended - Octagonal

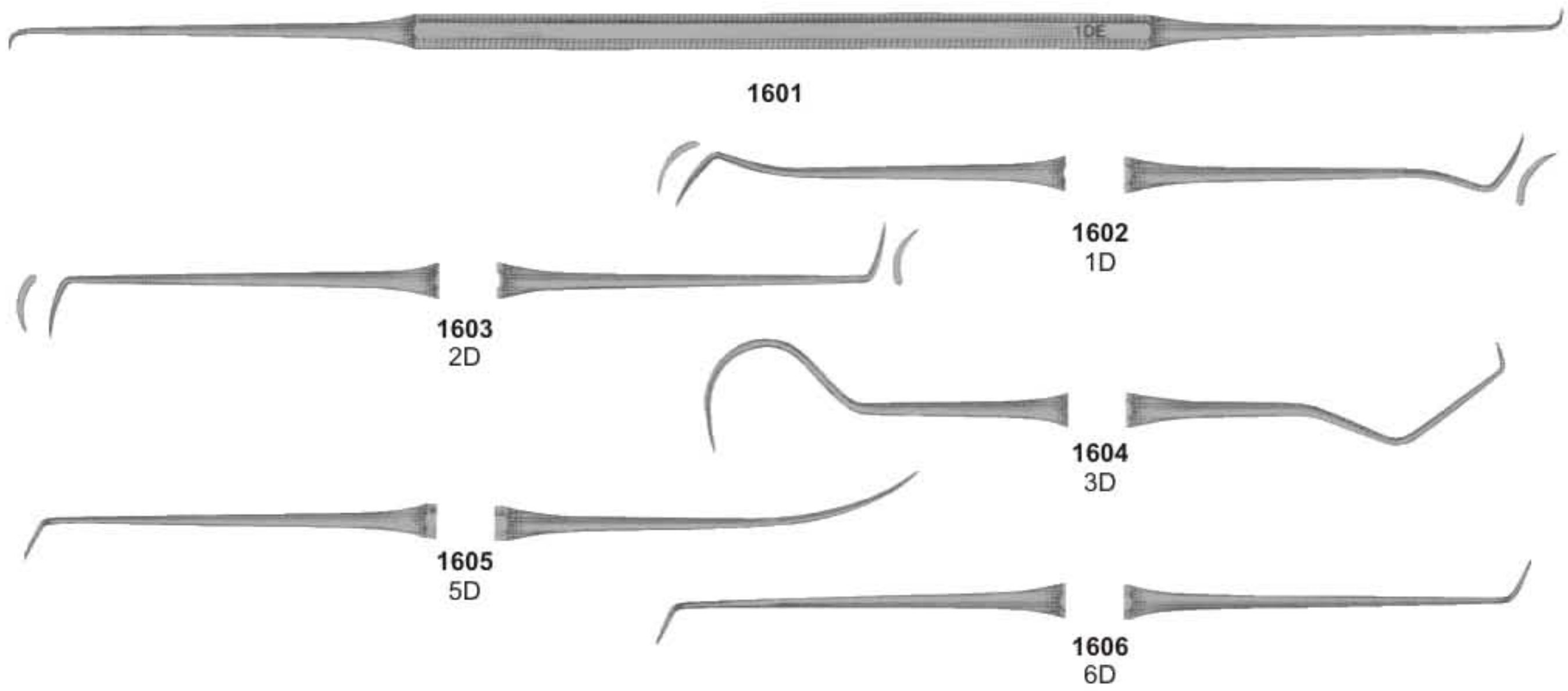

Explorers Double Ended - Standard

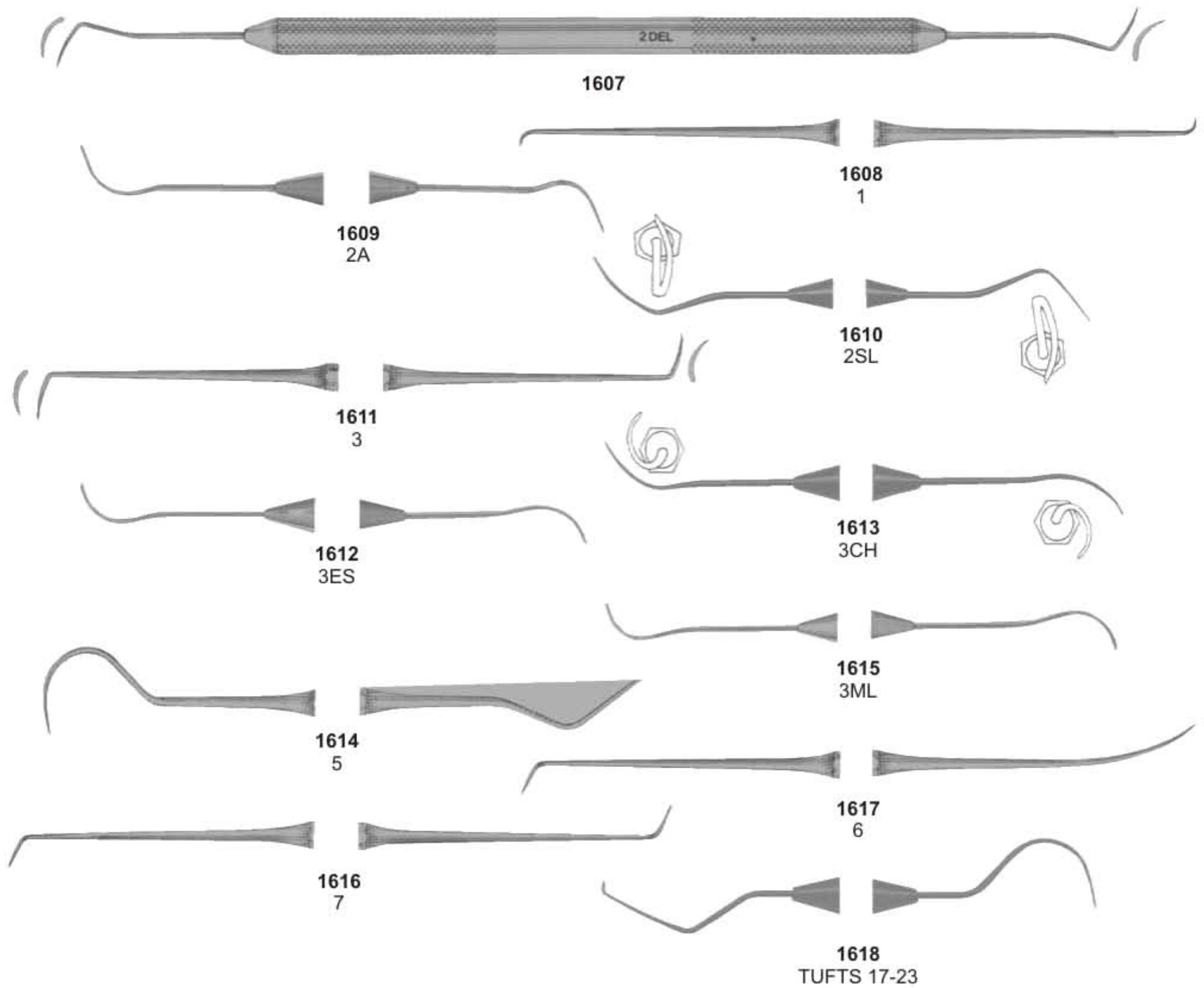

Explorers Double Ended Tactile Tone



1619  
2A



1620  
2



1621  
1



1622  
2SL

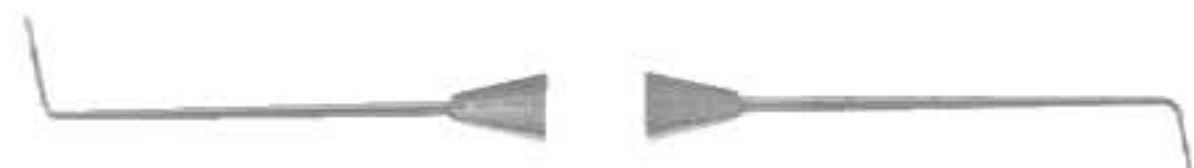

1623  
3



1624  
3CH



1625  
3ES

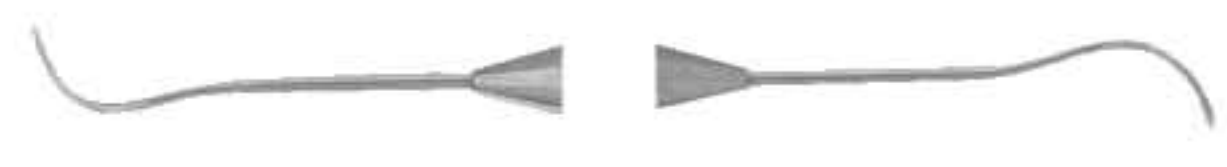

1626  
3ML

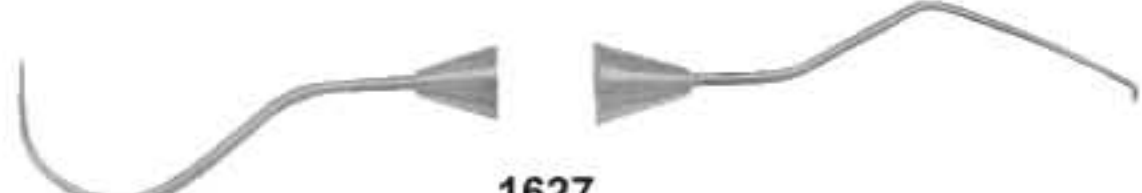

1627  
5



1628  
6

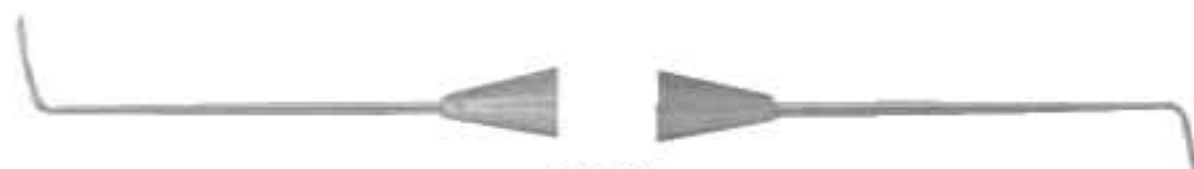

1629  
7

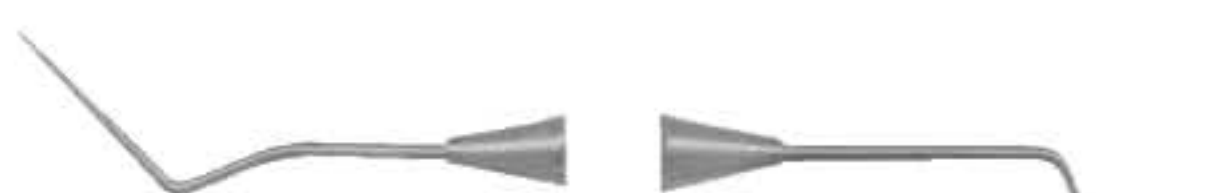

1630  
16

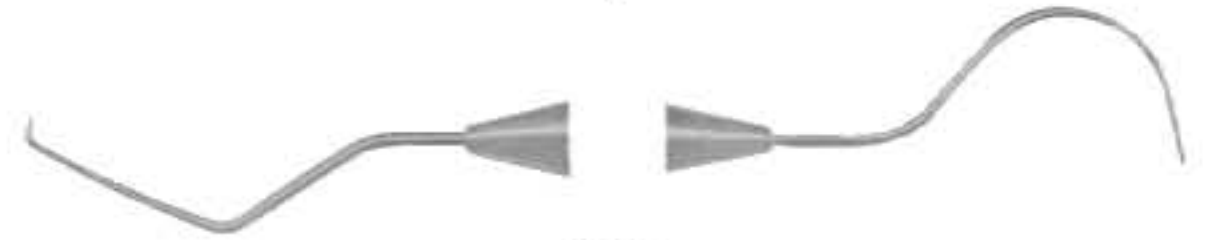

1631  
TUFTS 17/23



Explorers Single Ended - Octagonal

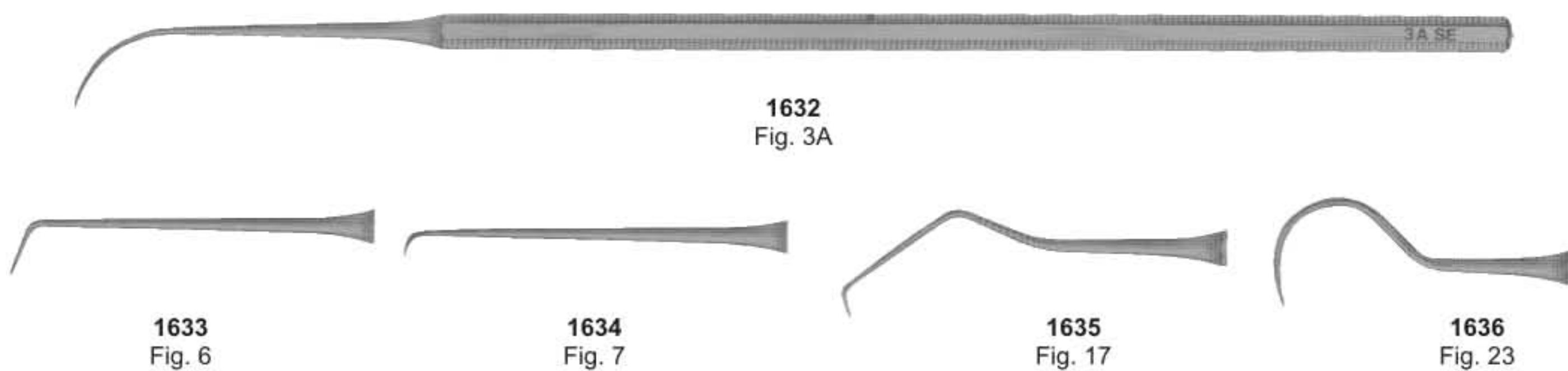

Explorers Single Ended - Standard

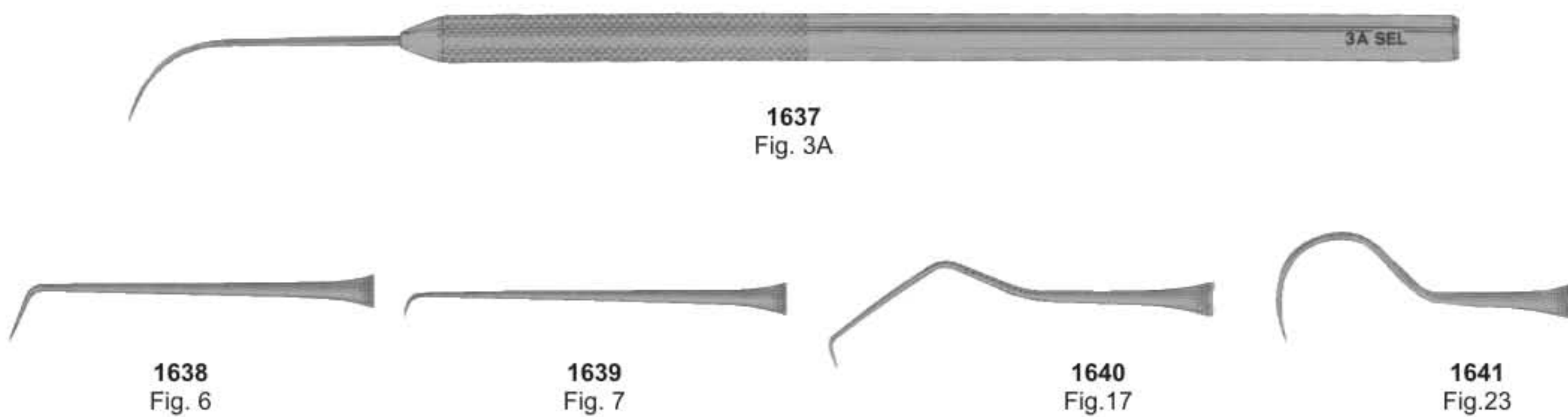

Probe / Explorer - Octagonal

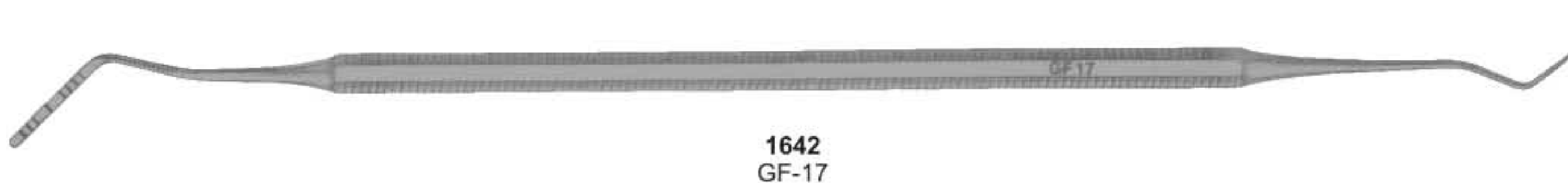

Double Ended Probe - Octagonal

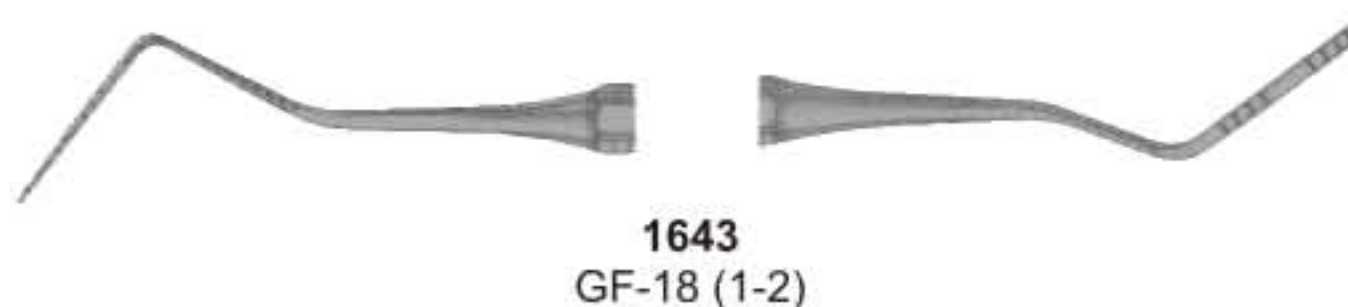



Probes Double Ended - Standard

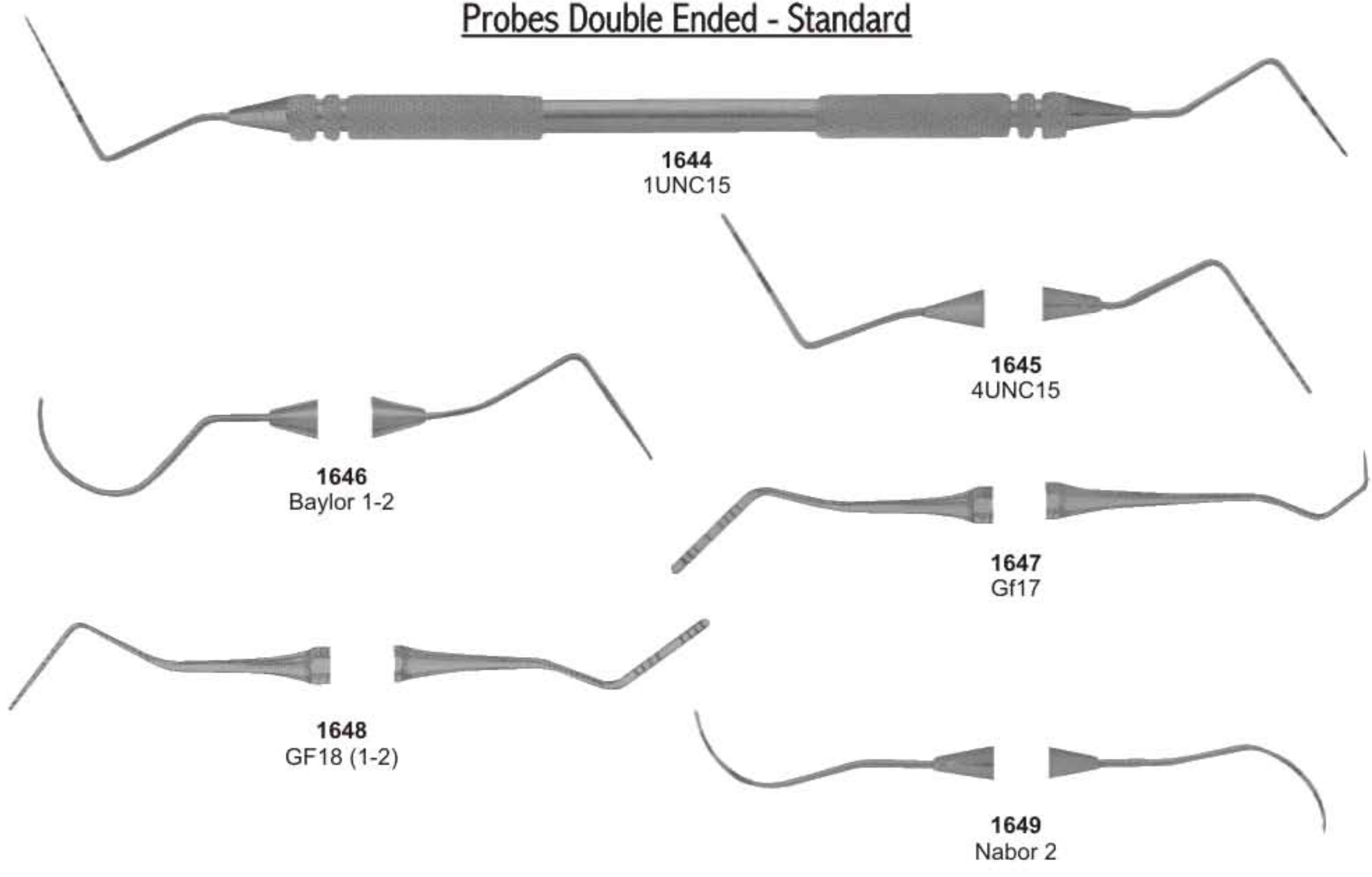

Probes Double Ended - Tactile Tone

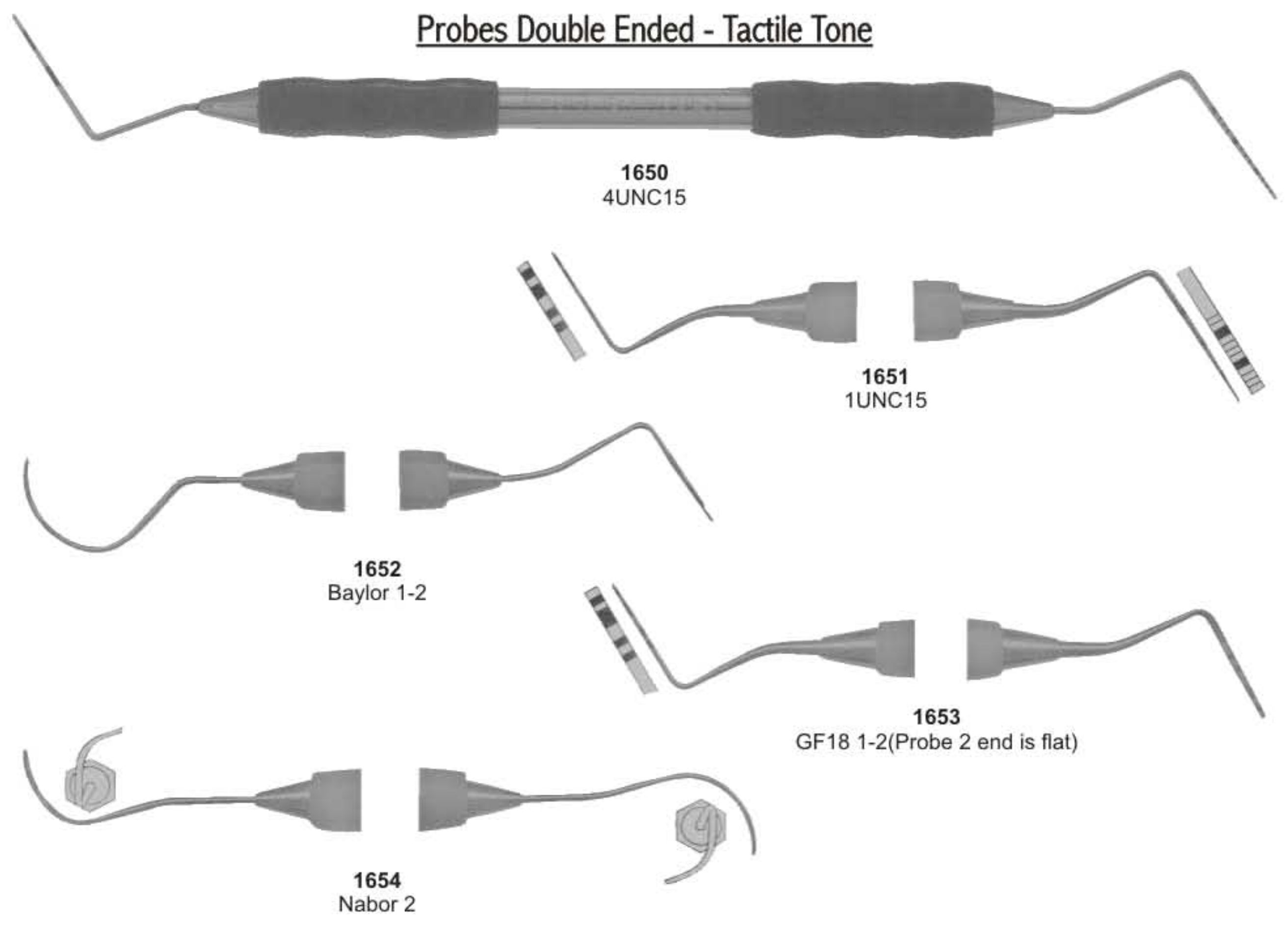

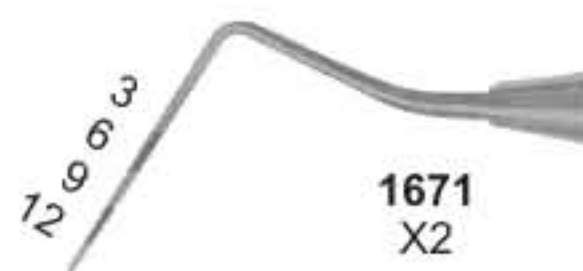
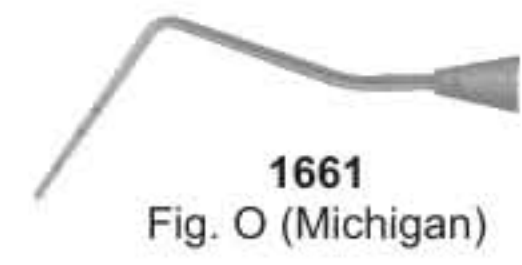
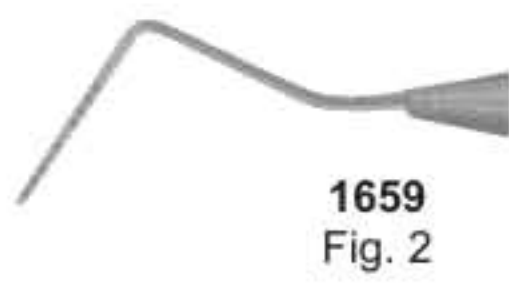
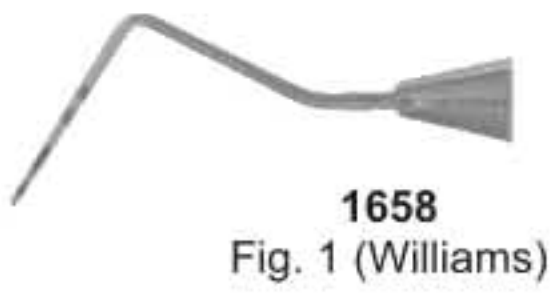
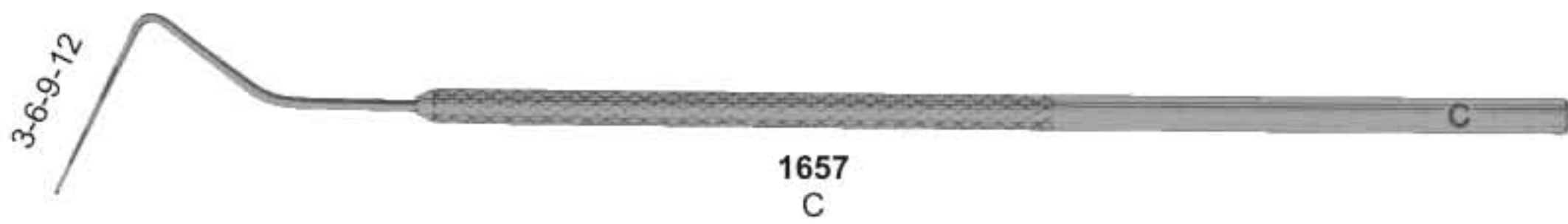
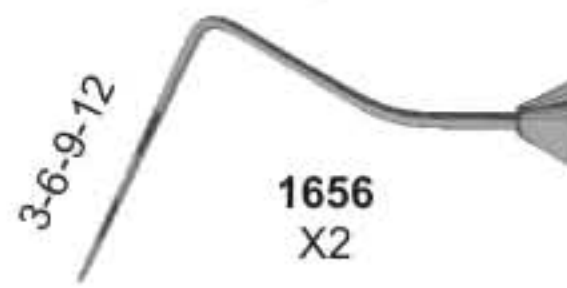
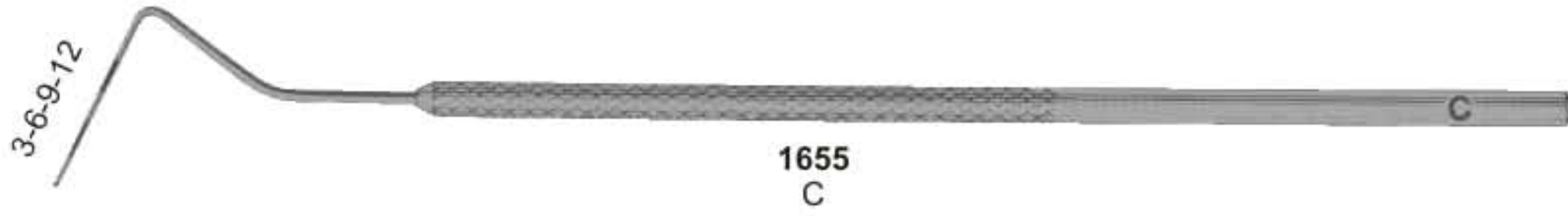

**PROBES DOUBLE ENDED STANDARD**

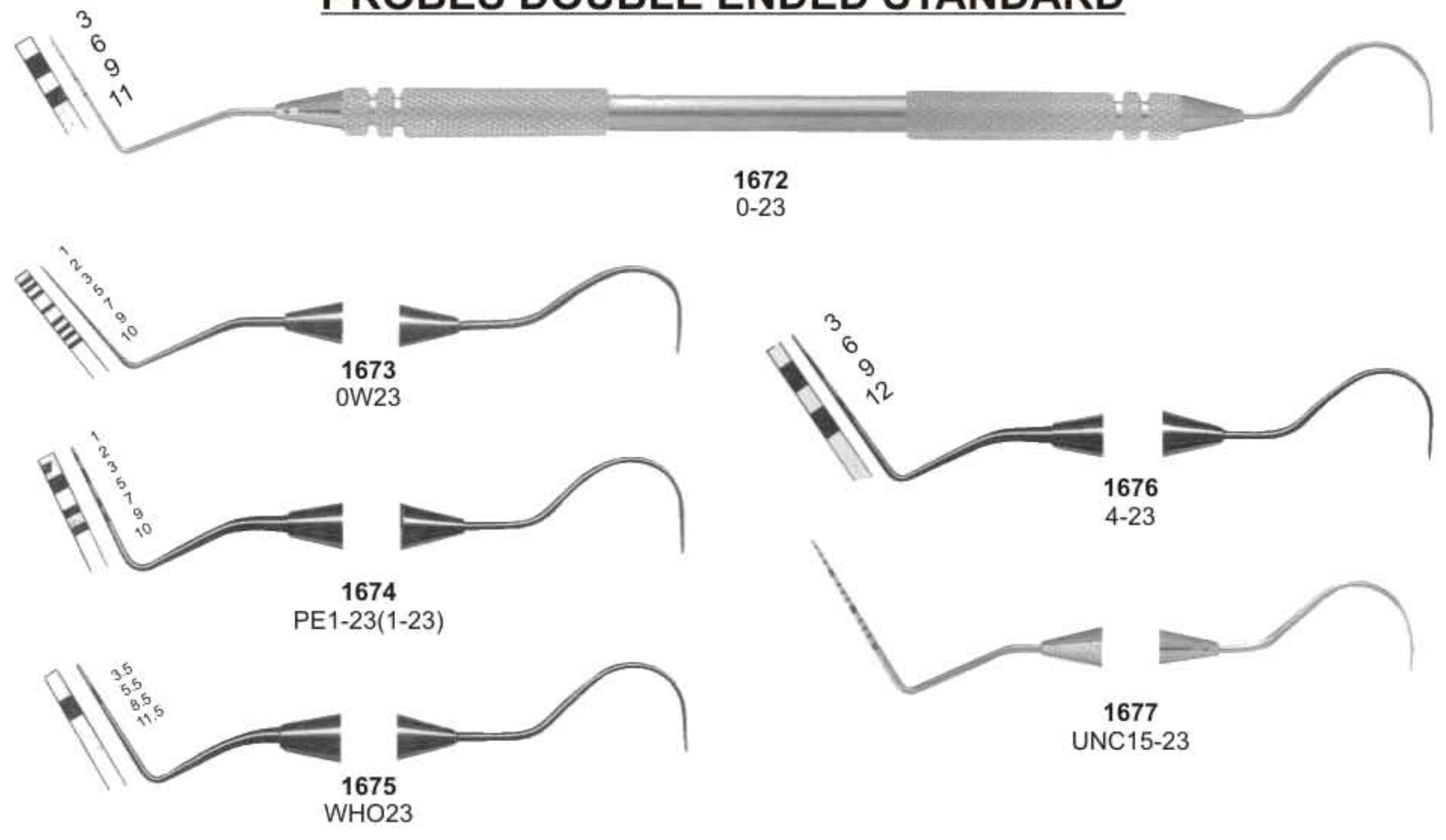

**PROBES DOUBLE ENDED TACTILE TONE**

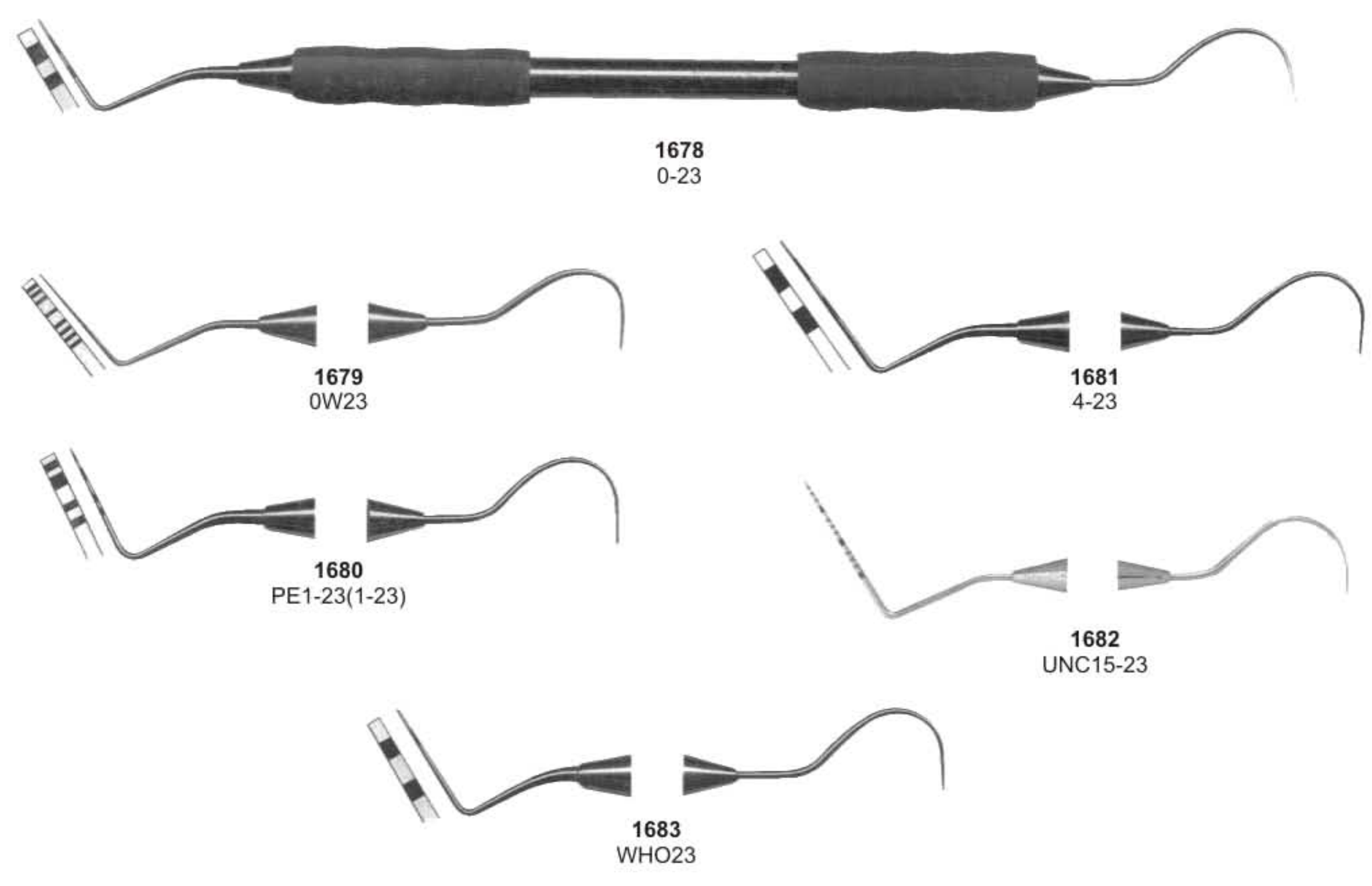

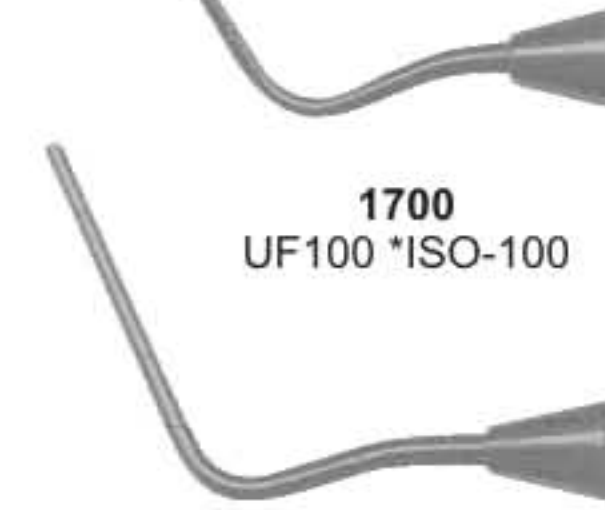
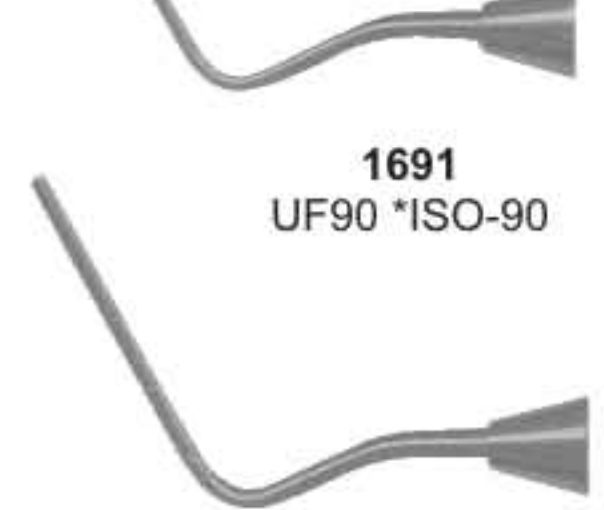
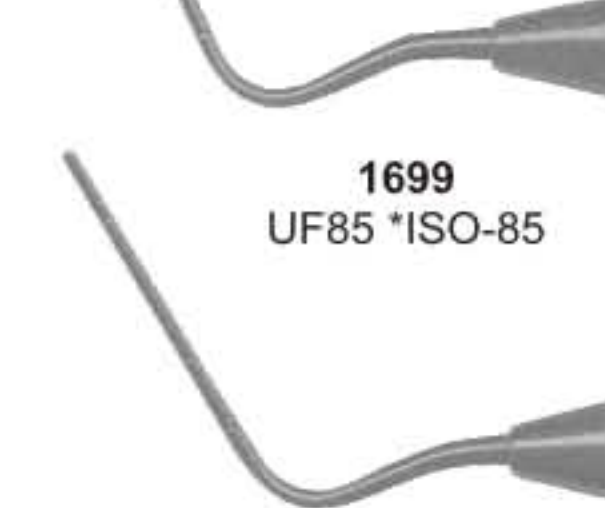
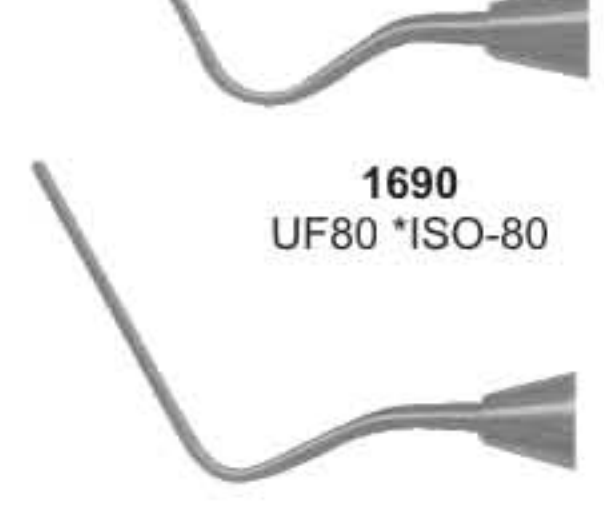
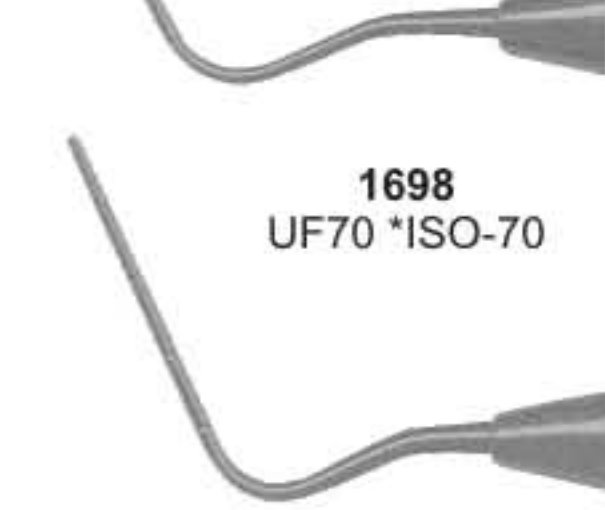
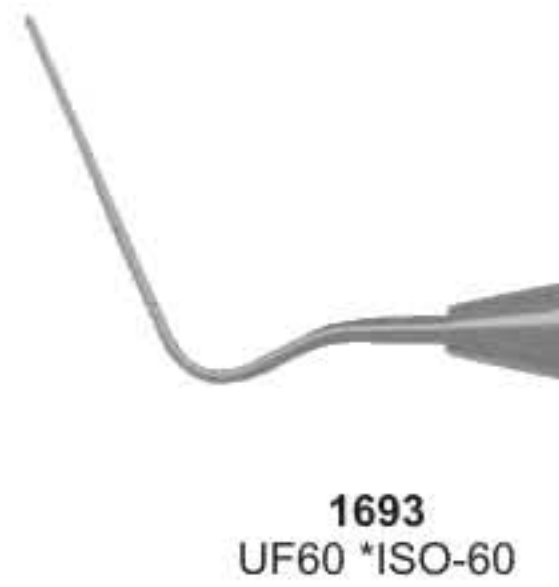
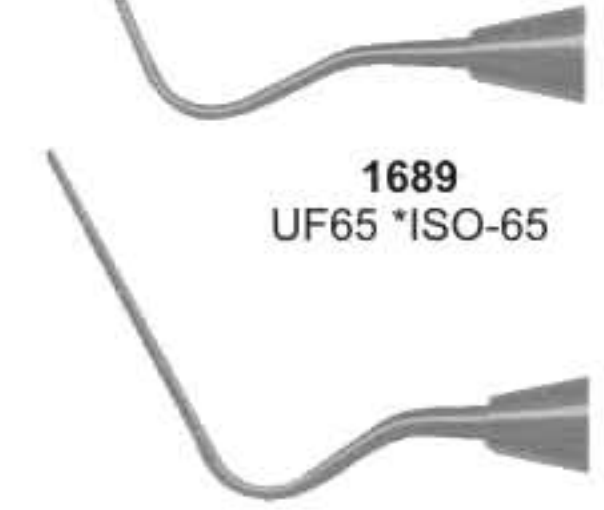
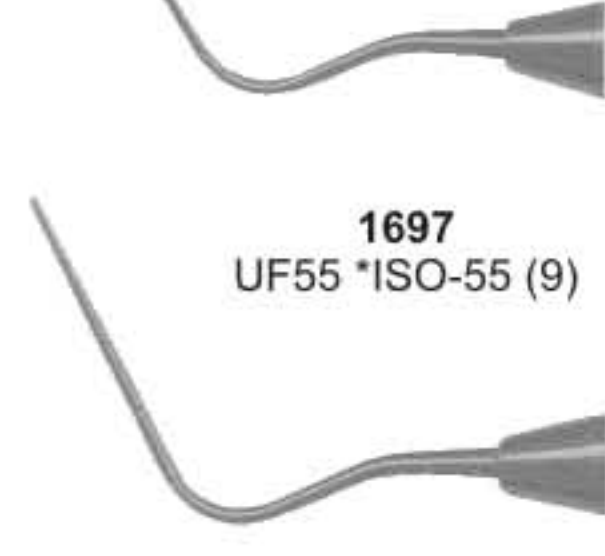
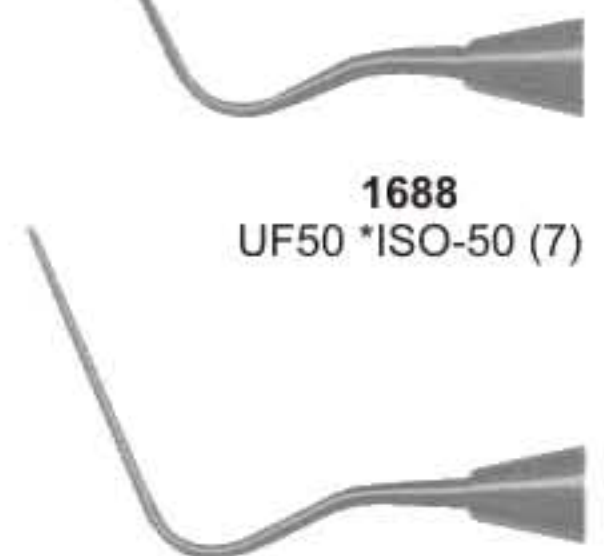
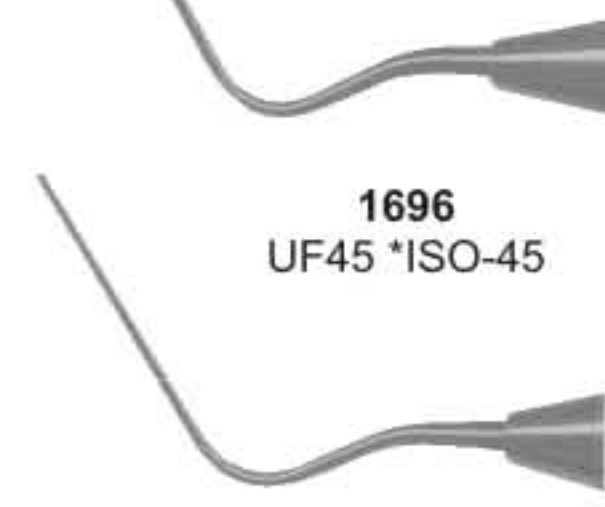
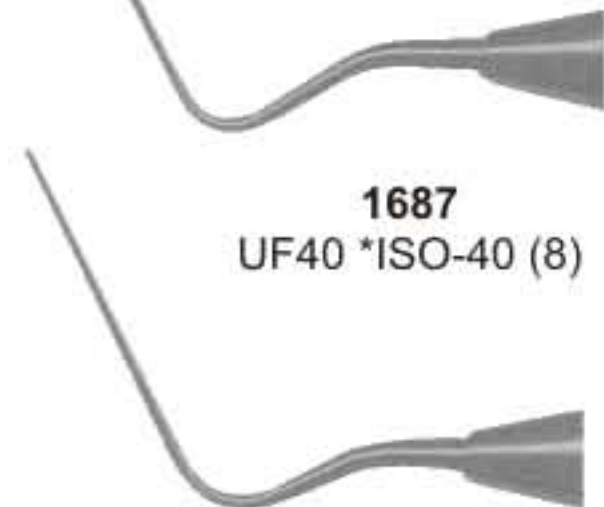
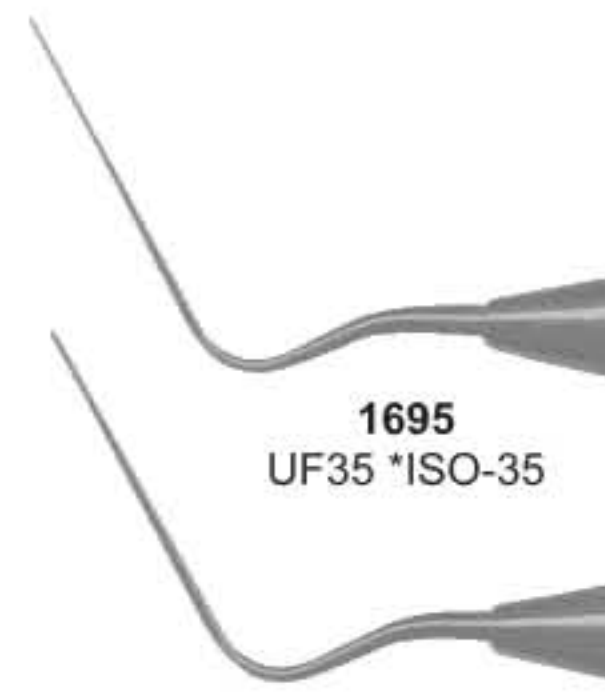
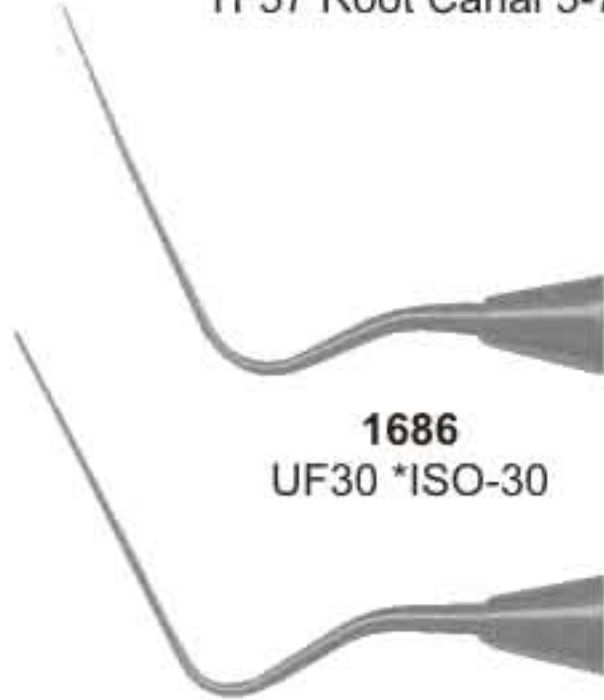
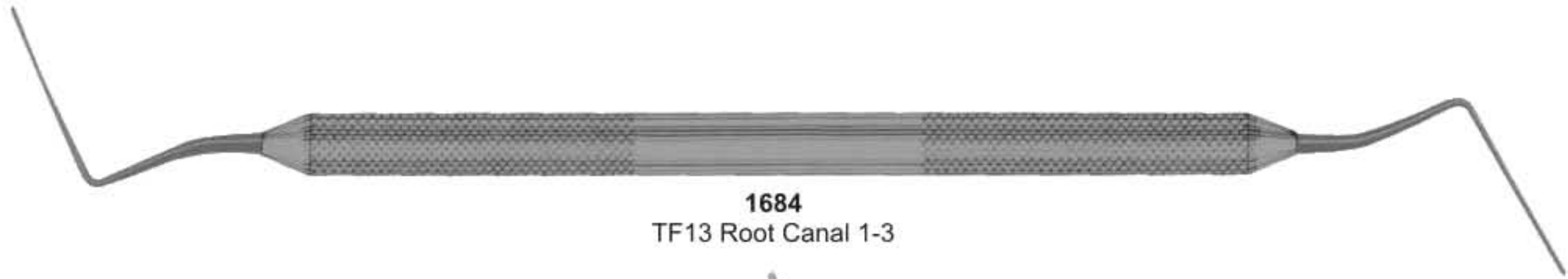



**1702**  
UF120X



**1703**  
UF45N



**1704**  
UF60N



**1705**  
UF80N



**1706**  
UF100X



**1707**  
UE25 R-25



**1708**  
UE30 R-30



**1709**  
UE35 R-35



**1710**  
UE40 R-40



**1711**  
UE45 R-45



**1712**  
UE50 R-50



**1713**  
UF120X



**1714**  
UF140X



**1715**  
TFD3545N



**1716**  
TFD6080N



**1717**  
UE55 R-55



**1718**  
UE60 R-60



**1719**  
UE25N R-25

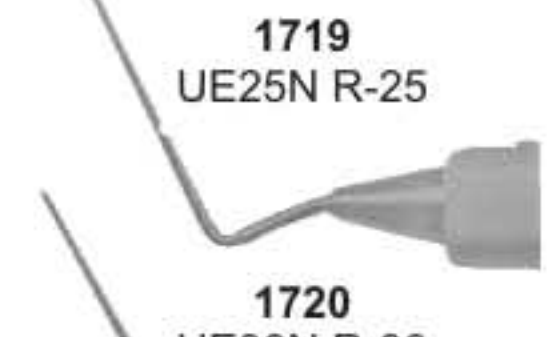

**1720**  
UE30N R-30



**1721**  
UE40N R-40



**1722**  
No. D11

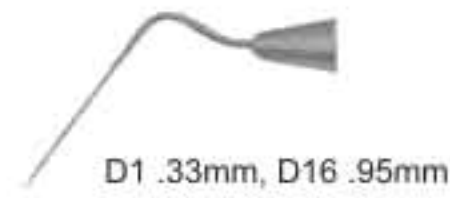

**1723**  
No. D11T

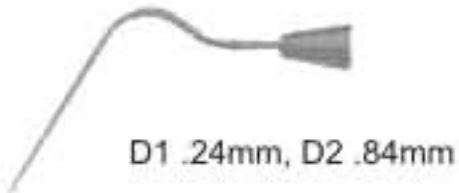

**1724**  
No. KR1



**1725**  
No. 25S

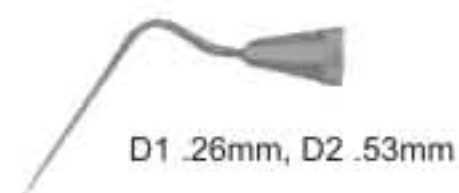

**1726**  
No. W1S

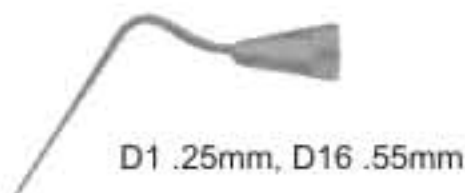

**1727**  
No. W2S



**1728**  
Lucks No.1



**1729**  
Lucks No.2



**1730**  
Lucks No.3



**1731**  
Lucks No.4

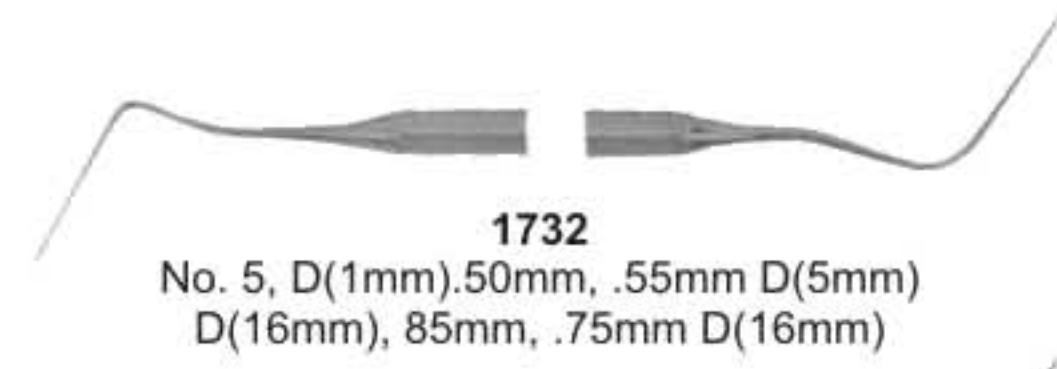

**1732**  
No. 5, D(1mm).50mm, .55mm D(5mm)  
D(16mm), 85mm, .75mm D(16mm)

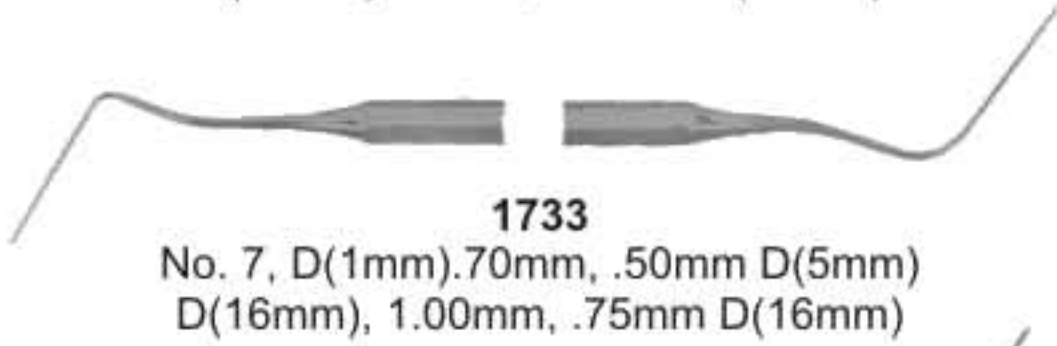

**1733**  
No. 7, D(1mm).70mm, .50mm D(5mm)  
D(16mm), 1.00mm, .75mm D(16mm)

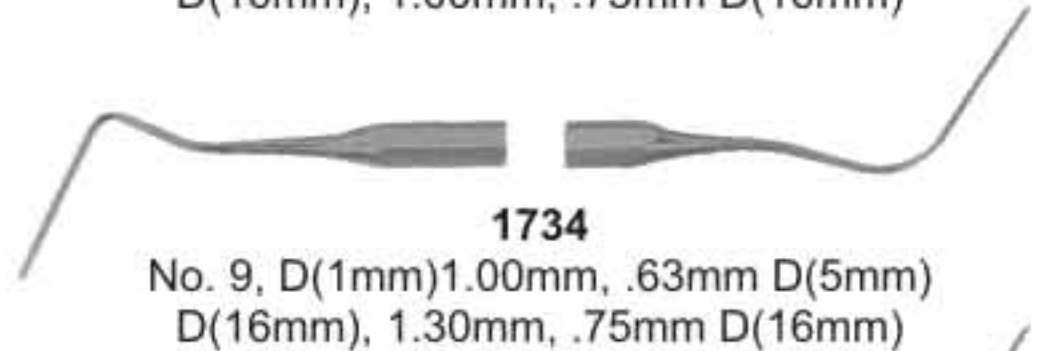

**1734**  
No. 9, D(1mm)1.00mm, .63mm D(5mm)  
D(16mm), 1.30mm, .75mm D(16mm)



**1735**  
No. 11, D(1mm)1.20mm, .63mm D(5mm)  
D(16mm), 1.50mm, .75mm D(16mm)



**1736**  
No.1 (D1 .35mm, D16 .75mm)



**1737**  
No.2 D1 .55mm, D16 .85mm



**1738**  
No.3 D1 .85mm, D16 1.15mm



**1739**  
No.4 D1 1.00mm, D16 1.30mm



**1740**  
No.1-3 - D1 .25mm/D1 .35mm



**1741**  
No.3-5 - D1 .35mm/D1 .55mm



**1742**  
No.5-7 - D1 .55mm/D1 .70mm



**1743**  
No.9-11 - D1 1.00mm/D1 1.20mm

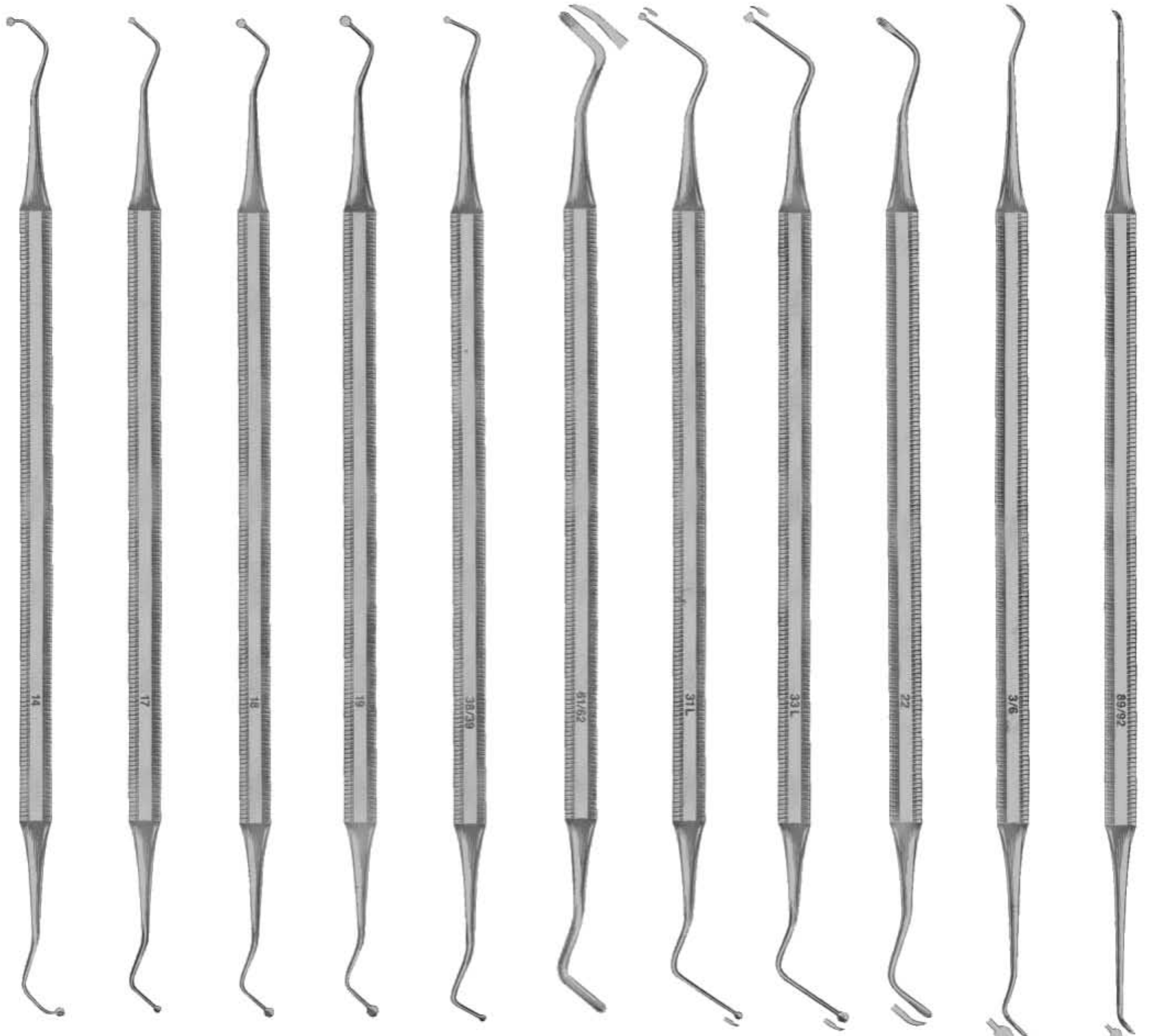

**1744**  
No. 14

**1745**  
No. 17

**1746**  
No. 18

**1747**  
No. 19

**1748**  
No. 38/39

**1749**  
No. 61/62

**1750**  
No. 31L

**1751**  
No. 33L

**1752**  
No. 22

**1753**  
No. 3/6

**1754**  
No. 89/92

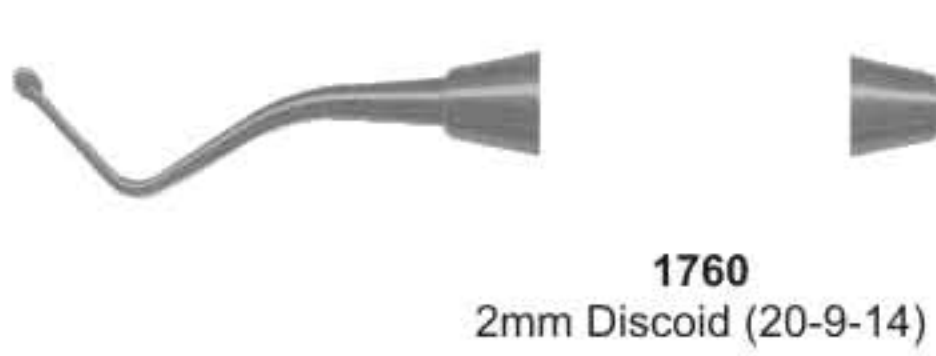
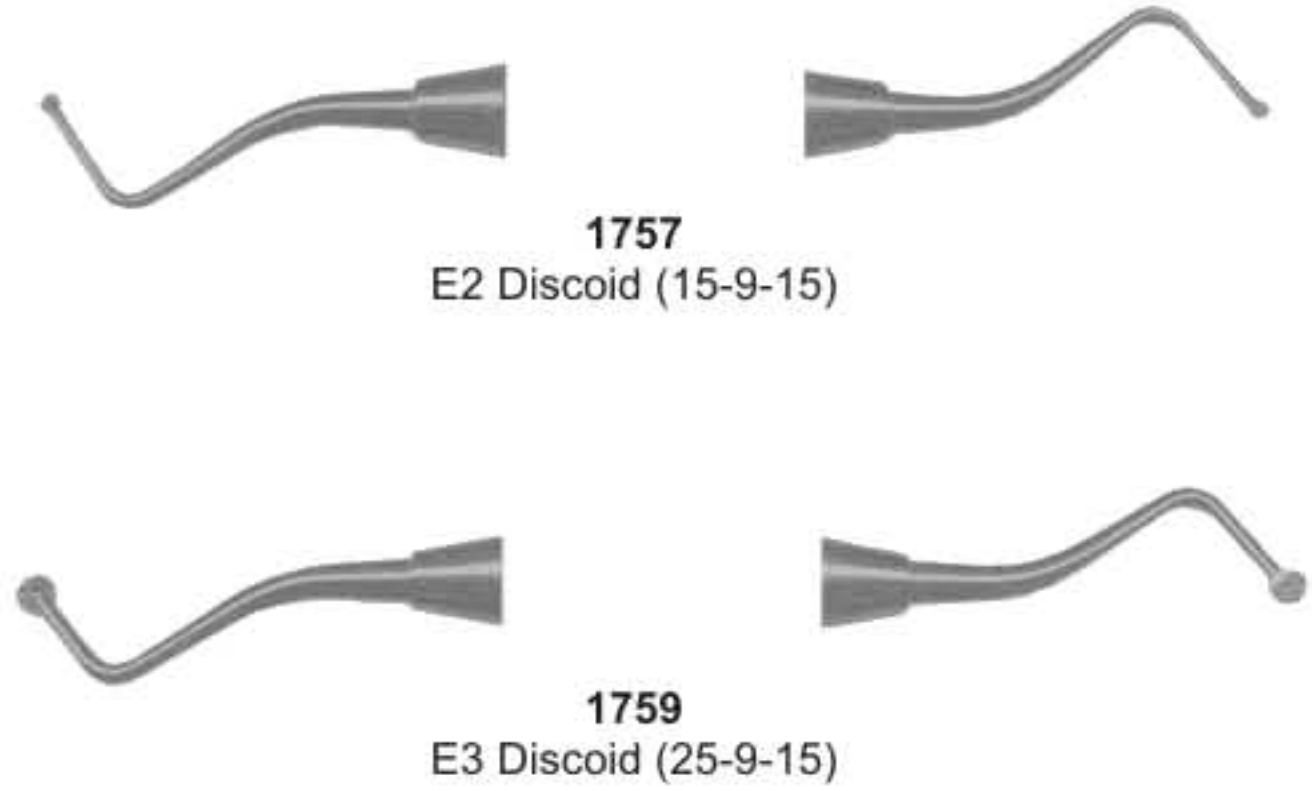
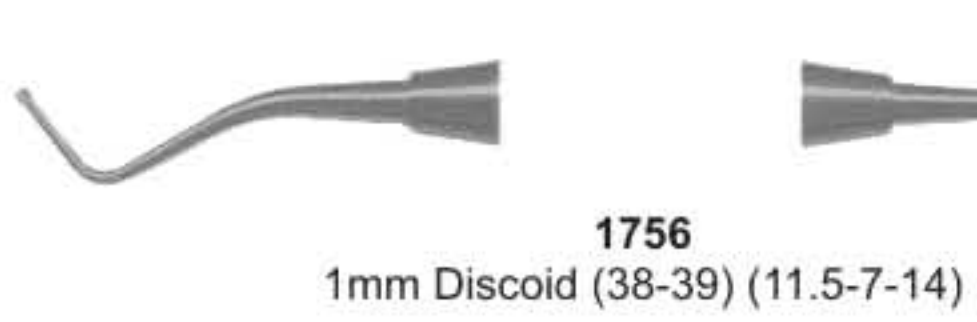



Excavators

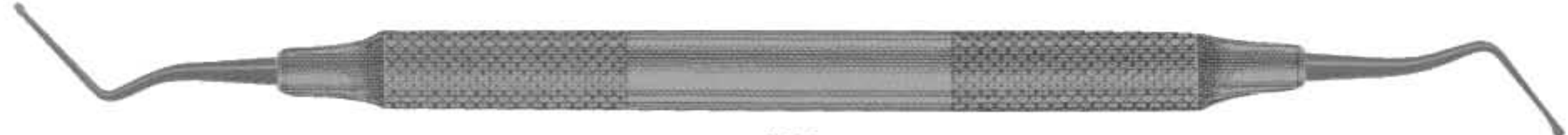

1768  
31L



1769  
31W



1770  
33L



1771  
32L



Explorers / Probes



1772  
G16D-L



1773  
Explorer No.2



1774  
Explorer No.16

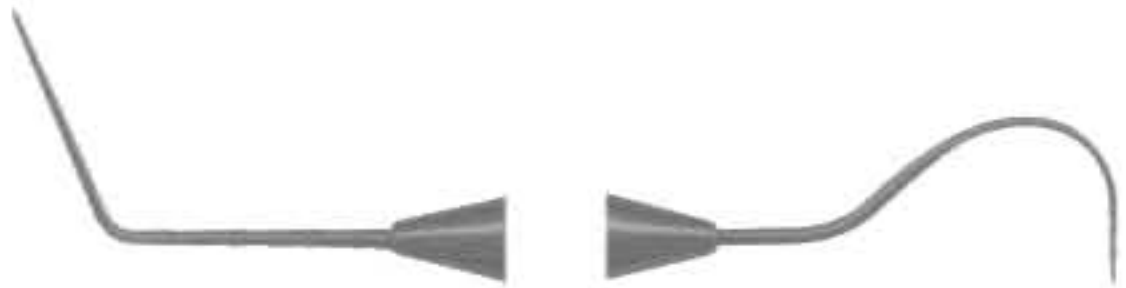

1775  
16-23 Explorer



1776  
16-17 Explorer



1777  
DG16 Explorer



1778  
(Heavy DG-16)



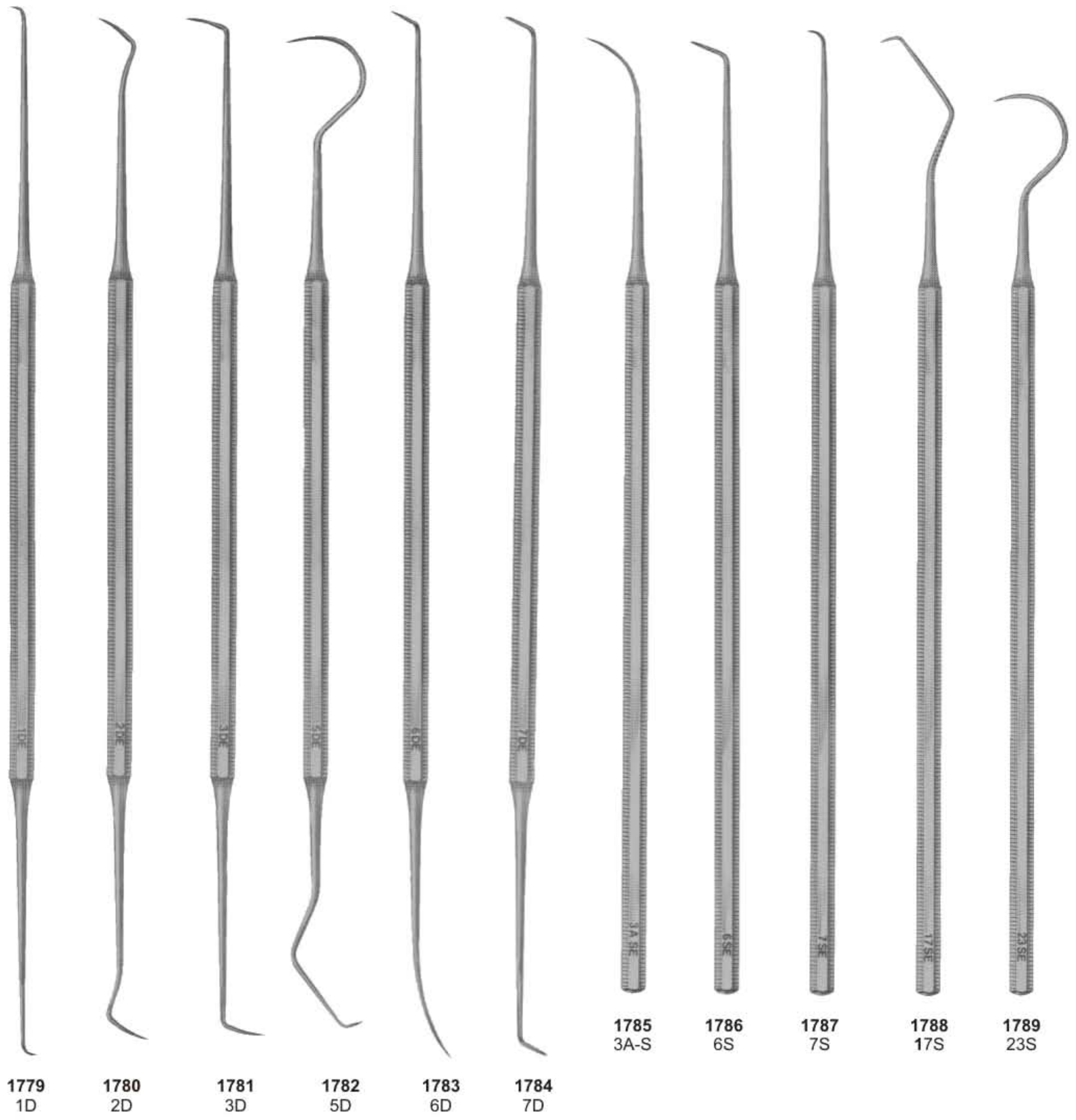

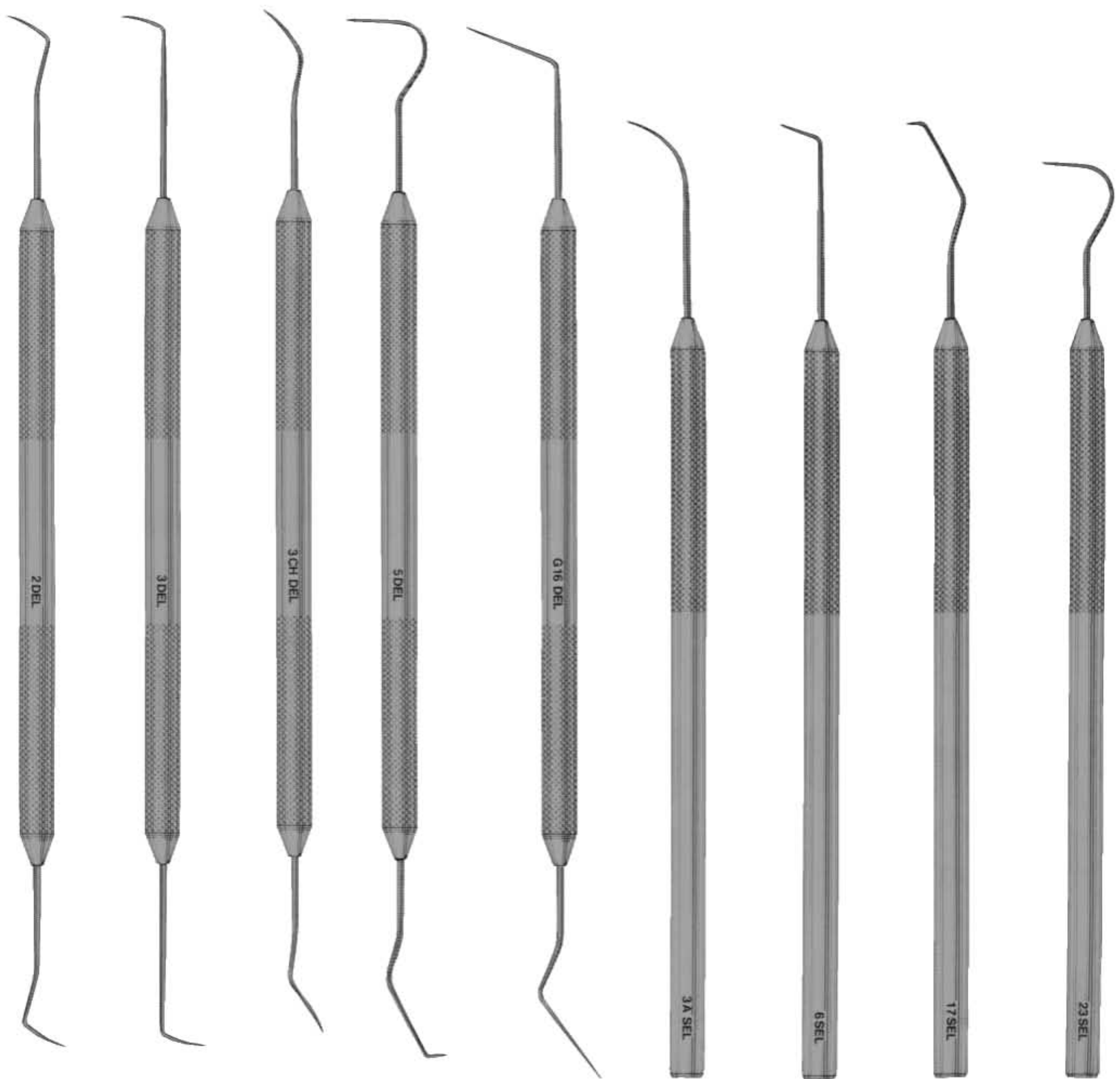

**1790**  
No. 2D-L

**1791**  
No. 3D-L

**1792**  
No. 3CHD-L

**1793**  
No. 5D-L

**1794**  
No. G16D-L

**1795**  
No. 3AS-L

**1796**  
No. 6S-L

**1797**  
No. 17S-L

**1798**  
No. 23S-L

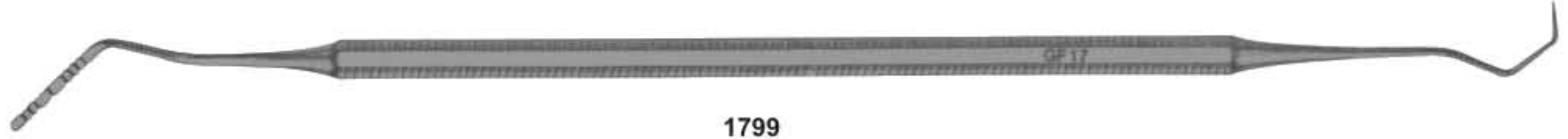

**1799**  
Gf17 Probe/Explorer



**1800**  
PE 1-23 Probe/Explorer

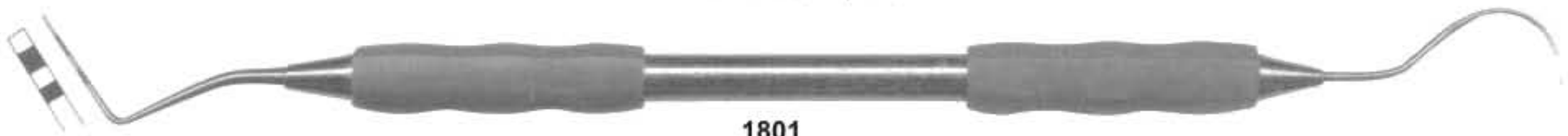

**1801**  
Probe 0 / 23 Explorer (fine)



**1802**  
Probe 1 / 23 Explorer



**1804**  
Probe 4 / 23 Explorer



**1803**  
Probe OW / 23 Explorer

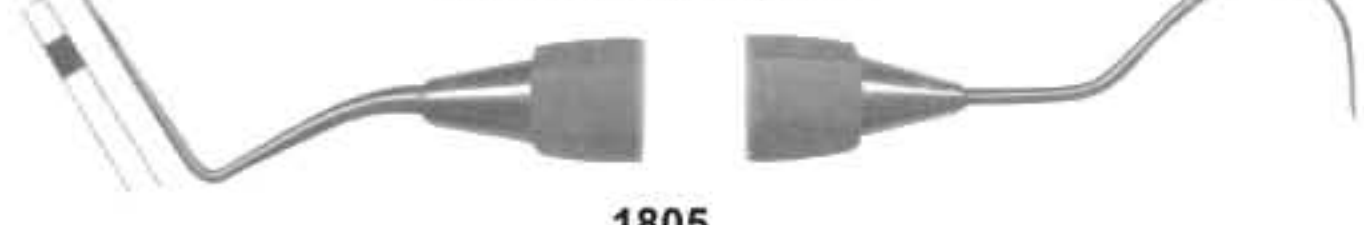

**1805**  
Ball Tip Probe WHO / 23 Explorer

**PROBES**

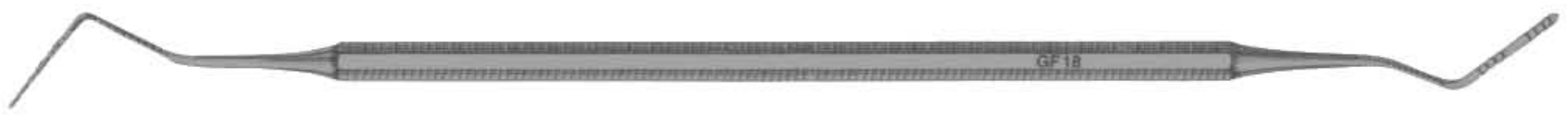

**1806**  
Gf18 Probe



**1807**  
"C" Probe



**1808**  
X2 Probe

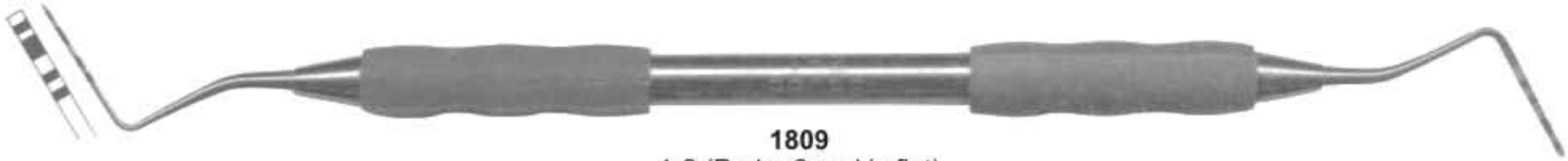

**1809**  
1-2 (Probe 2 end is flat)



**1810**  
1 UNC 15

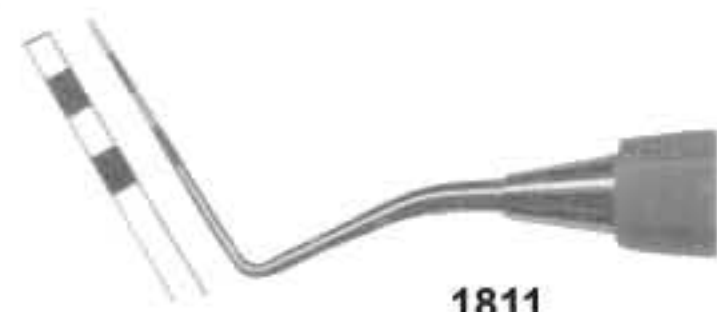

**1811**  
4 SE

CORD PACKERS



1812

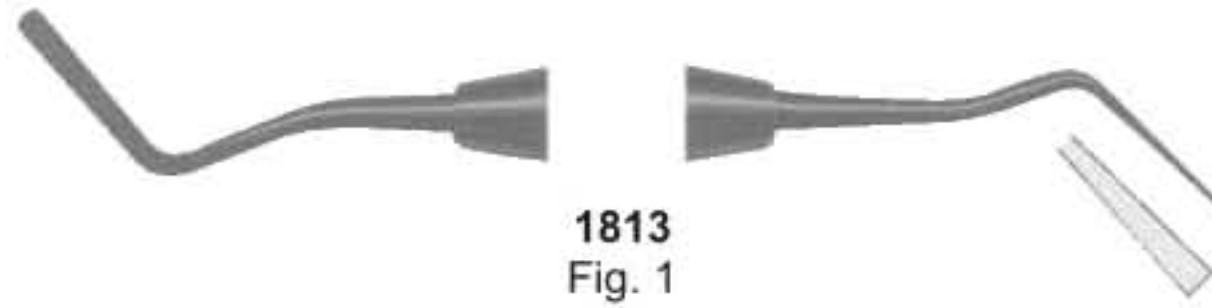

1813  
Fig. 1



1814  
Fig. 2



1815  
BLOOMFIELD  
Fig. 2 (off angle)



1816  
Fig. 1



1817  
CSI-1 (slightly serrated on ends)



HATCHETS



1818  
1mm (10-7-14)



1819  
1.3mm (13-10-16)



1820  
1.5mm (15-8-14)



HOES

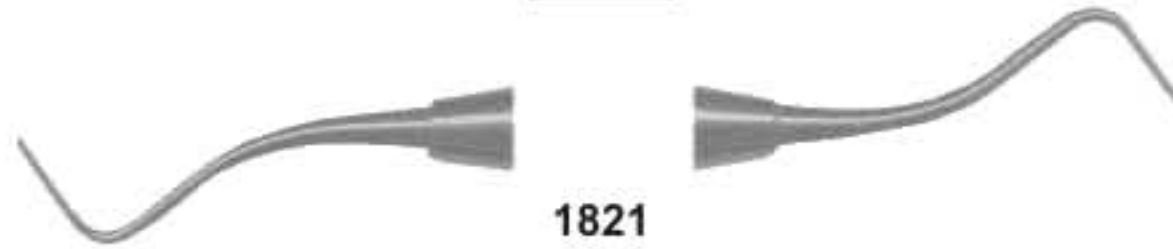

1821  
1mm (10-8-16)



1822  
UWH 18-19



1823  
UWH 16-18



1824  
UWH 20-21



**1825**  
P.K.Thomas 1



**1826**  
P.K.Thomas 2



**1827**  
P.K.Thomas 3



**1828**  
P.K.Thomas 4



**1829**  
P.K.Thomas 5



**7001**  
Gracey Currettes Set of 7 Pcs, Silicon Handle - Reuseable



**1830**  
BEHRMAN (Fig. 1)



**1831**  
BLACK (Fig. 1-2)



**1832**  
MORQUETTE (Fig. 0/1)



**1833**  
Black Action 11/12 Plugger



**1834**  
Hollenback No.1 Plugger



**1835**  
Hollenback No. 2 Plugger



**1836**  
Hollenback No. 3 Plugger



**1837**  
Blacks 0-1 (1mm-1.5mm)



**1838**  
Blacks 1-2 (1.5mm-2.5mm)



**1839**  
Bodkin 1 (.7mm-1mm)



**1840**  
Bodkin 2 (1.5mm-2mm)

**1843**  
.7mm-1mm



**1844**  
1mm-1.5mm



**1845**  
1.5mm-2mm



**1846**  
Oregon (Fig. 3)



**1847**  
Oregon (Fig. 4)



**1848**  
UP 12



**1849**  
Applicator 1-2



**1850**  
Birtles Applicator Spatula



**1851**  
Birtles Applicator Spatula K

**Placement Instruments**



**1852**  
PICH (Calcium Hydroxide Placer)



**1853**  
CA

**Stopping Stoppers**



**1854**  
Woodson 2



**1855**  
Woodson 3S



**1856**  
Woodson 3A



**1857**  
Woodson 3

**Pluggers**



**1858**  
Pluggers 0-1



**1859**  
Pluggers 1-4

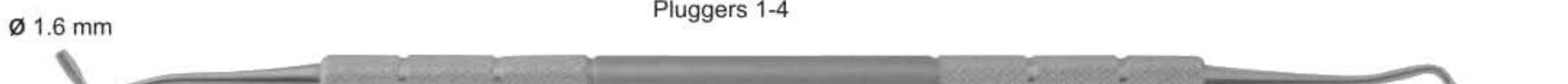

**1860**  
Pluggers 4-6



**1861**  
Pluggers 6-8



**1862**  
Black 1-2



**1863**  
Black 2-3



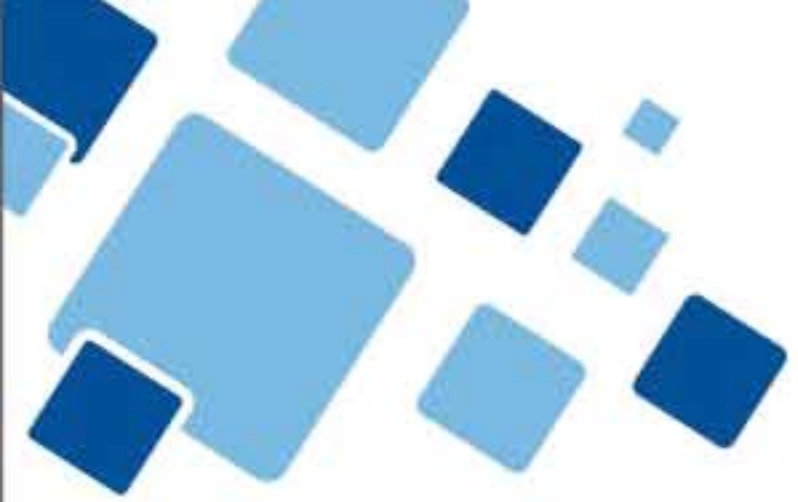

- ⟨🦷⟩ Burnishers
- ⟨🦷⟩ Carvers
- ⟨🦷⟩ Chisels
- ⟨🦷⟩ Composite Placements
- ⟨🦷⟩ Filling Instruments
- ⟨🦷⟩ Curettes
- ⟨🦷⟩ Disposable Instruments

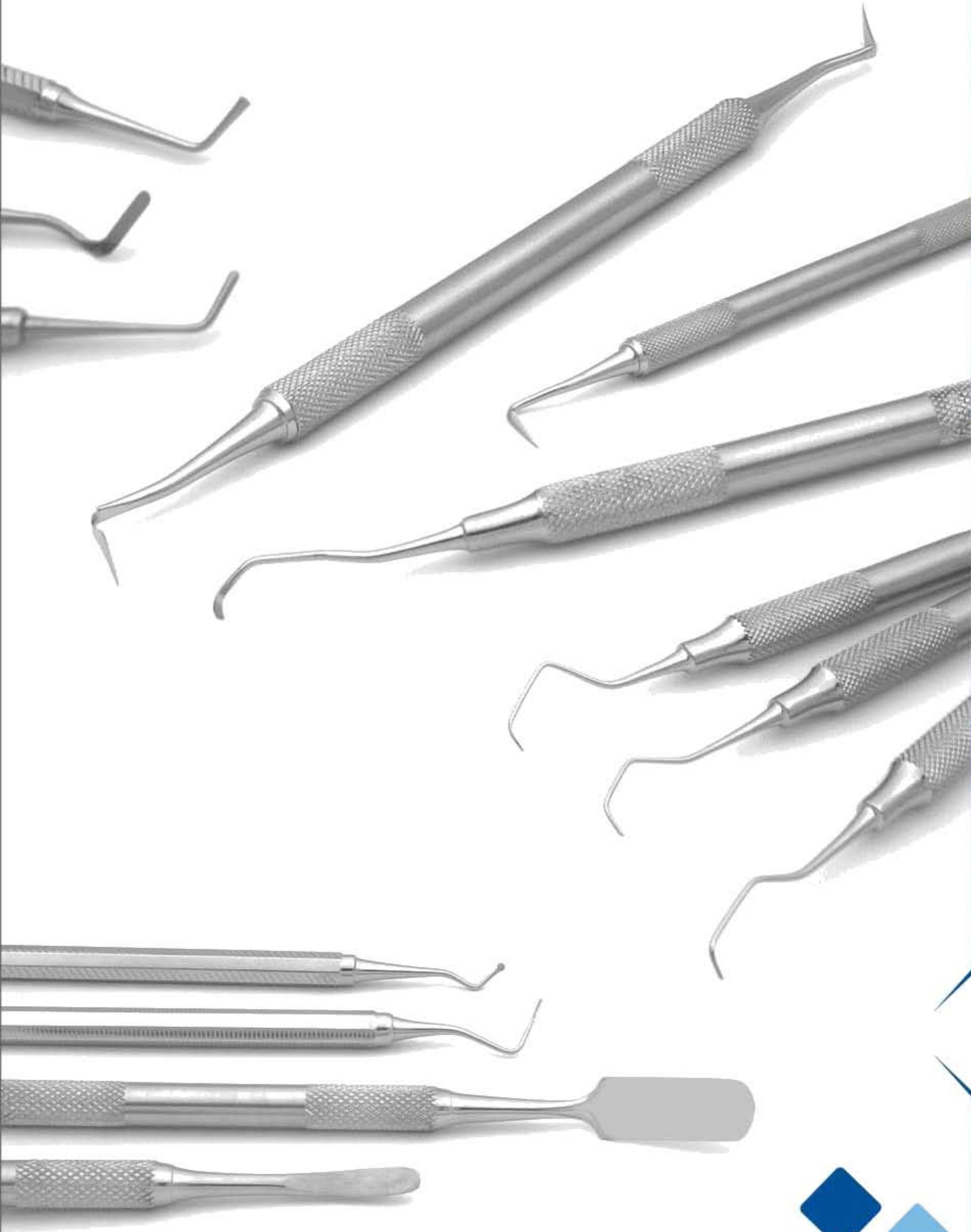

# 03

SECTION



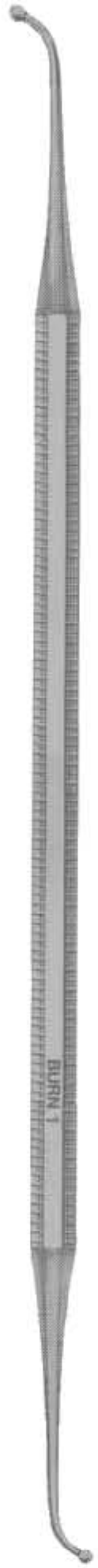

**1864**  
Fig. 1

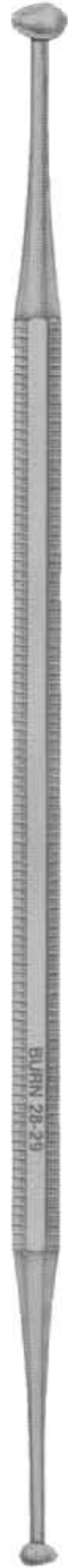

**1865**  
Fig. 28/29



**1866**  
Fig. 34

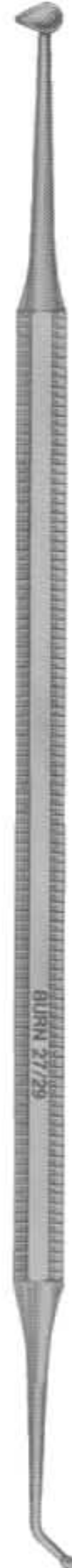

**1867**  
Fig. 27/29

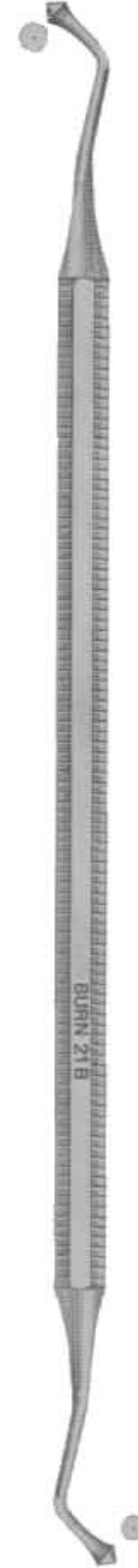

**1868**  
Fig. 21B

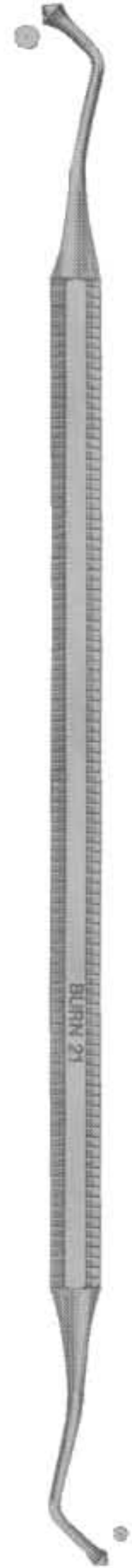

**1869**  
ACORN  
Fig. 21

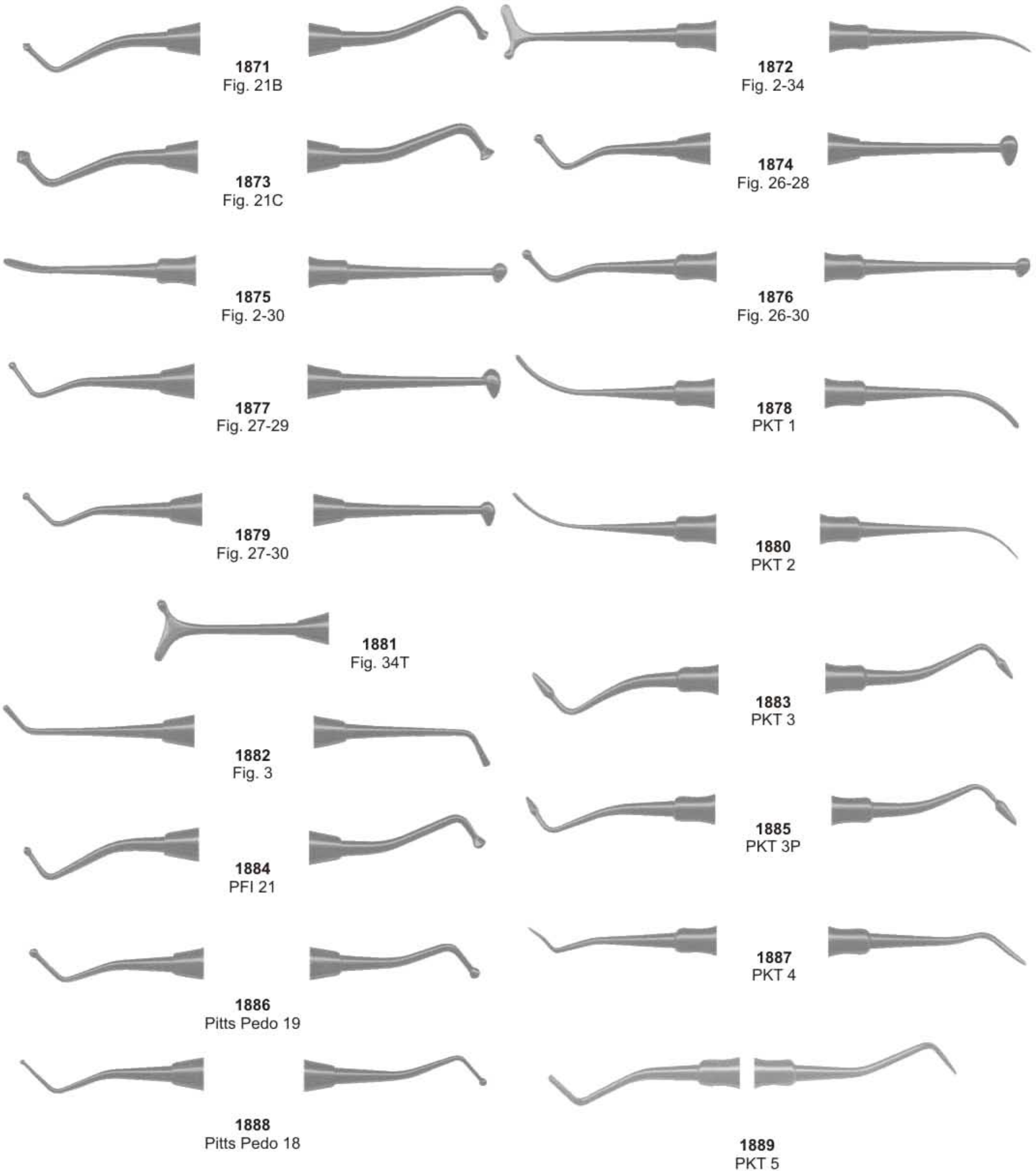

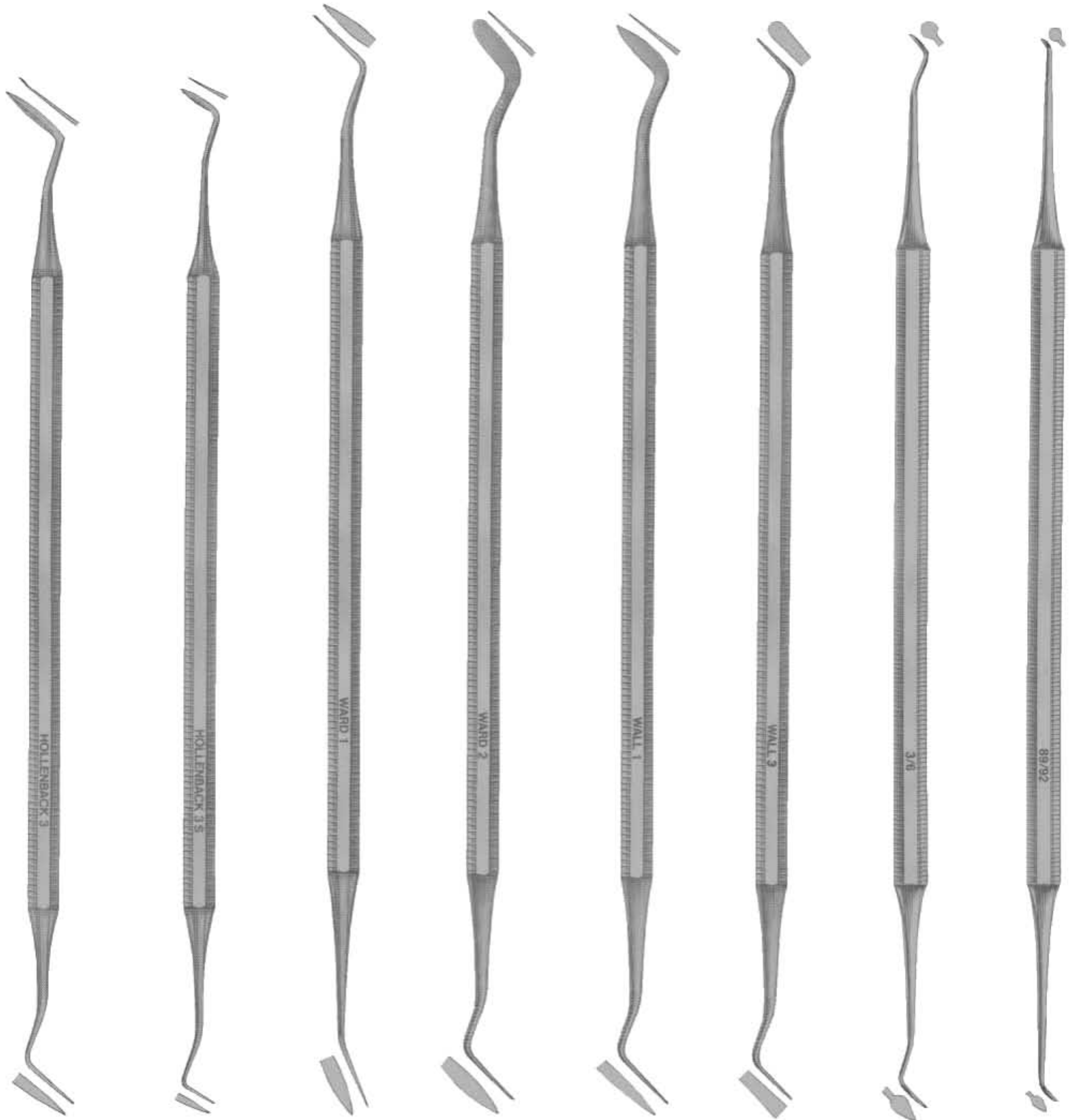

**1890**  
HOLLENBACK  
Fig. 3

**1891**  
HOLLENBACK  
Fig. 3S

**1892**  
WARD  
Fig. 1

**1893**  
WARD  
Fig. 2

**1894**  
WALL  
Fig. 1

**1895**  
WALL  
Fig. 3

**1896**  
Fig. 3/6  
Cleoid/Discoïd

**1897**  
Fig. 89/92  
Cleoid/Discoïd



**1898**  
1.5mm Cleoid Discoid (Shown with GTX Finish)



**1899**  
2mm Cleoid Discoid



**1900**  
GOLLOBIN  
Fig. 1



**1901**  
3mm Cleoid Discoid



**1902**  
HOLLENBACK  
Fig. 1/2



**1903**  
FRAHM  
Fig. 2-3 (off-angle)



**1904**  
HOLLENBACK  
Fig. 3



**1905**  
Interproximal 1



**1906**  
THOMPSON (Fig. 3)  
(½ Hollenback Hoe & Wall 3)



**1907**  
Interproximal 1



**1908**  
THOMPSON (Fig. 5)  
(½ Hollenback Hoe & Tanner 5)



**1909**  
Baum Interproximal



**1910**  
THOMPSON (Fig. 8)  
(3mm Cleoid & Wall 3)



**1911**  
Sho A Carver



**1912**  
THOMPSON (Fig. 9)  
(Hollenback 3 & Wall 3)



**1913**  
Thompson 2



**1914**  
WARD  
Fig. 2



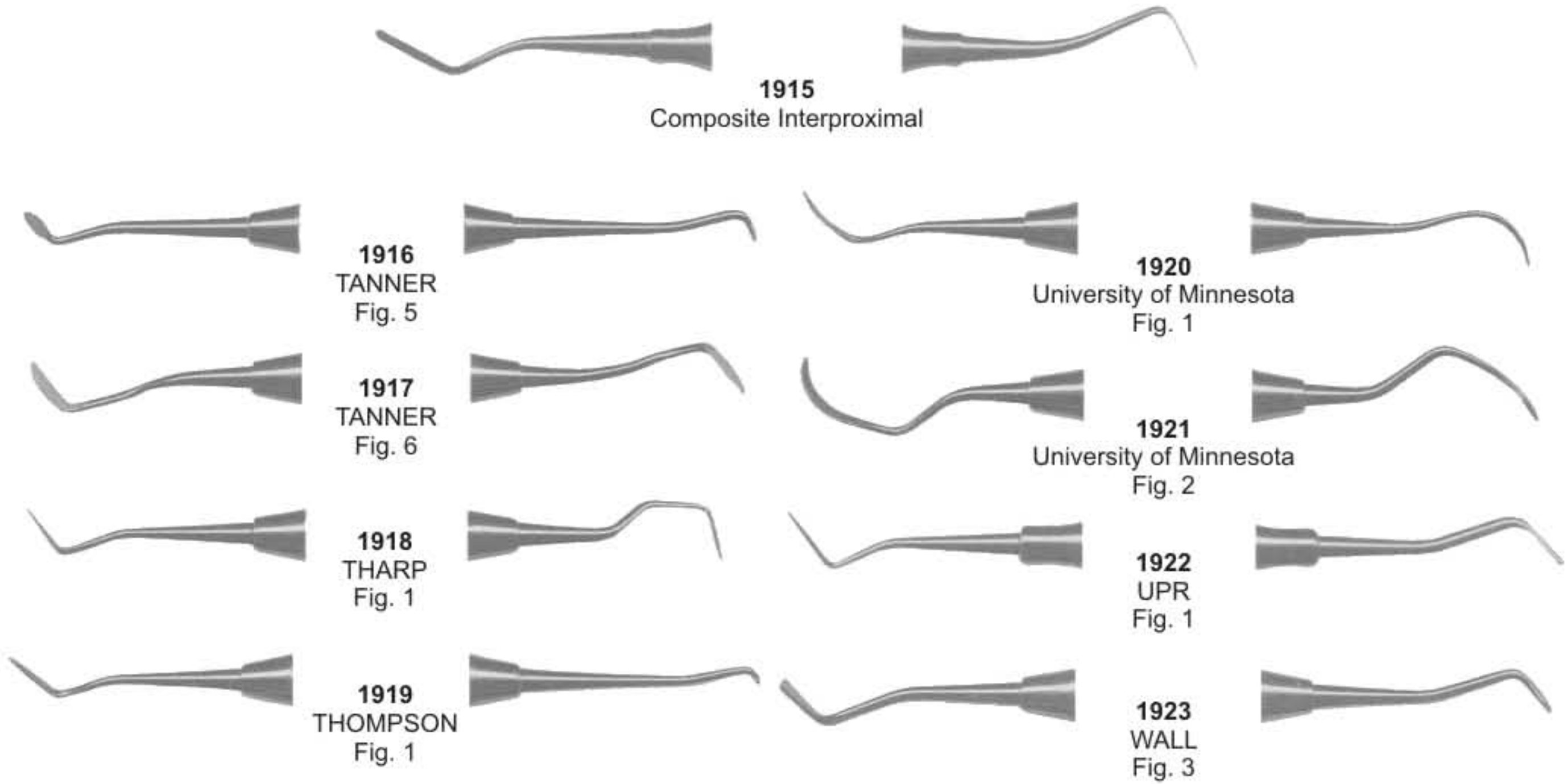

## Contour Carbide Carvers - Finishing

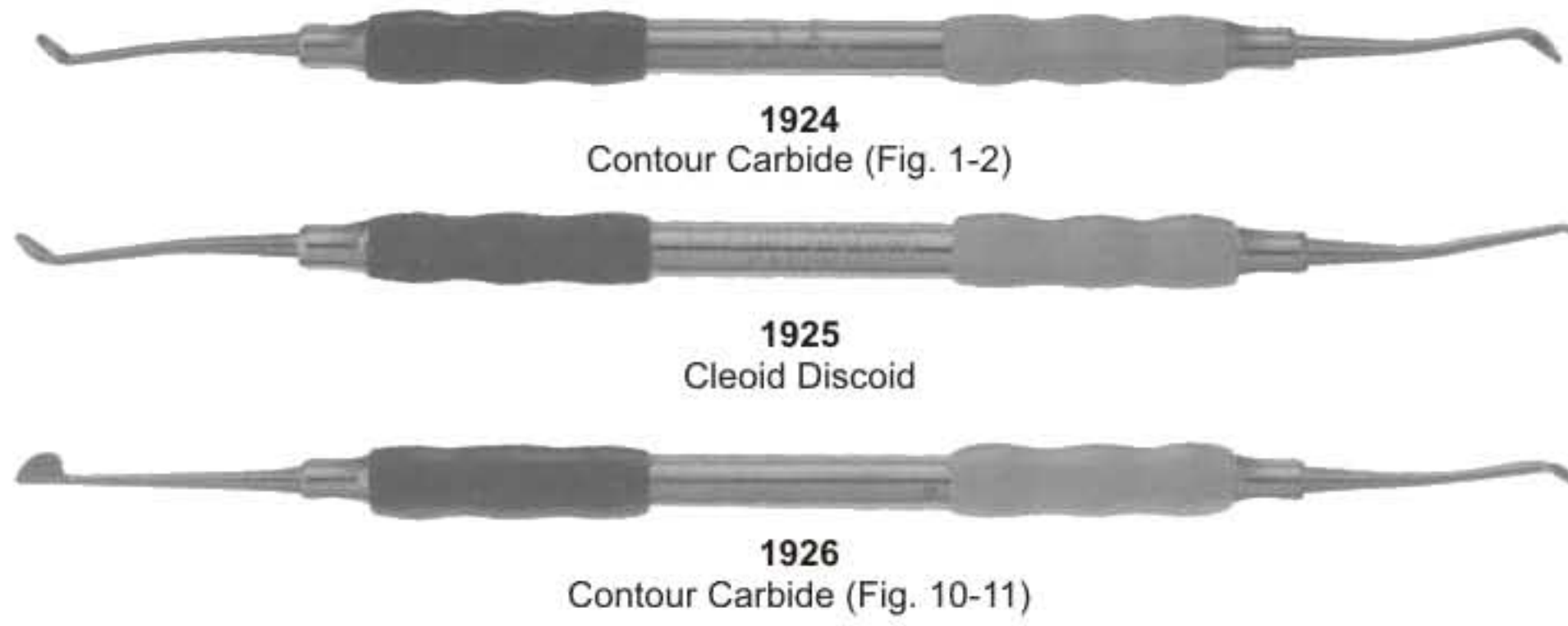

## Chisels

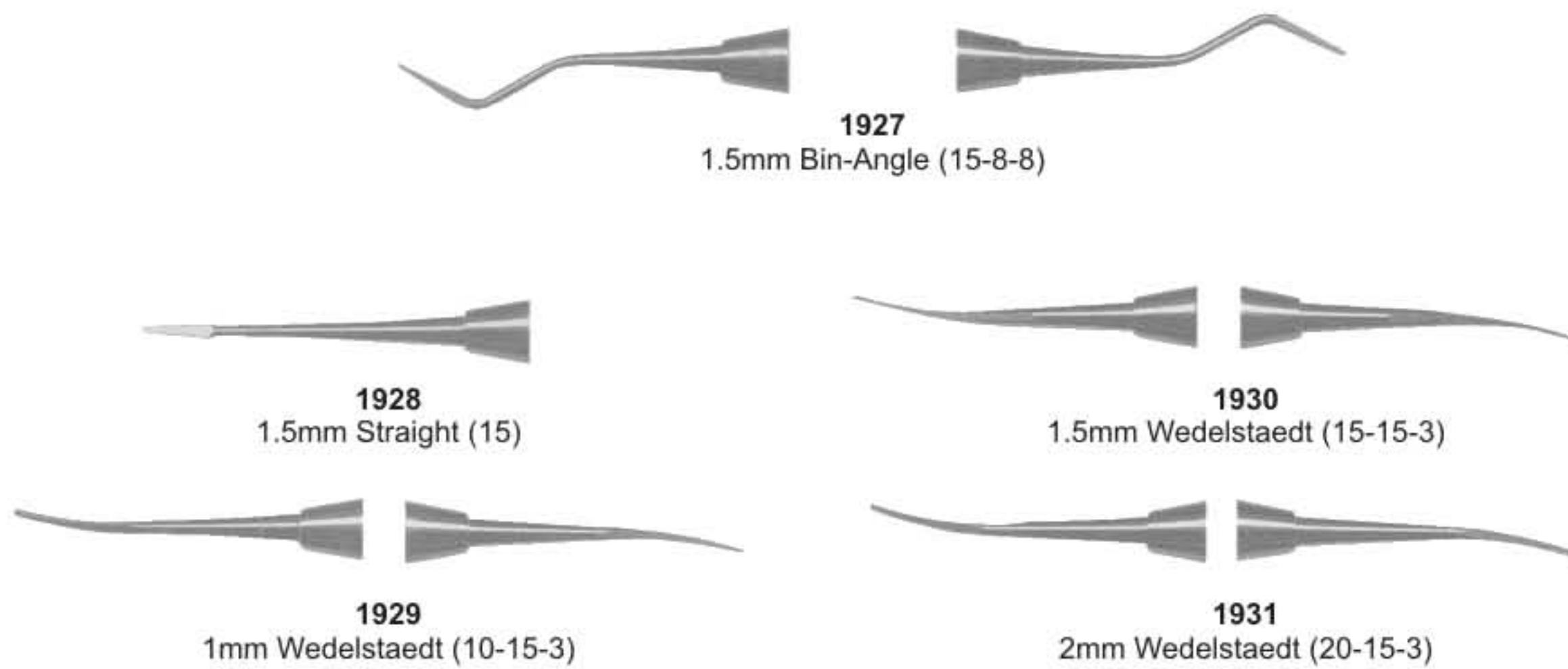

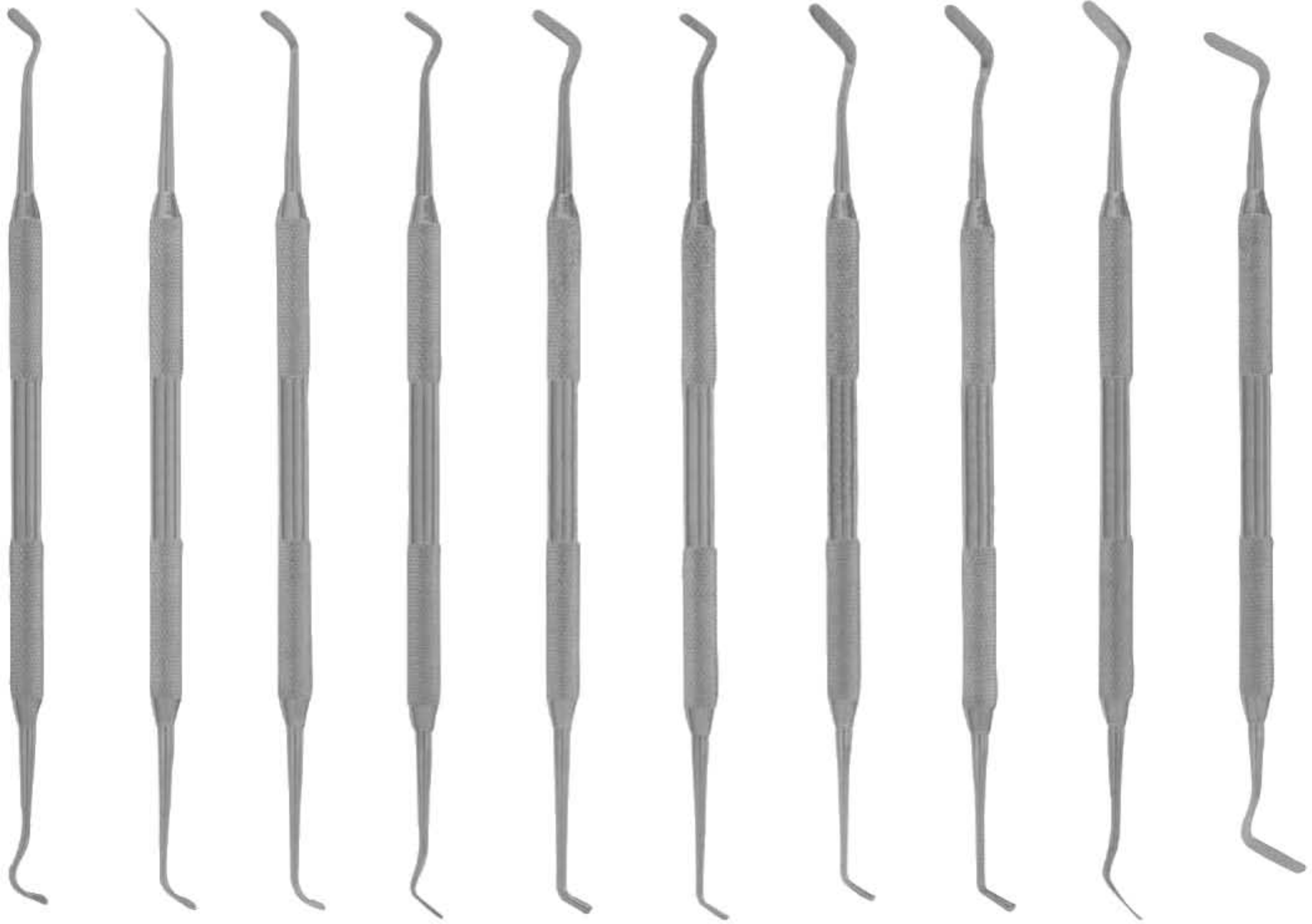

1932  
F-Type 1

1933  
F-Type 2

1934  
F-Type 3

1935  
F-Type 4

1936  
F-Type 5

1937  
F-Type 6

1938  
G-Type 1

1939  
G-Type 2

1940  
G-Type 3

1941  
G-Type 4

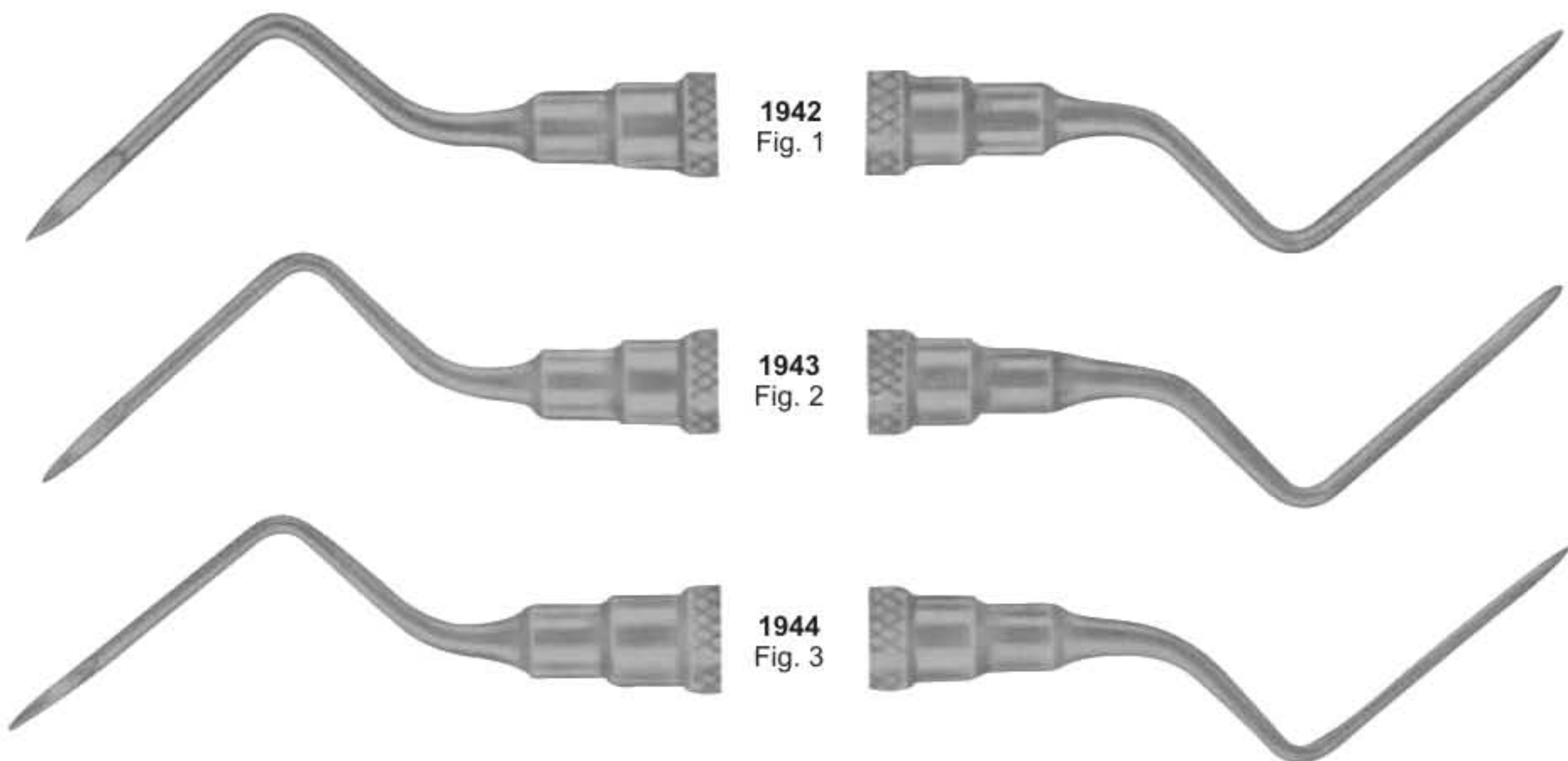

1942  
Fig. 1

1943  
Fig. 2

1944  
Fig. 3



1945  
Fig. 2



1946  
Fig. 3 (off-set blade)



1954  
Fig.12



1947  
Fig. 4



1955  
Fig.15



1948  
Fig. 5



1956  
JORDAN  
Fig. 2



1949  
Fig. 6



1957  
FREEDMAN  
Fig. 1



1950  
Fig.7



1958  
FREEDMAN  
Fig. 2



1951  
Fig.8



1959  
FREEDMAN  
Fig. 3



1952  
Fig.9



1960  
Dr. Dan



1953  
Fig.11



1961  
SIMON  
Fig. 2



## K - Type

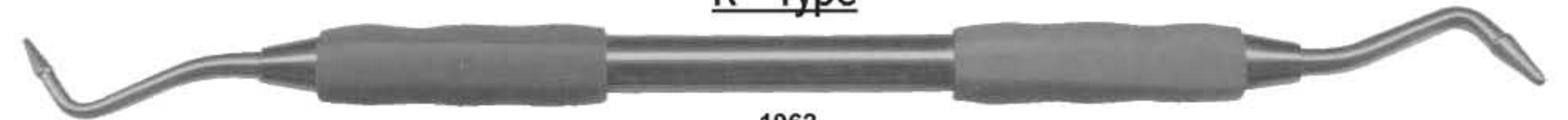

1962  
K-Type 1



1963  
K-Type 2



1965  
K-Type 4



1964  
K-Type 3



1966  
K-Type 5



1967  
K-Type 6 Carbide



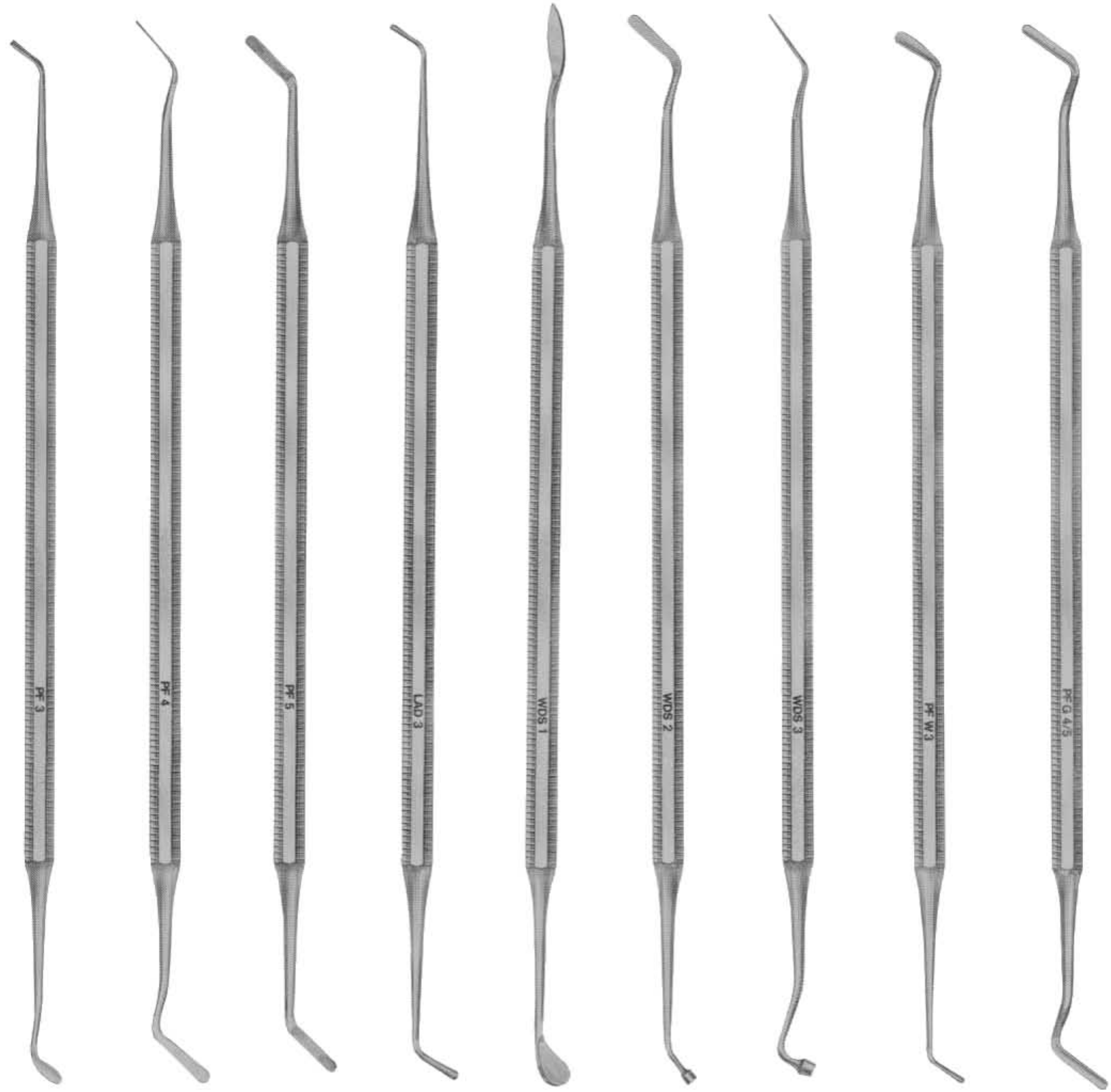

|                     |                     |                     |                                  |                                  |                                  |                                  |                    |                             |
|---------------------|---------------------|---------------------|----------------------------------|----------------------------------|----------------------------------|----------------------------------|--------------------|-----------------------------|
| <b>1968</b><br>No.3 | <b>1969</b><br>No.4 | <b>1970</b><br>No.5 | <b>1971</b><br>LADMORE<br>Fig. 3 | <b>1972</b><br>WOODSON<br>Fig. 1 | <b>1973</b><br>WOODSON<br>Fig. 2 | <b>1974</b><br>WOODSON<br>Fig. 3 | <b>1975</b><br>W-3 | <b>1976</b><br>Gregg<br>4/5 |
|---------------------|---------------------|---------------------|----------------------------------|----------------------------------|----------------------------------|----------------------------------|--------------------|-----------------------------|



1977  
Fig. 5-7



1978  
Fig.1



1979  
Fig. 3



1983  
GLICK  
Fig.1



1980  
Fig. 4



1984  
P8



1981  
Fig. 5-7



1985  
WOODSON  
Fig. 1



1982  
Fig. 8A



1986  
WOODSON  
Fig. 2



1987  
WOODSON  
Fig. 3





**1988**  
GRACEY  
GC 1-2



**1989**  
GRACEY  
GC 3-4



**1990**  
GRACEY  
GC 5-6



**1991**  
GRACEY  
GC 7-8



**1992**  
GRACEY  
GC 9-10



**1993**  
GRACEY  
GC 11-12



**1994**  
GRACEY  
GC 13-14

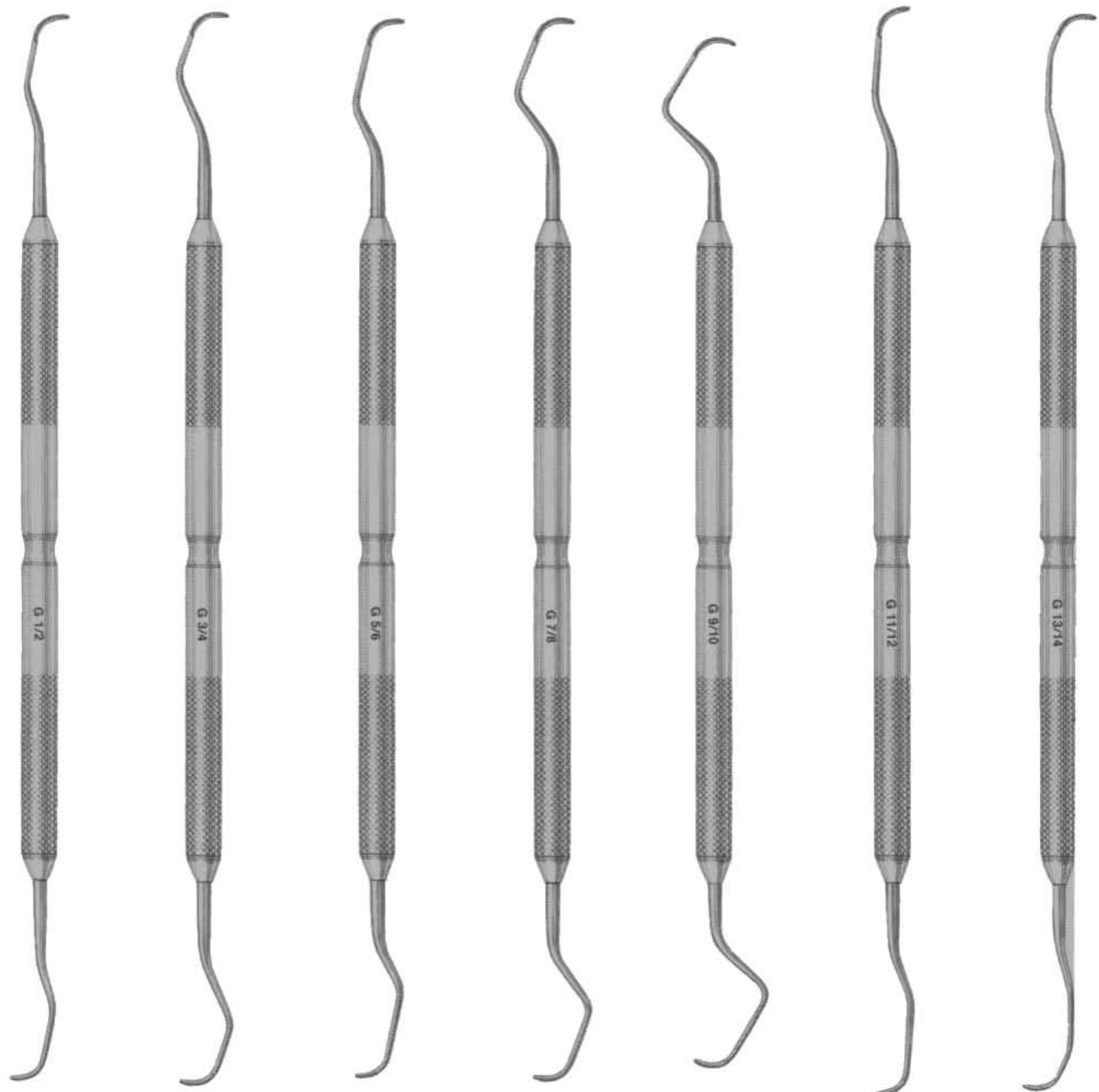

**1995**  
G1-2

**1996**  
G3-4

**1997**  
G5-6

**1998**  
G7-8

**1999**  
G9-10

**2000**  
G11-12

**2001**  
G13-14



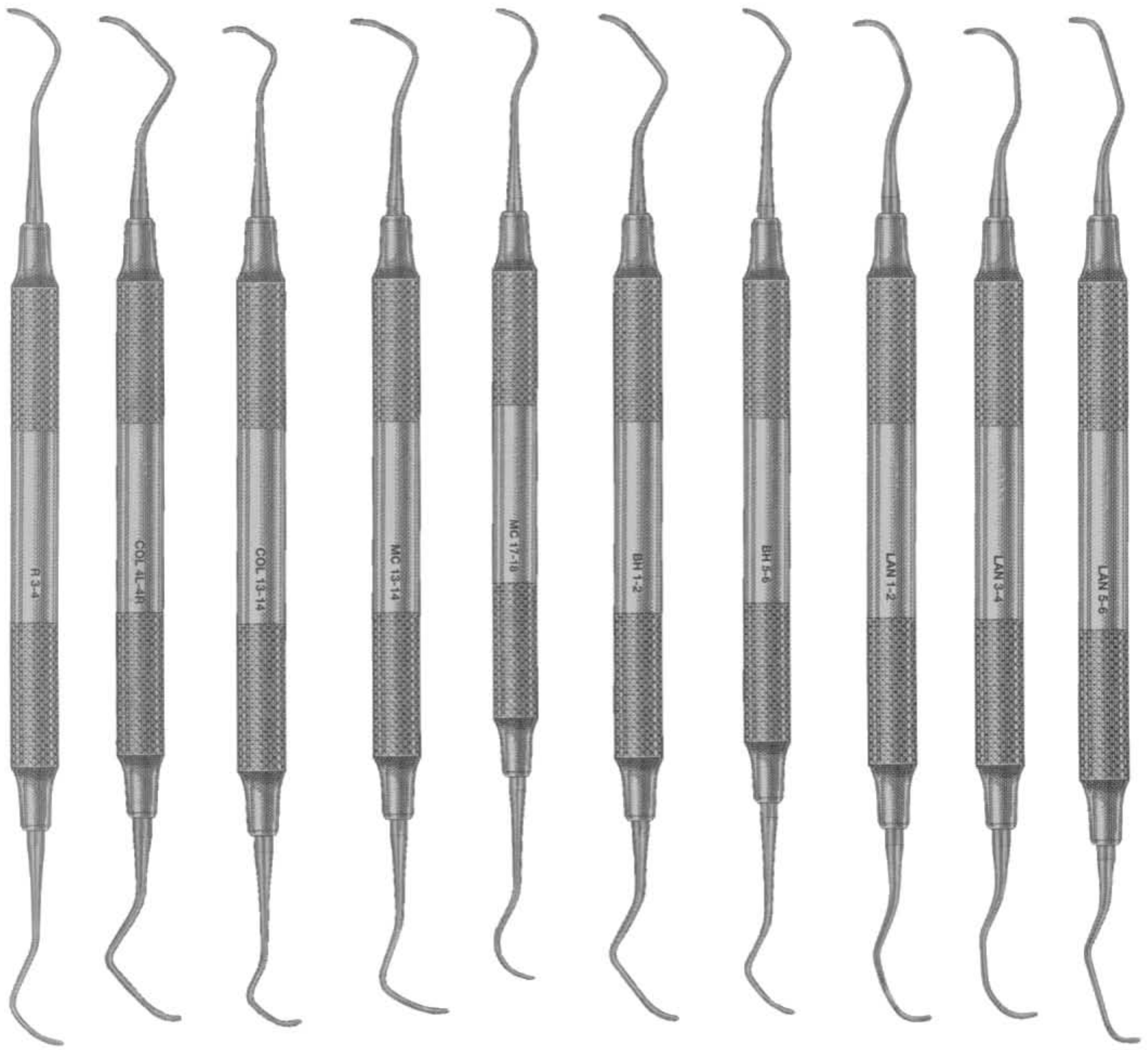

|                            |                                  |                                  |                                 |                                 |                                |                                |                              |                              |                              |
|----------------------------|----------------------------------|----------------------------------|---------------------------------|---------------------------------|--------------------------------|--------------------------------|------------------------------|------------------------------|------------------------------|
| <b>2002</b><br>RULE<br>3-4 | <b>2003</b><br>COLUMBIA<br>4R-4L | <b>2004</b><br>COLUMBIA<br>13-14 | <b>2005</b><br>MCCALLS<br>13-14 | <b>2006</b><br>MCCALLS<br>17-18 | <b>2007</b><br>BARNHART<br>1-2 | <b>2008</b><br>BARNHART<br>5-6 | <b>2009</b><br>LANGER<br>1-2 | <b>2010</b><br>LANGER<br>3-4 | <b>2011</b><br>LANGER<br>5-6 |
|----------------------------|----------------------------------|----------------------------------|---------------------------------|---------------------------------|--------------------------------|--------------------------------|------------------------------|------------------------------|------------------------------|

COLUMBIA CURETTES



2012  
4L-4R

2013  
13-14

2014  
2L-2R

MCCALLS CURETTES



2015  
13-14

2016  
13S-14S

2017  
17-18

2018  
17S-18S

GOLDMAN FOX



**2019**  
GF1 Universal Scaler



**2020**  
GF2 Curette



**2021**  
GF3 Curette



**2022**  
GF4 Curette



**2023**  
GF5 Hoe



**2024**  
GF6 Hoe

GOLDMAN FOX



**2025**  
GF 7 Knife



**2026**  
GF 8 Spear Knife



**2027**  
GF 9 Knife Scaler



**2028**  
GF 11 Spear Knife



**2029**  
GF 21 Sharp Spoon /  
Small Scaler





**2030**  
Kirkland 15 / 16



**2031**  
Ordan 1 / 2



**2032**  
Buck 3 / 4

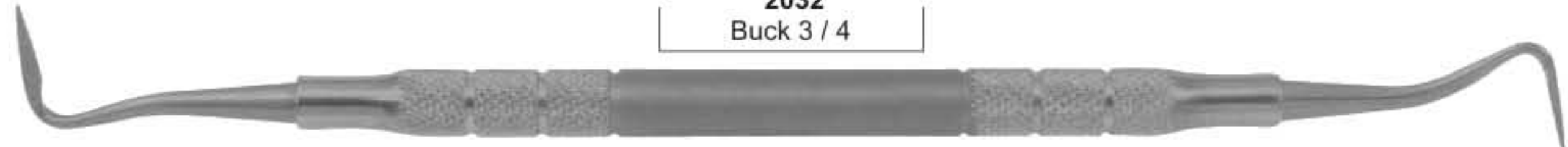

**2033**  
Buck 5 / 6



**2034**  
Goldman-Fox 7



**2035**  
Goldman-Fox 8



**2036**  
Goldman-Fox 9



**2037**  
Goldman-Fox 11



**2038**  
CK 3 (Crane)

## Interproximal Files

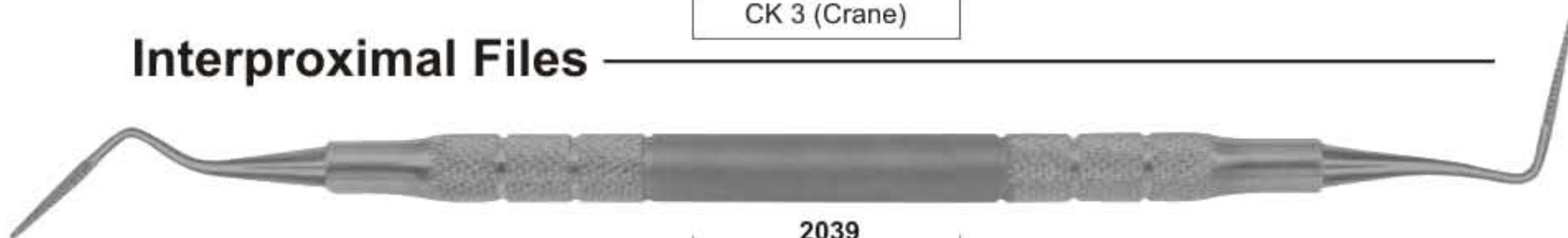

**2039**  
Sugarman 1S-2S

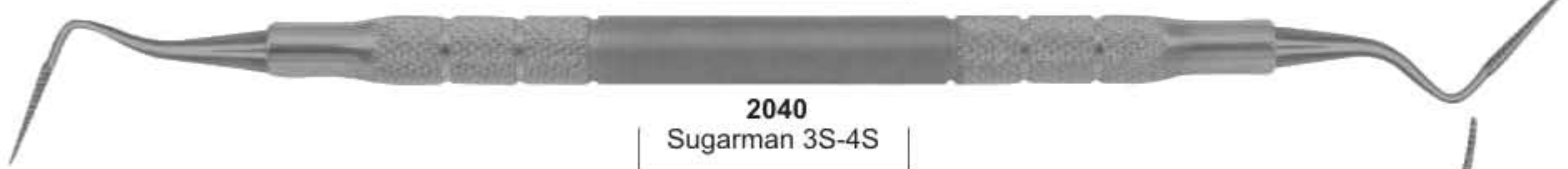

**2040**  
Sugarman 3S-4S



**2041**  
Schluger 9 -10



**2042**  
Buck 11 - 12



**2043**  
COLUMBIA (2L-2R)



**2044**  
MCCALL (13-14)



**2045**  
MCCALL (17S-18S)

### Root Planning Curettes



**2046**  
Root Plane (1-2)



**2047**  
Root Plane (5-6)



**2049**  
Root Plane (11-12)



**2048**  
Root Plane (7-8)

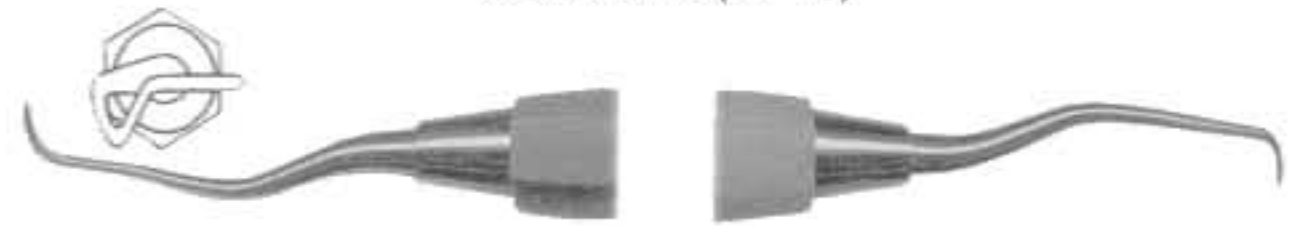

**2050**  
Root Plane (13-14)



**2051**  
Petite (1-2)

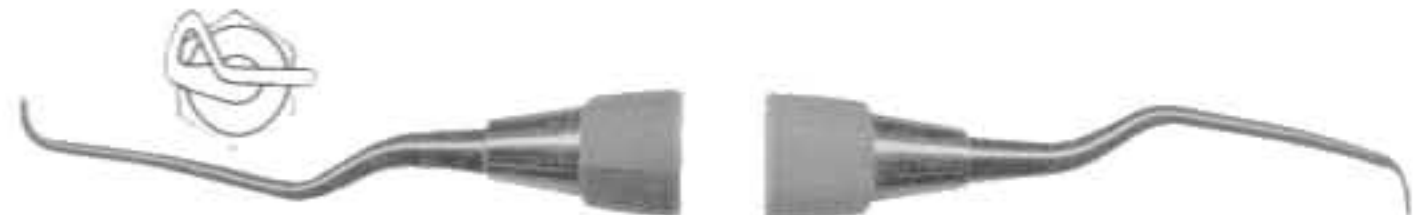

**2052**  
Petite (11-12)



**2053**  
Petite (5-6)



**2054**  
Petite (13-14)



2055  
BARNHART (1-2)



2056  
BARNHART (5-6)

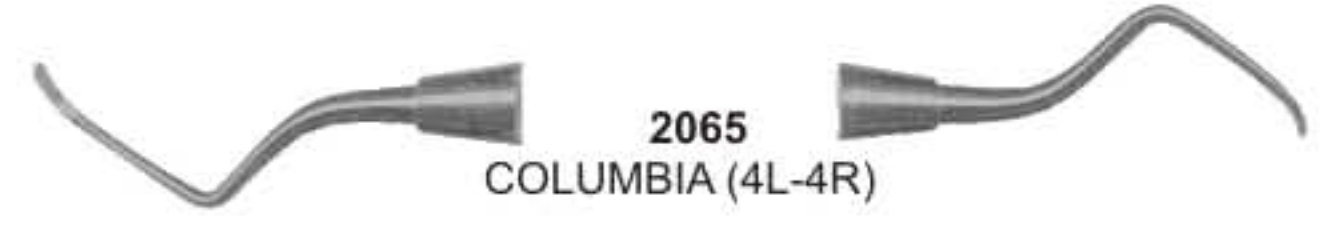

2065  
COLUMBIA (4L-4R)

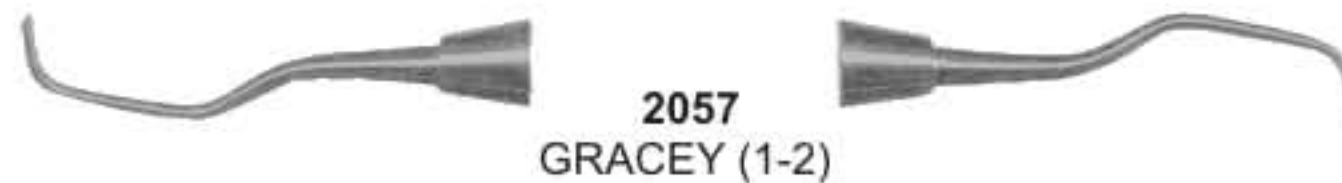

2057  
GRACEY (1-2)

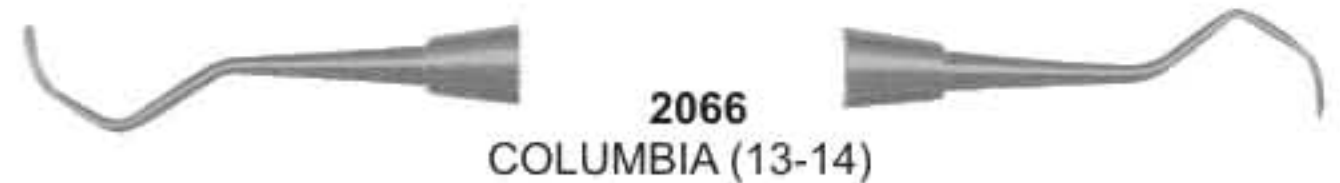

2066  
COLUMBIA (13-14)

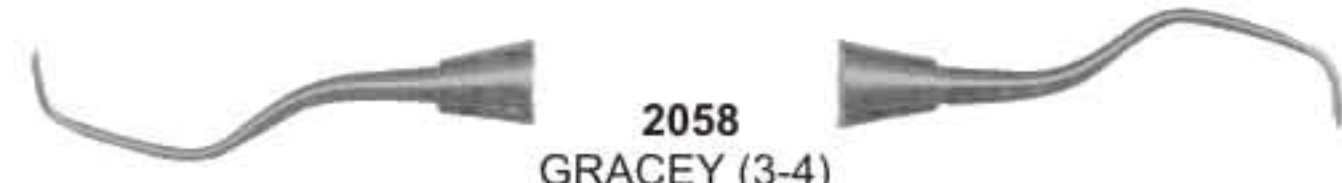

2058  
GRACEY (3-4)



2067  
LANGER (1-2)

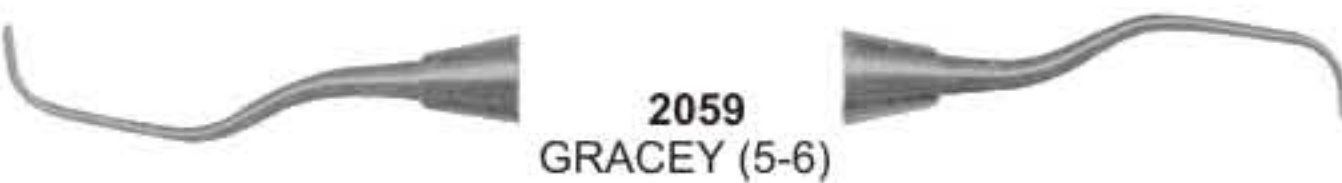

2059  
GRACEY (5-6)



2068  
LANGER (3-4)



2060  
GRACEY (7-8)



2069  
LANGER (5-6)



2061  
GRACEY (9-10)



2070  
MCCALL (13-14)



2062  
GRACEY (11-12)



2071  
MCCALL (13S-14S)

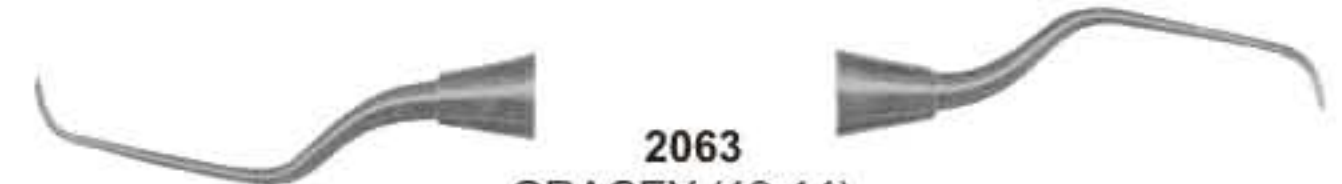

2063  
GRACEY (13-14)



2072  
MCCALL (17-18)

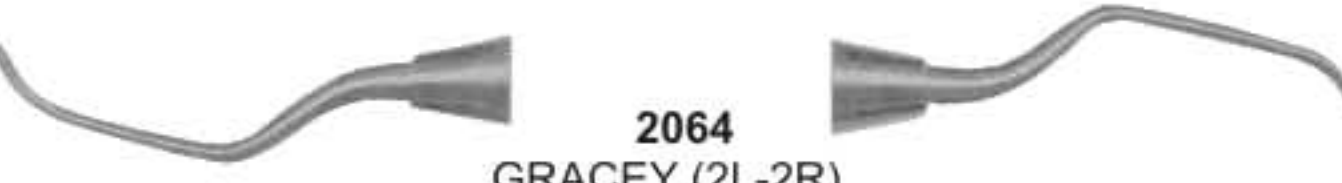

2064  
GRACEY (2L-2R)



2073  
MCCALL (17S-18S)



2074  
RULE (3-4)



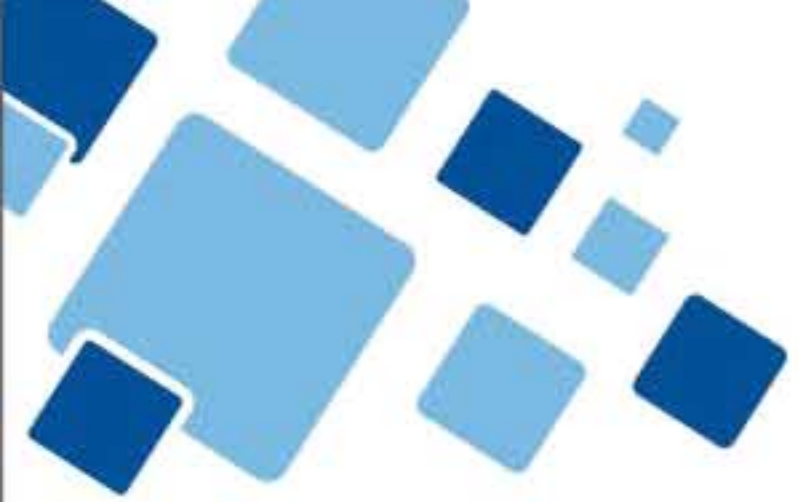

- ⟨🦷⟩ Cement Instruments
- ⟨🦷⟩ Bone Chisels
- ⟨🦷⟩ Spatulas
- ⟨🦷⟩ Bone Mallets
- ⟨🦷⟩ Knives
- ⟨🦷⟩ Crown Remover
- ⟨🦷⟩ Bone Currettes & Files
- ⟨🦷⟩ Implant Instruments



# 04

SECTION



Silicon Handles-Reusable

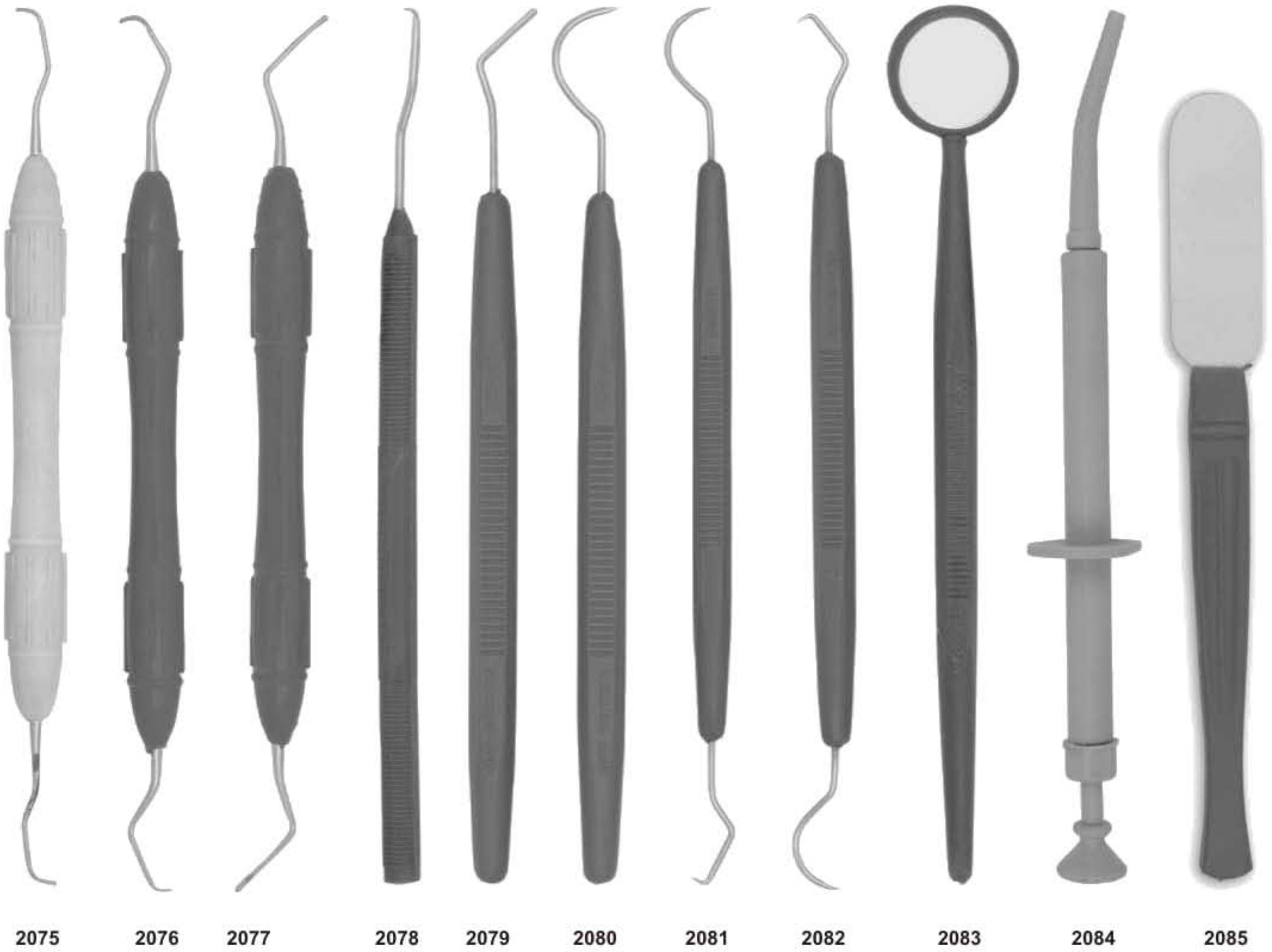

Comfort Grip  
Vinyl - Covered Insulating Handles

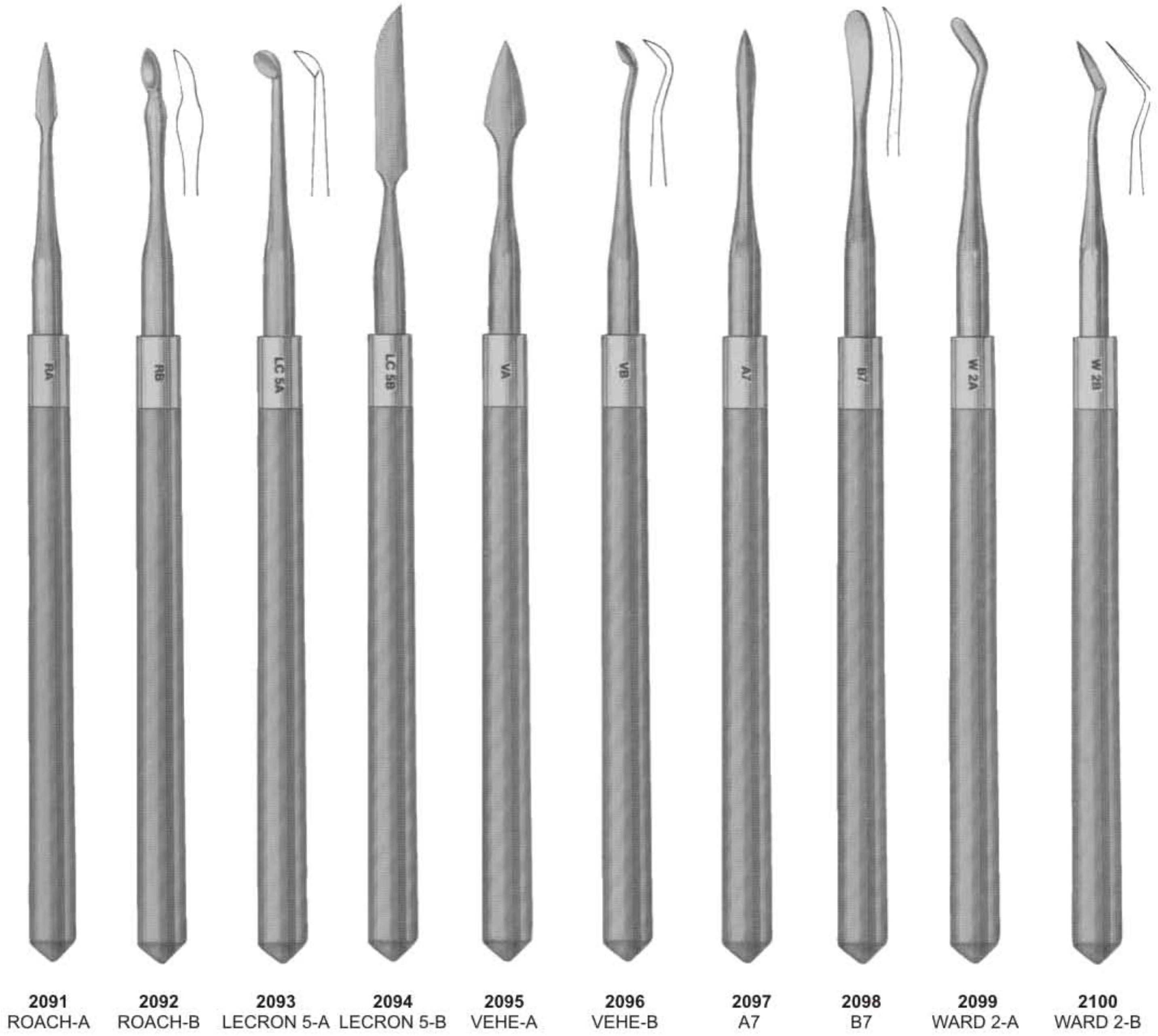

2091 ROACH-A    2092 ROACH-B    2093 LECRON 5-A    2094 LECRON 5-B    2095 VEHE-A    2096 VEHE-B    2097 A7    2098 B7    2099 WARD 2-A    2100 WARD 2-B

P.K. THOMAS



2101 PKT 1    2102 PKT 2    2103 PKT 3    2104 PKT 4    2105 PKT 5

Set of 5 instruments

WAX CARVERS

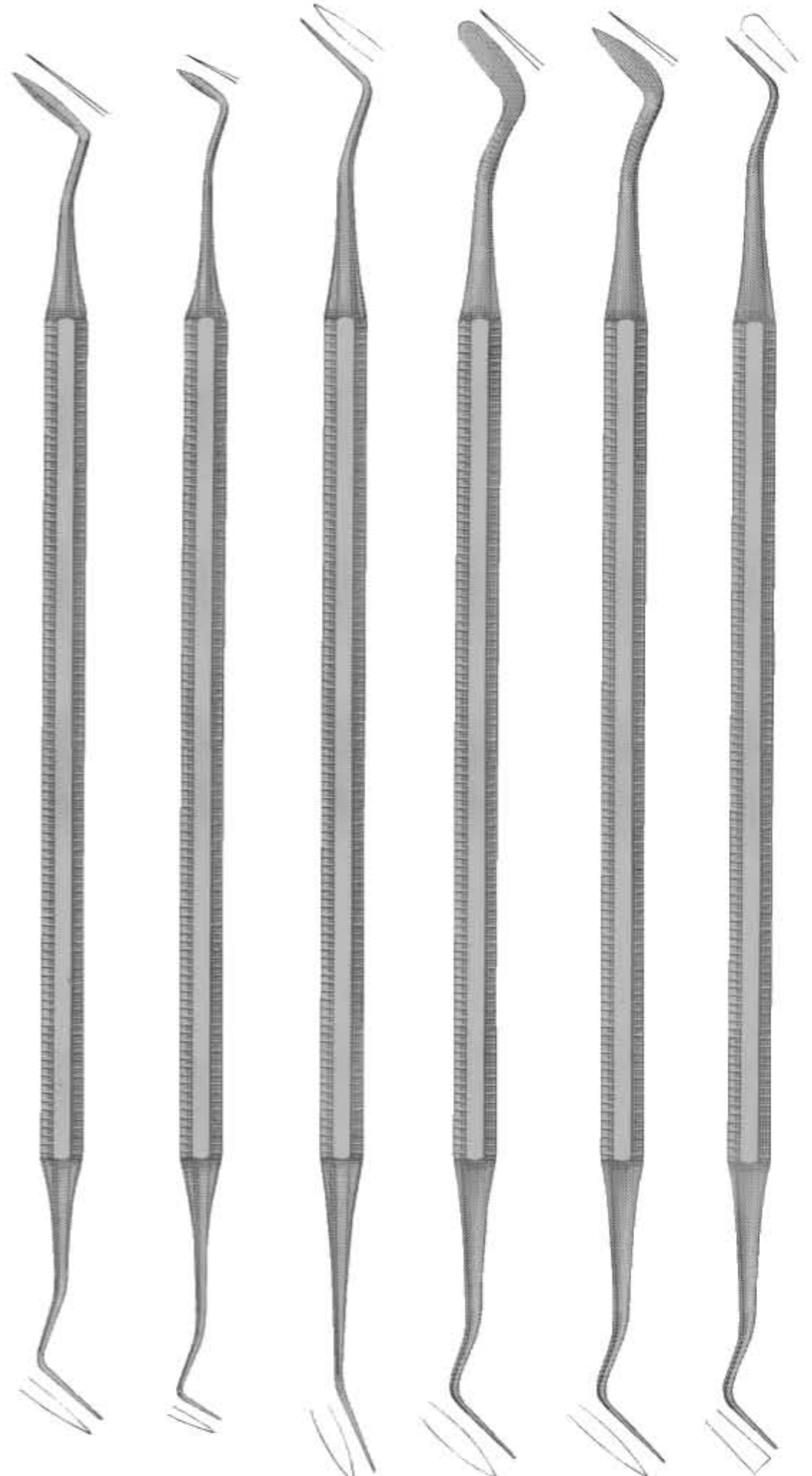

2106 Hollenback 3    2107 Hollenback 3S    2108 WARD 1    2109 WARD 2    2110 WALL 1    2111 WALL 3

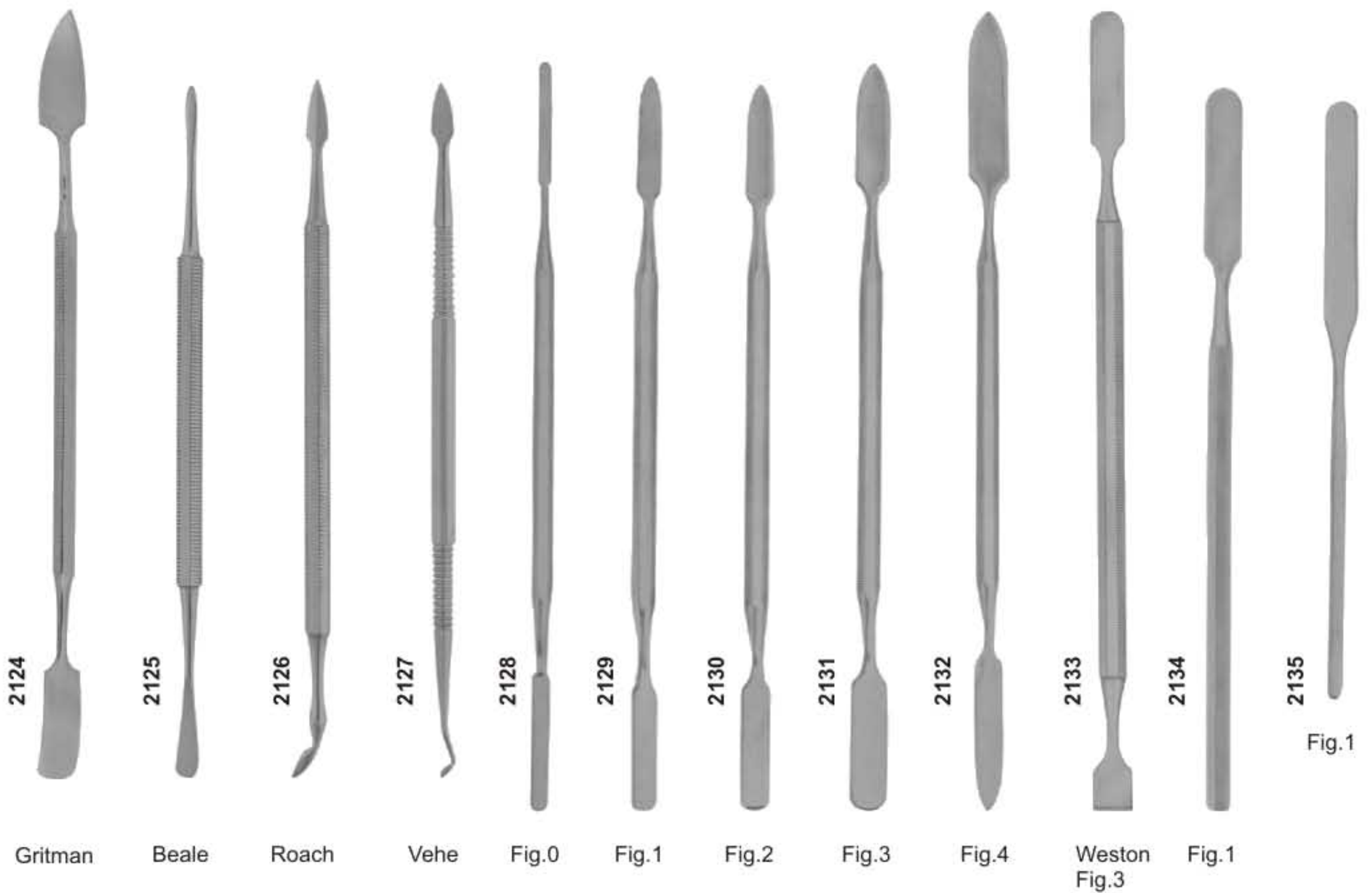
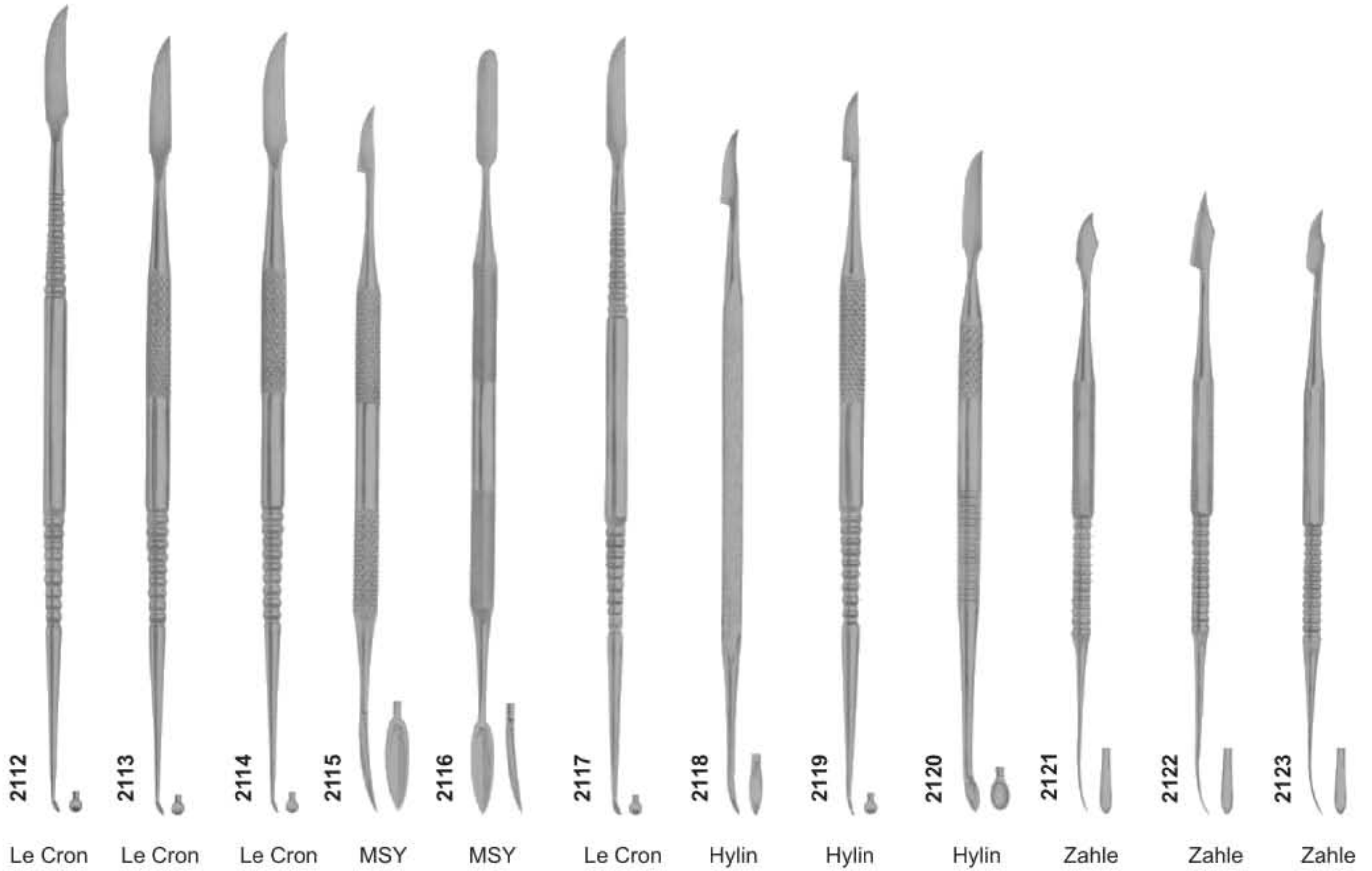



WAX & PORCELAINE CARVERS

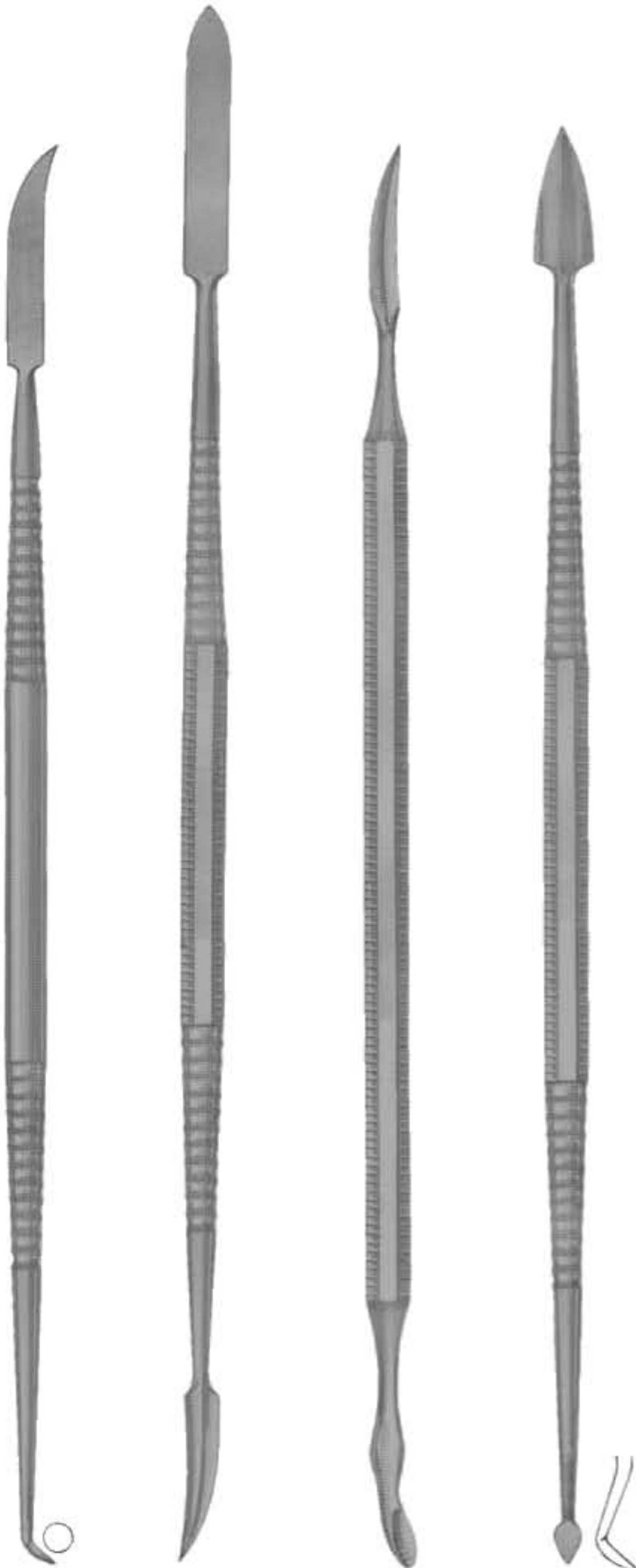

2136  
LECRON  
Inlay

2137  
REEVES

2138  
VEHE  
Wax

2139  
ROACH  
Wax

WAX SPATULAS

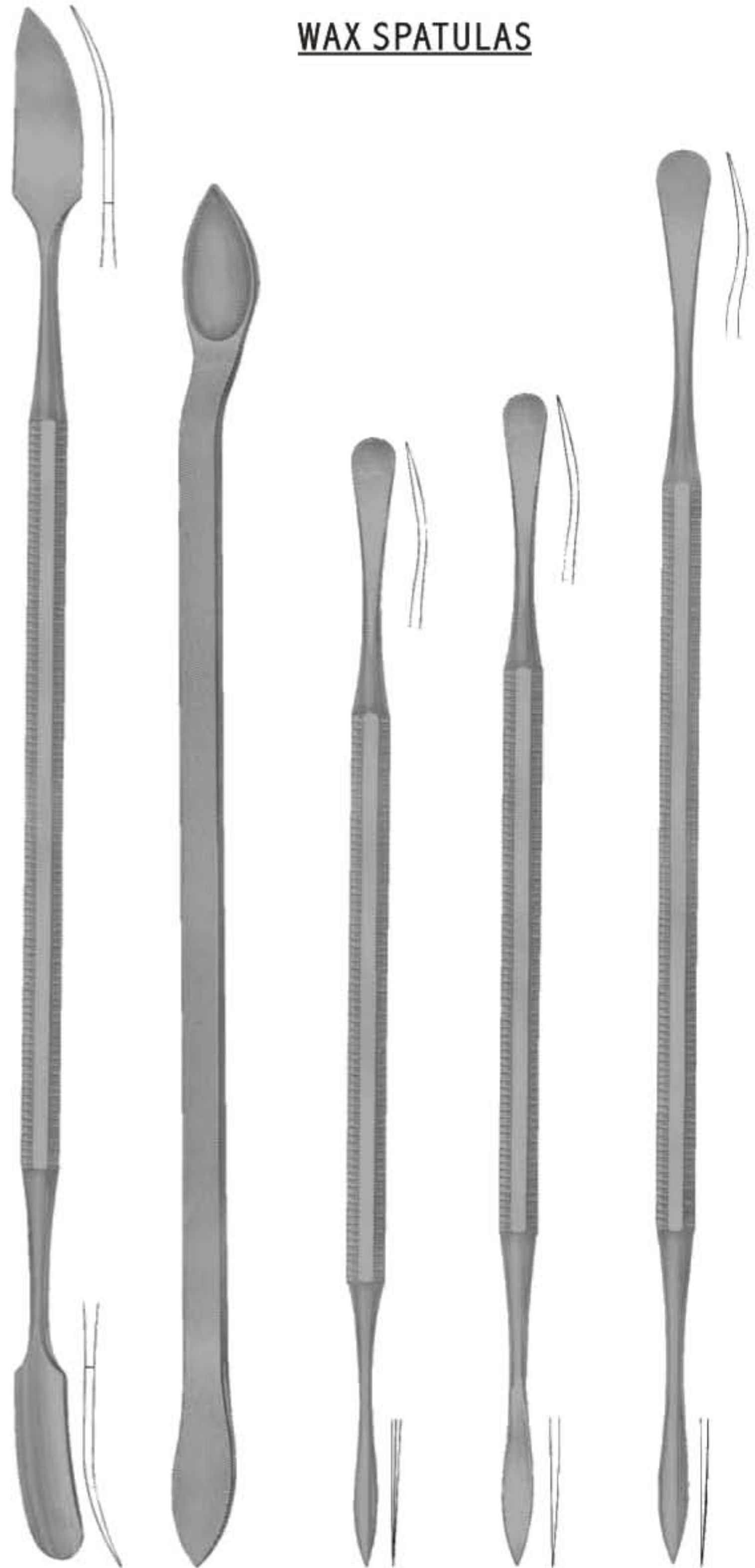

2140  
W-31

2141  
W-5

2142  
W-7

2143  
W-7A

2144  
W-7G



2145  
AGATHE

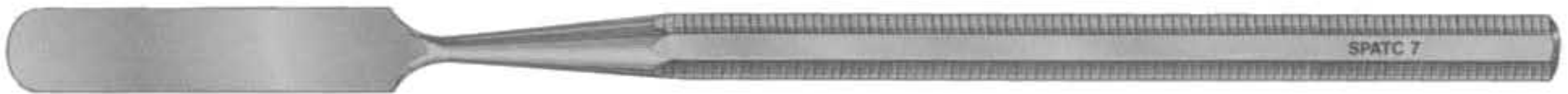

2146  
C-7



2147  
C-5



2148  
C-313



2149  
C-24A Rigid



2150  
C-24 Flexible



2151  
C-24 Flexible



2152  
24



2153  
A6



2154  
7 Wax



2155  
26



2156  
All Metal Spatulas with High Polish  
Stainless Steel Blade



2157  
31

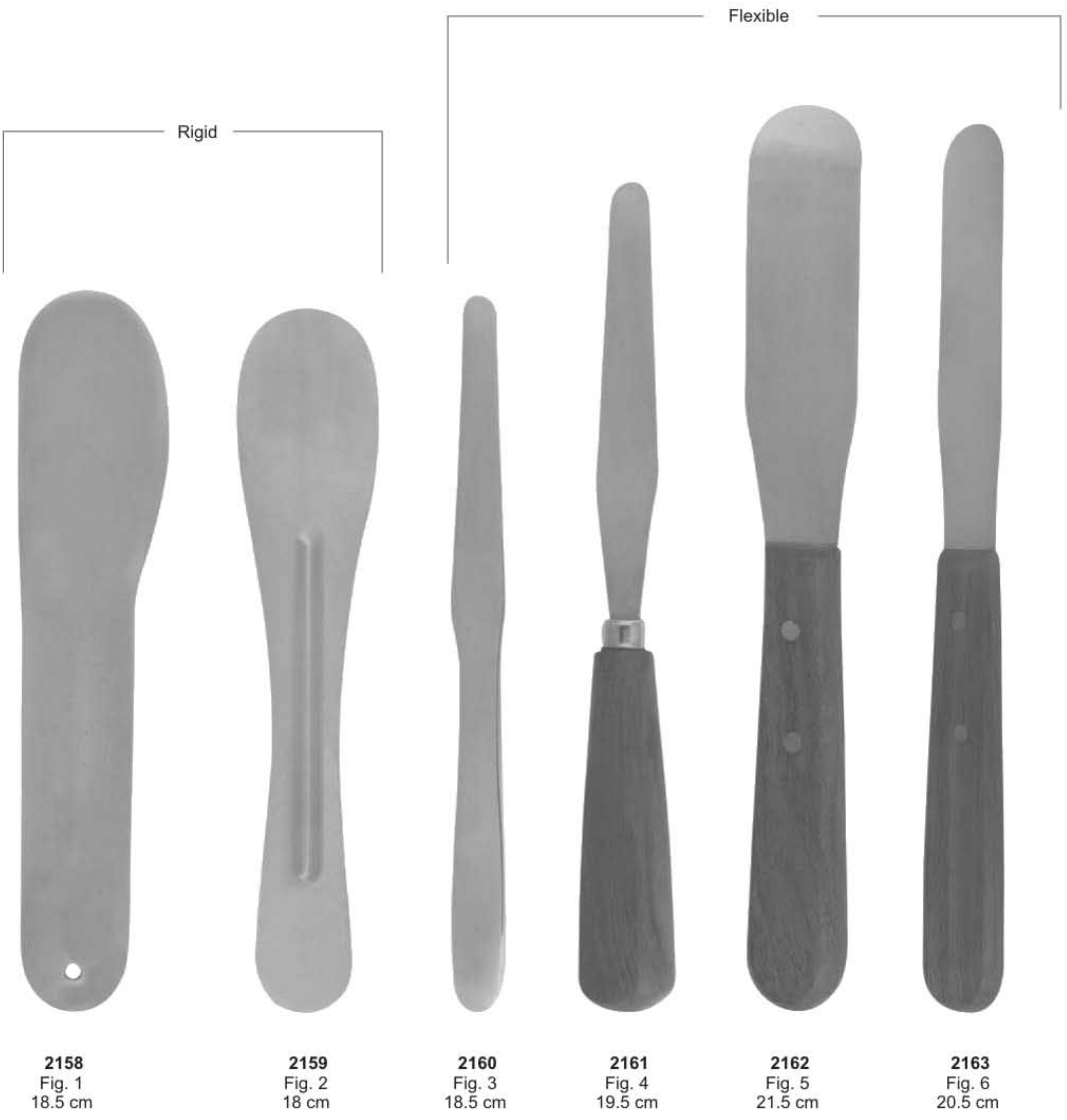



**2164**  
Fig. 7  
19.5 cm



**2165**  
Fig. 8  
20 cm



**2166**  
Fig. 9  
22.5 cm

FILES



2167  
Hirshfeld 3-7



2168  
Hirshfeld 5-11



2169  
Hirshfeld 9-10

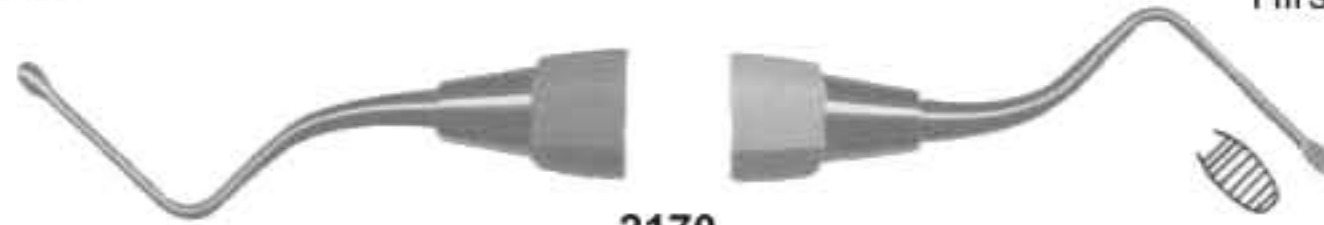

2170  
Orban 10-11

HOES



2171  
Orban 6-7



2172  
Orban 8-9



2173  
UWH 18-19



2174  
UWH 16-18



2175  
UWH 20-21



2176

KNIVES



2177  
Orban Knife (1-2)



2178  
1 SE



2179  
2-3

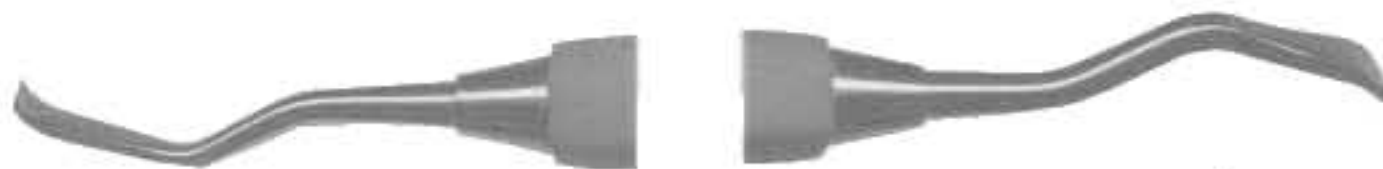

2180  
Kirkland 13-13L

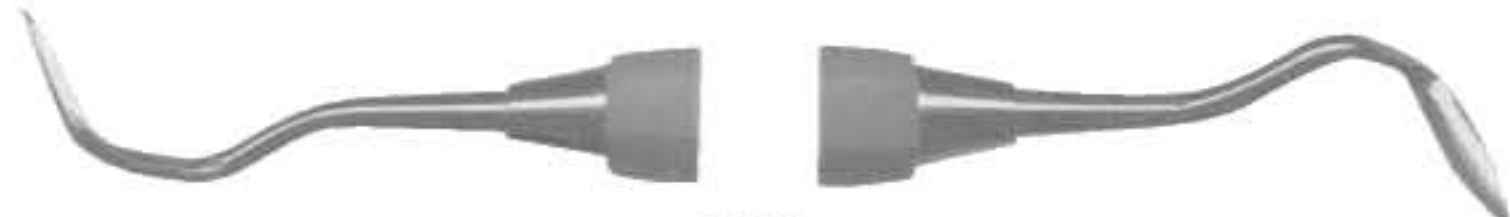

2181  
Knife Orban 1-2 TT DEO

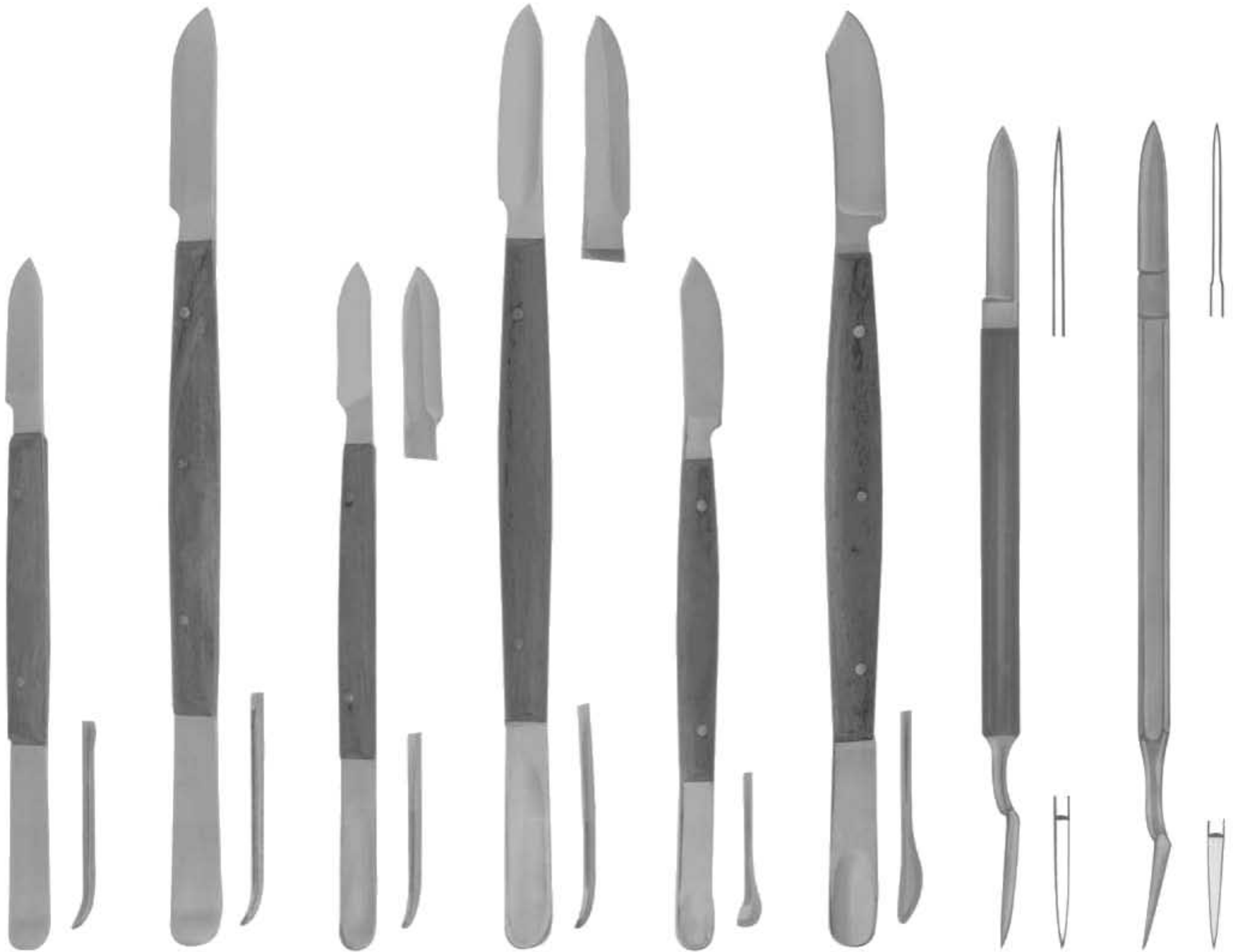

**2182**  
Fahnenstock  
Fig. 1  
12,5cm

**2183**  
Fahnenstock  
Fig. 2  
17cm

**2184**  
Lessmann  
Fig. 1  
12,5cm

**2185**  
Lessmann  
Fig. 2  
17cm

**2186**  
Con scodellino  
Fig. 1  
12,5cm

**2187**  
Con scodellino  
Fig. 2  
17cm

**2188**  
Ermert

**2189**  
Ermert



**2190**  
18 cm  
7 1/8"



**2191**  
18 cm  
7 1/8"



**2192**  
17 cm  
6 3/4"  
Gritman



**2193**  
17 cm  
6 3/4"  
Medicon



**2194**  
Fig. 1  
17 cm



**2195**  
22 cm  
8 3/4"



**2196**  
22 cm  
8 3/4"



**2197**  
Gritman  
Fig. 2  
17 cm



**2198**  
Fig. 3  
16 cm



**2199**  
Fig. 4  
16 cm

## CRANE-KAPLAN



**2200**  
Ck1  
Pocket Marker

**2201**  
Ck2  
Pocket Marker

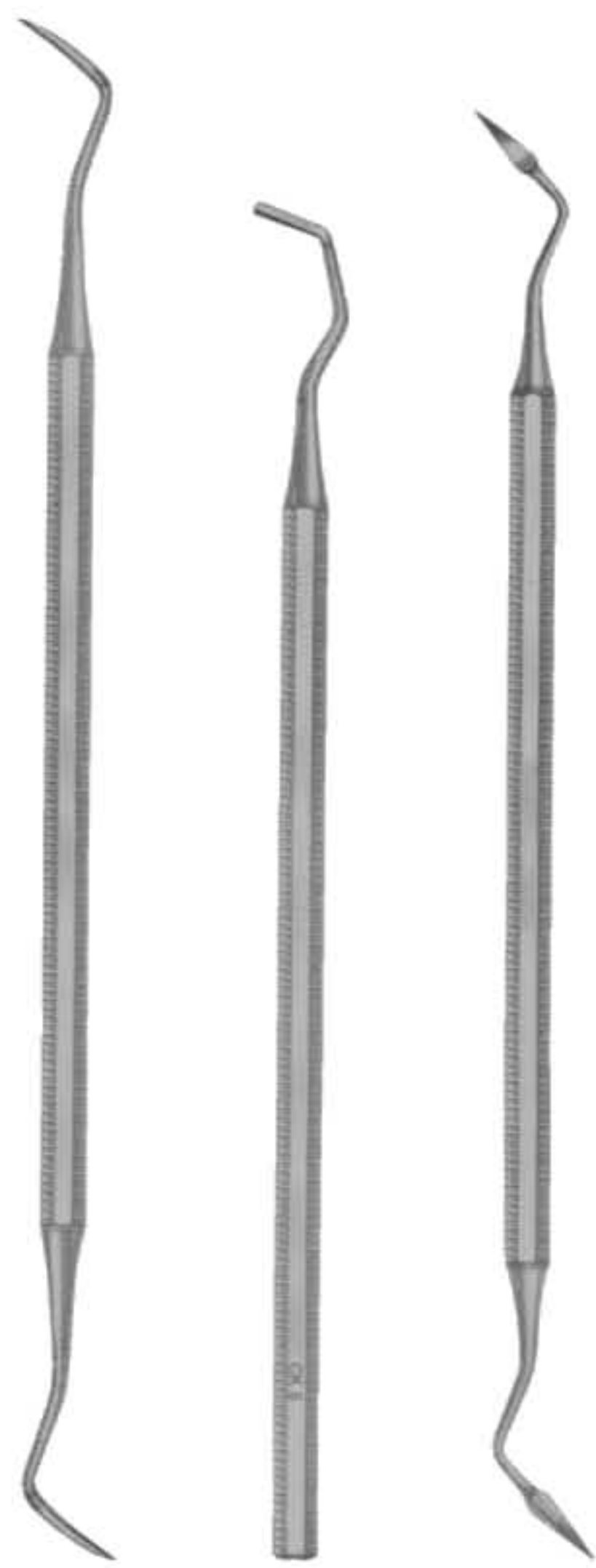

**2202**  
Knife

**2203**  
Dissector

**2204**  
Scaler

## OCHSENBEIN

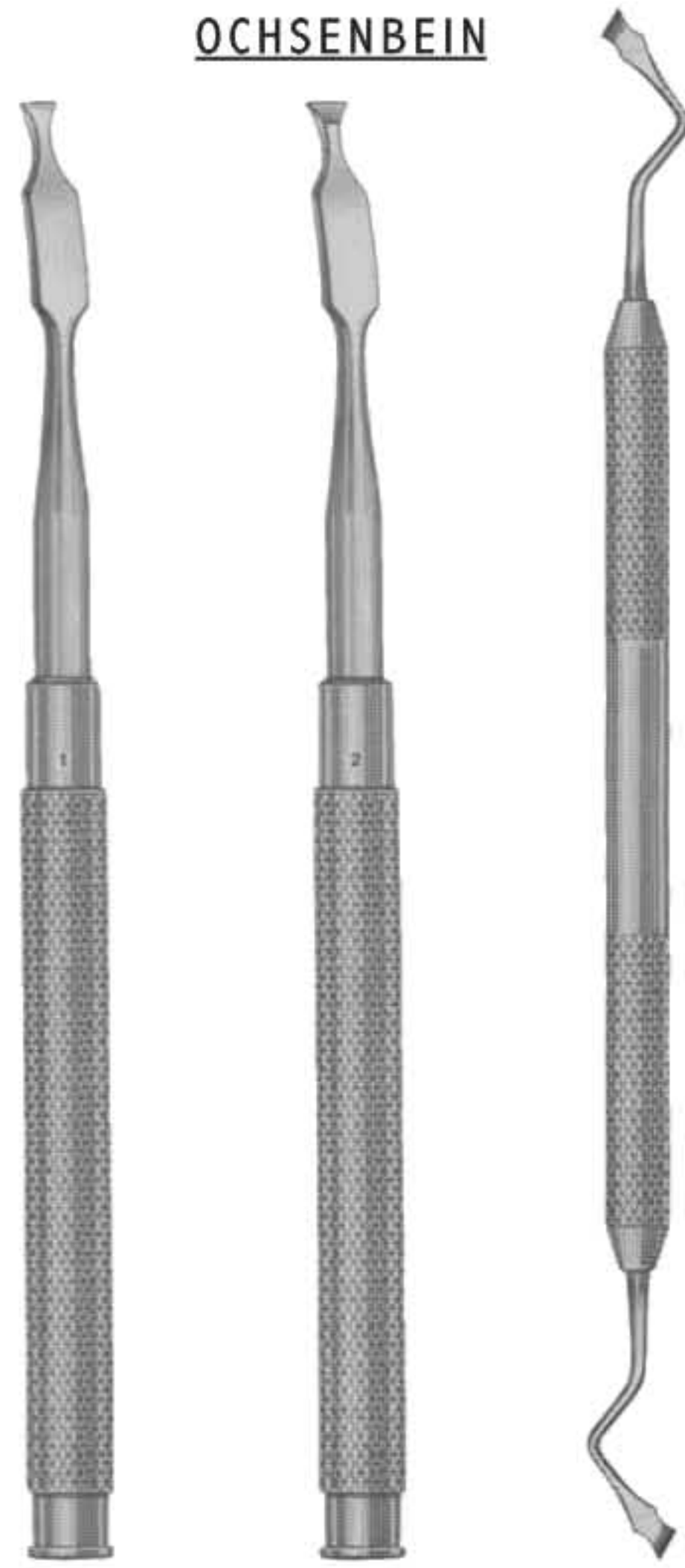

**2205**  
Ochsenbein  
Fig. 1

**2206**  
Ochsenbein  
Fig. 2

**2207**  
Ochsenbein  
Fig. 4

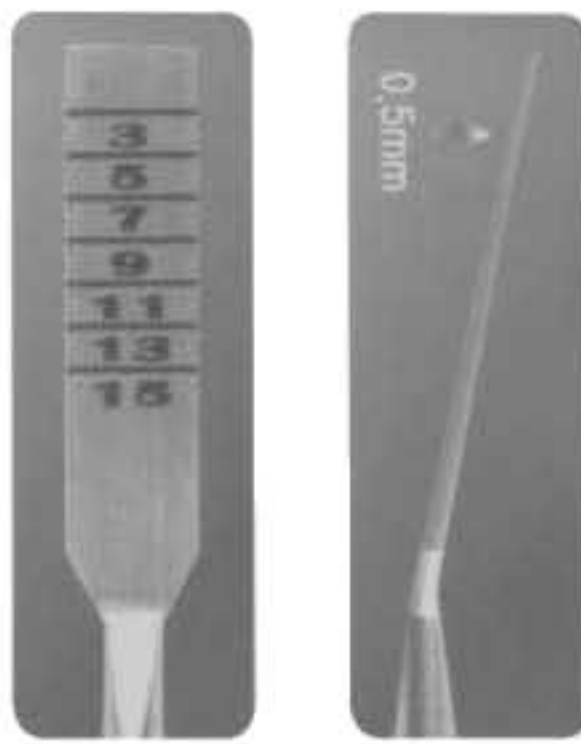

Split Chisel Set

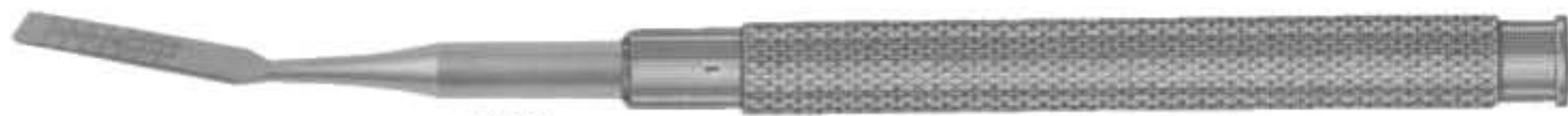

**2208**  
Split Chisel  
6 mm Curved

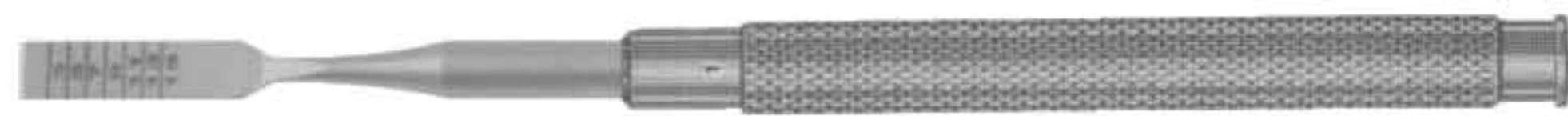

**2209**  
Split Chisel  
6 mm Straight



**2210**  
Split Chisel  
4 mm Curved



**2211**  
Split Chisel  
4 mm Straight



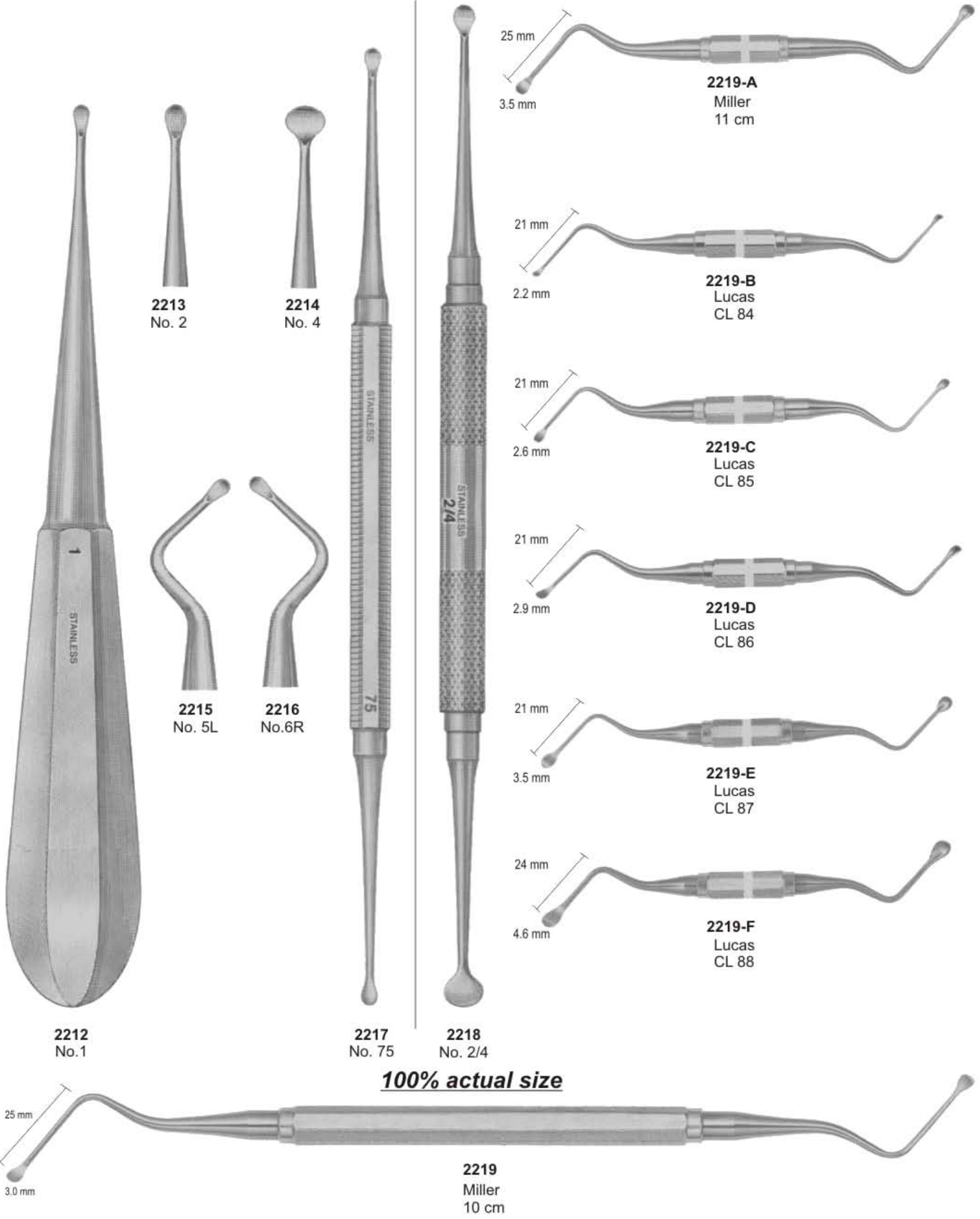

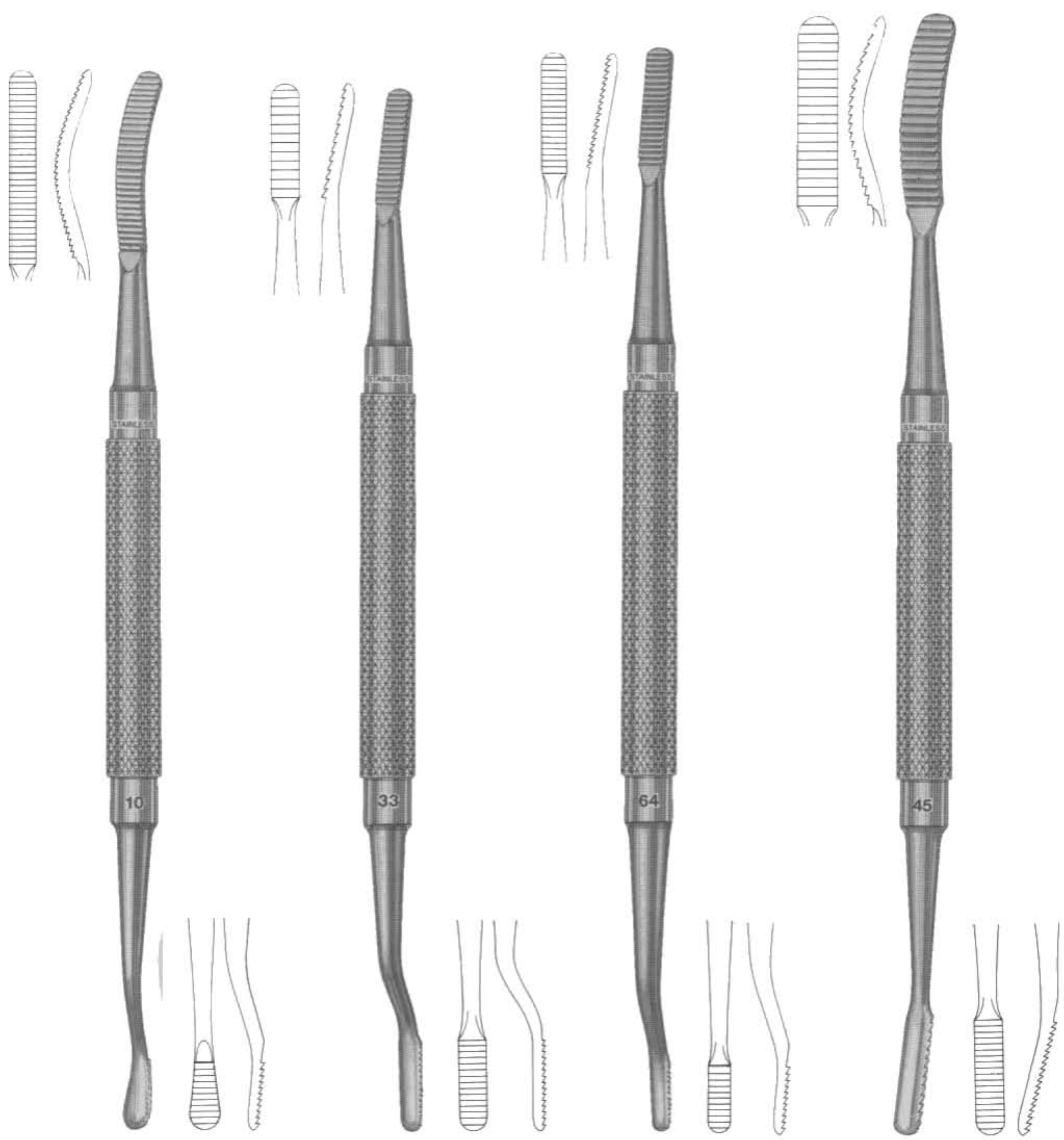

**2220**  
No. 10

**2221**  
No. 33

**2222**  
MILLER  
No. 33

**2223**  
MILLER  
No. 64

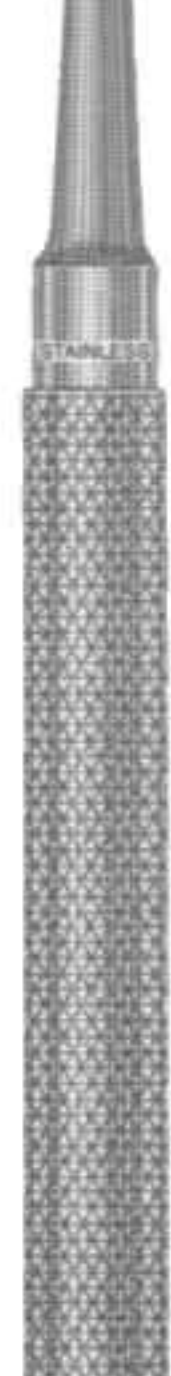
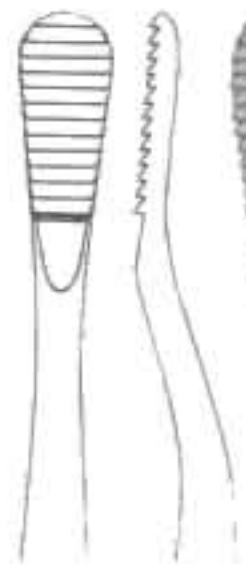

12

**2224**  
HOWARD  
No. 12

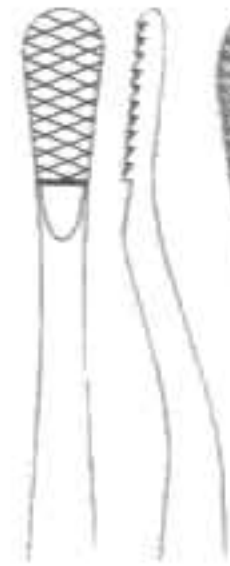

12A

**2225**  
HOWARD  
No. 12A

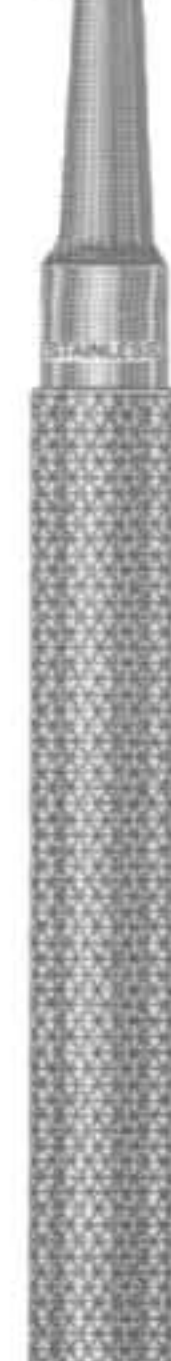

12CA

**2226**  
HOWARD  
No. 12CA

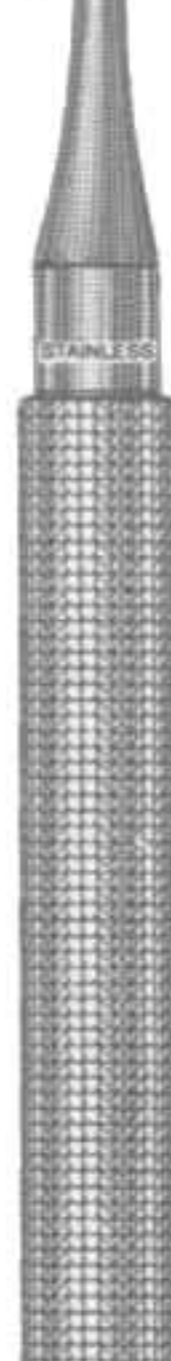
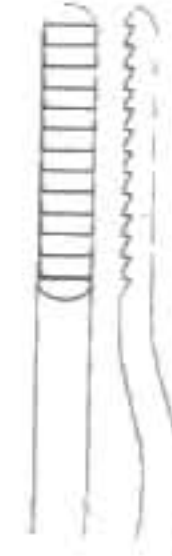

1P0

**2227**  
POLOKOFF  
No. 1

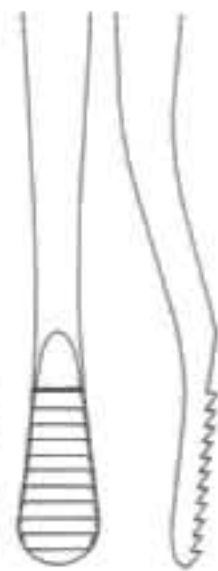

GARDNER

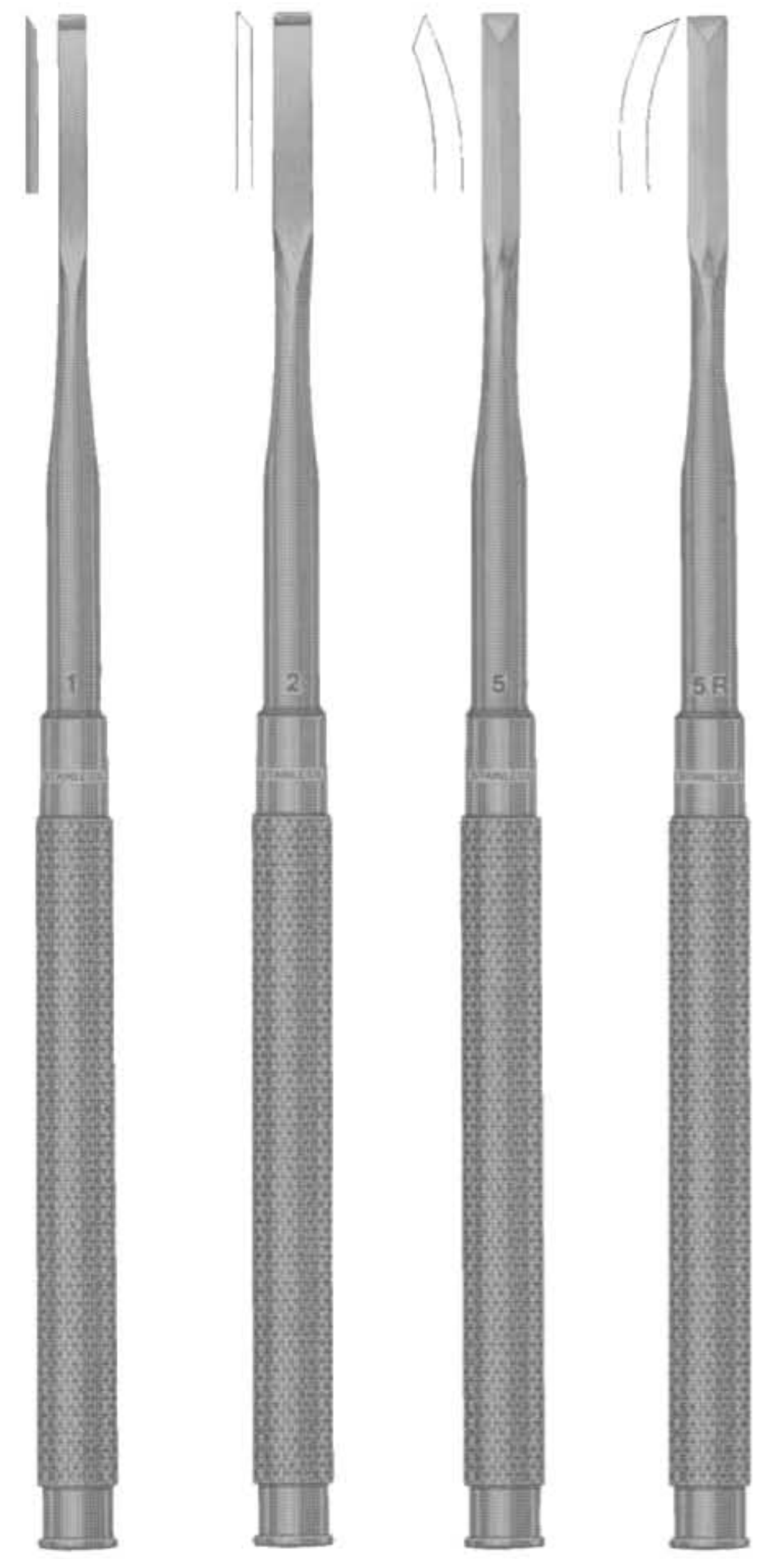

**2228**  
GARDNER  
No. 1

**2229**  
GARDNER  
No. 2

**2230**  
GARDNER  
No. 5

**2231**  
GARDNER  
No. 5R

WAKEFIELD



**2232**  
WAKEFIELD  
No. 1W

**2233**  
WAKEFIELD  
No. 2W



## Bone Chisels and Gouges

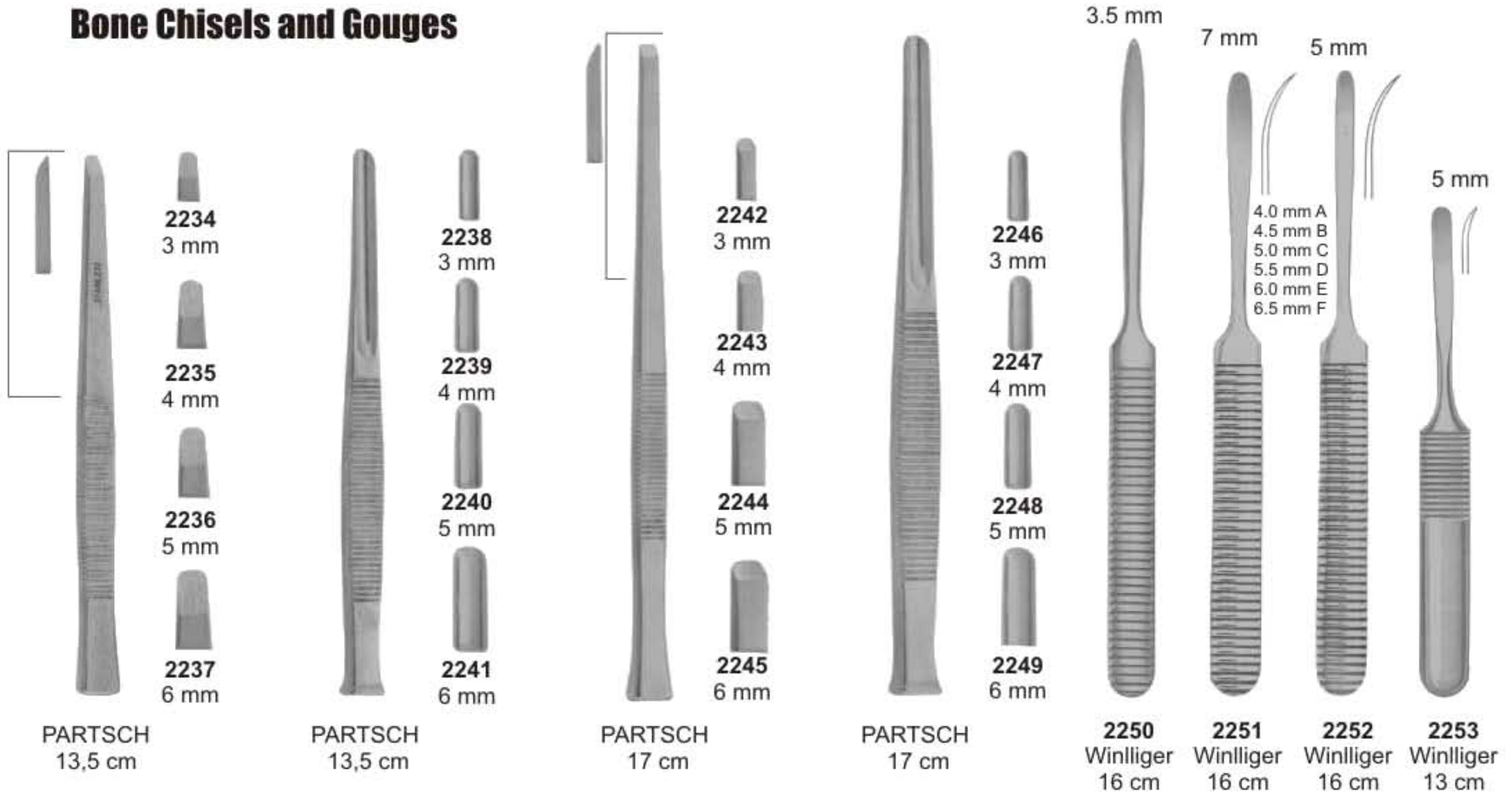

## Martelli chirurgici Mallet

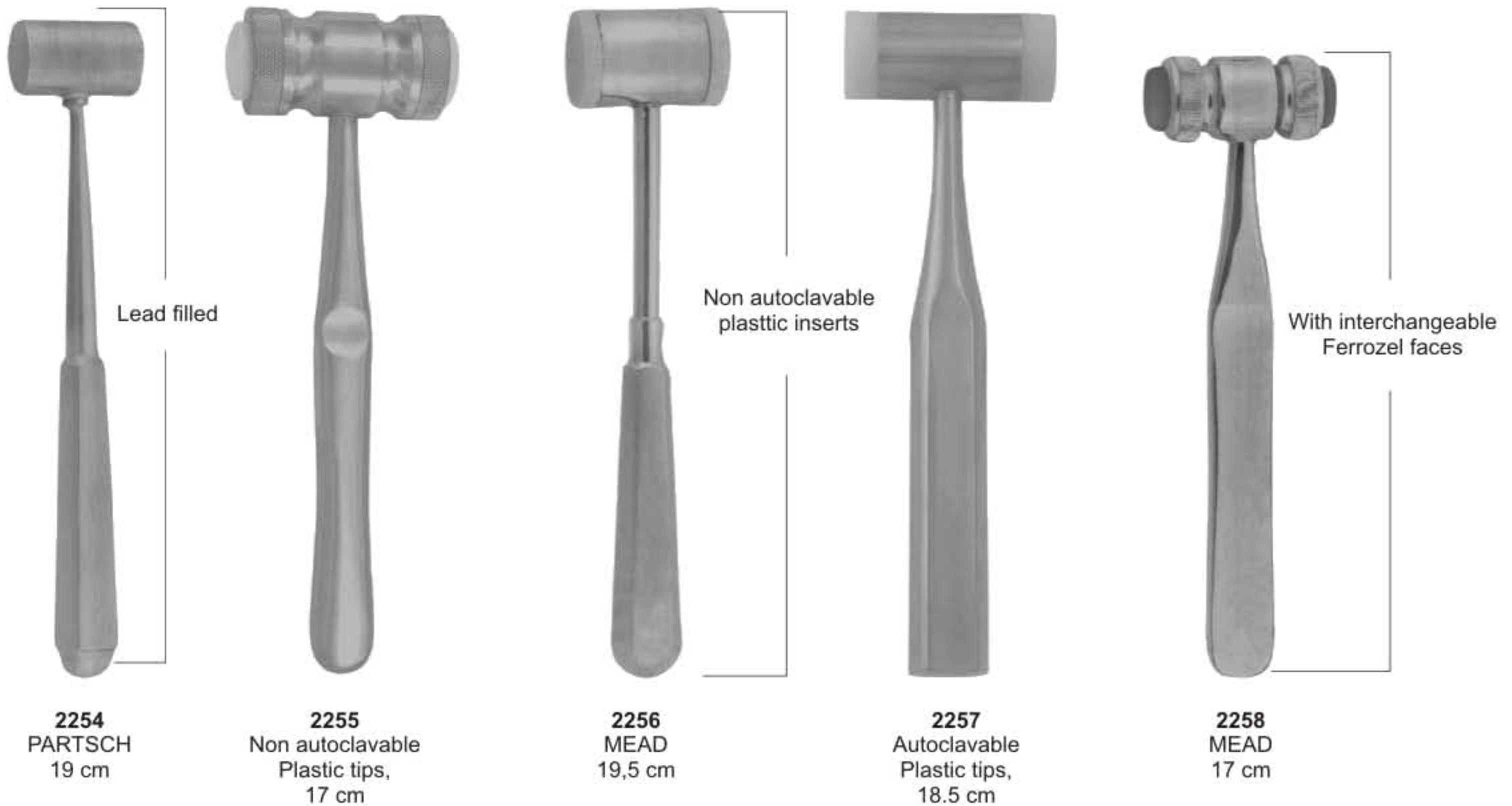

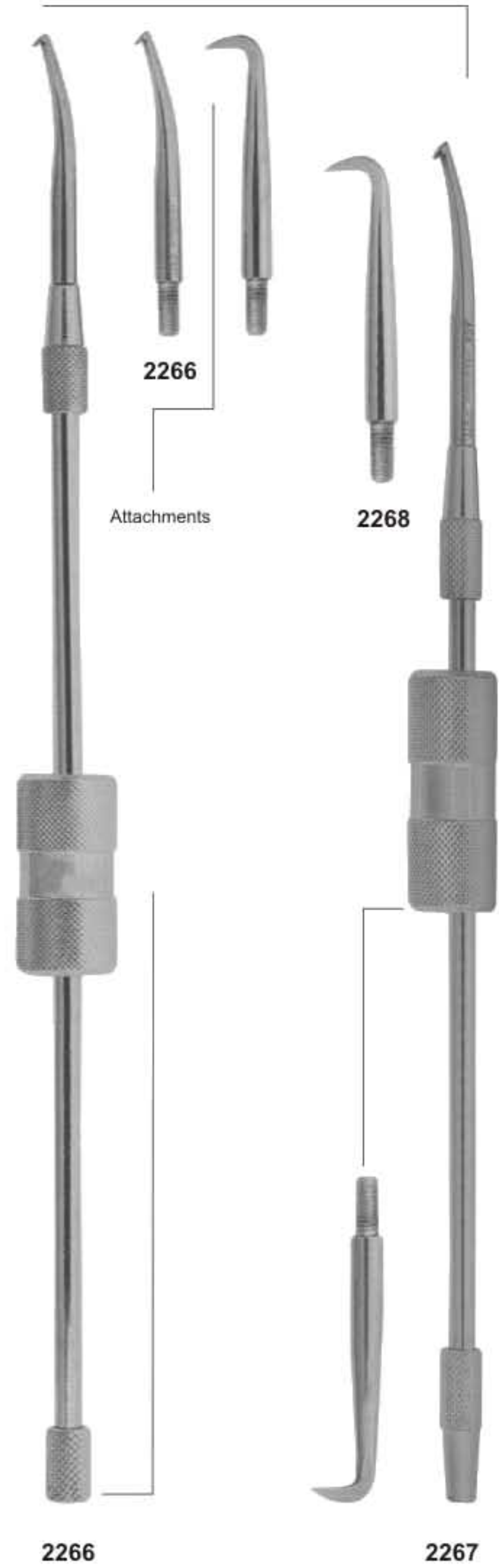
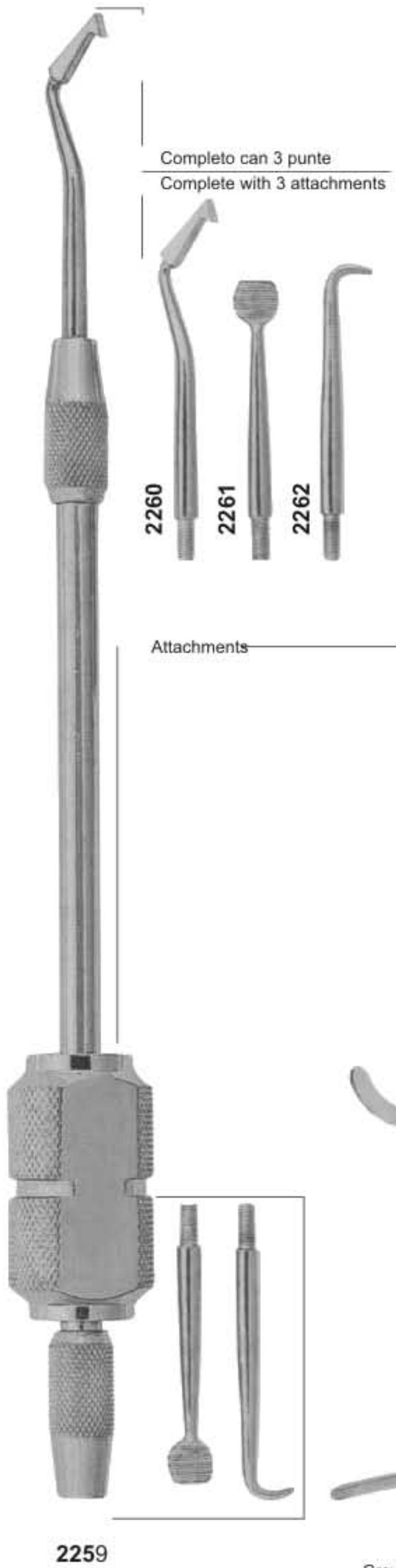

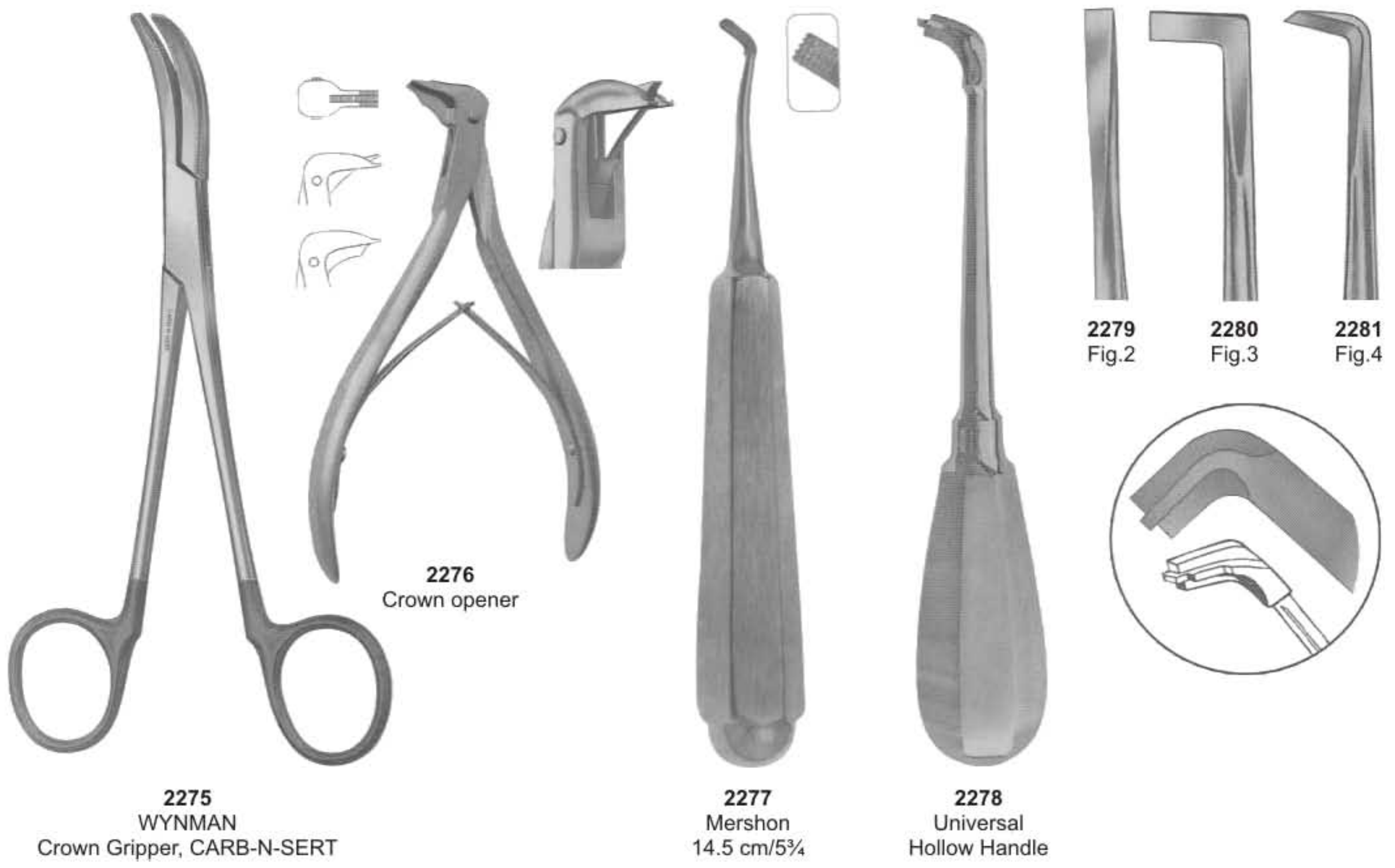
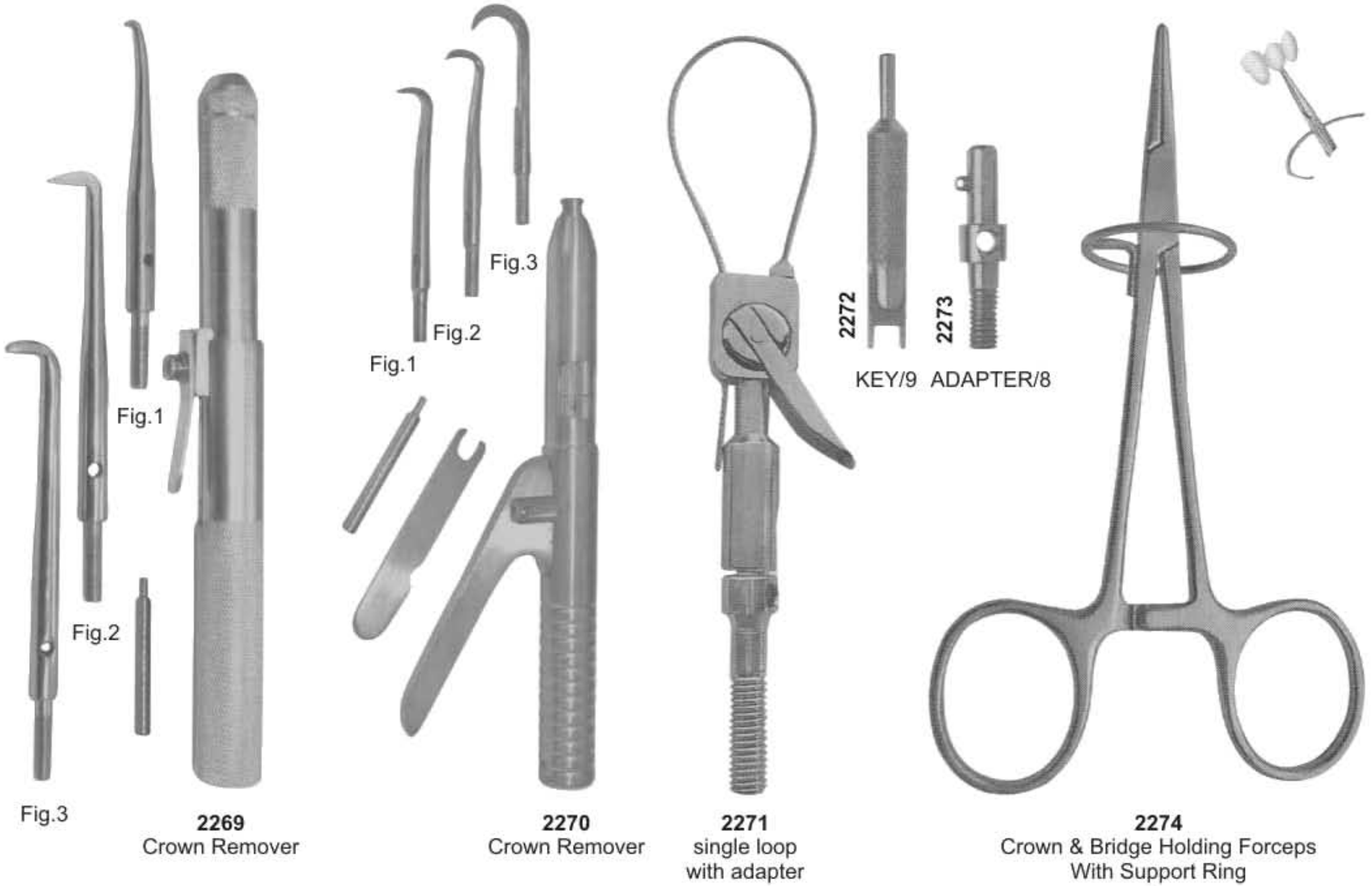



**2282**  
Plaster Shear  
210 mm

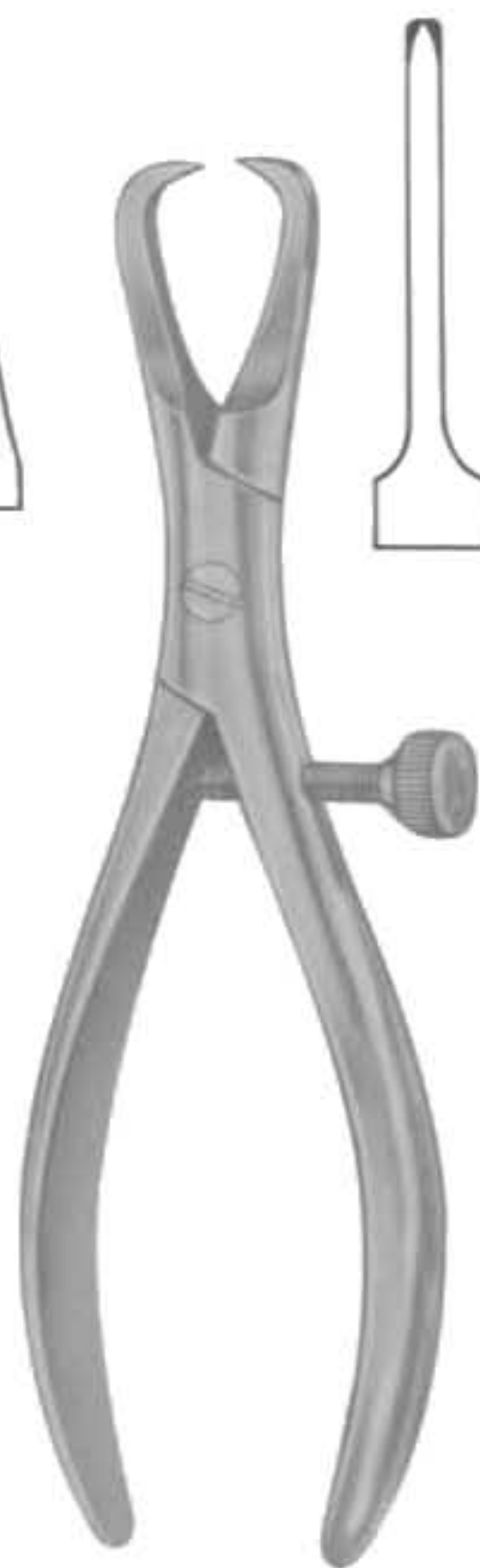

**2283**  
Crown Removing Plier  
14 cm



**2284**  
MONTFORT  
18 CM



**2285**  
BOHM  
16 cm



**2286**  
Telescope Crown  
Plier, Diamond coated  
13.0 cm



**2287**  
Telescope Crown  
Plier, Diamond coated  
13.0 cm



**2288**  
Telescope Crown Plier  
13.0 cm gerieften Maul  
15.0 cm gerieften Maul  
13.0 cm gelatts Maul  
15.0 cm gelatts Maul



**2289**  
Telescope Crown  
Plier, Fine  
15.0 cm



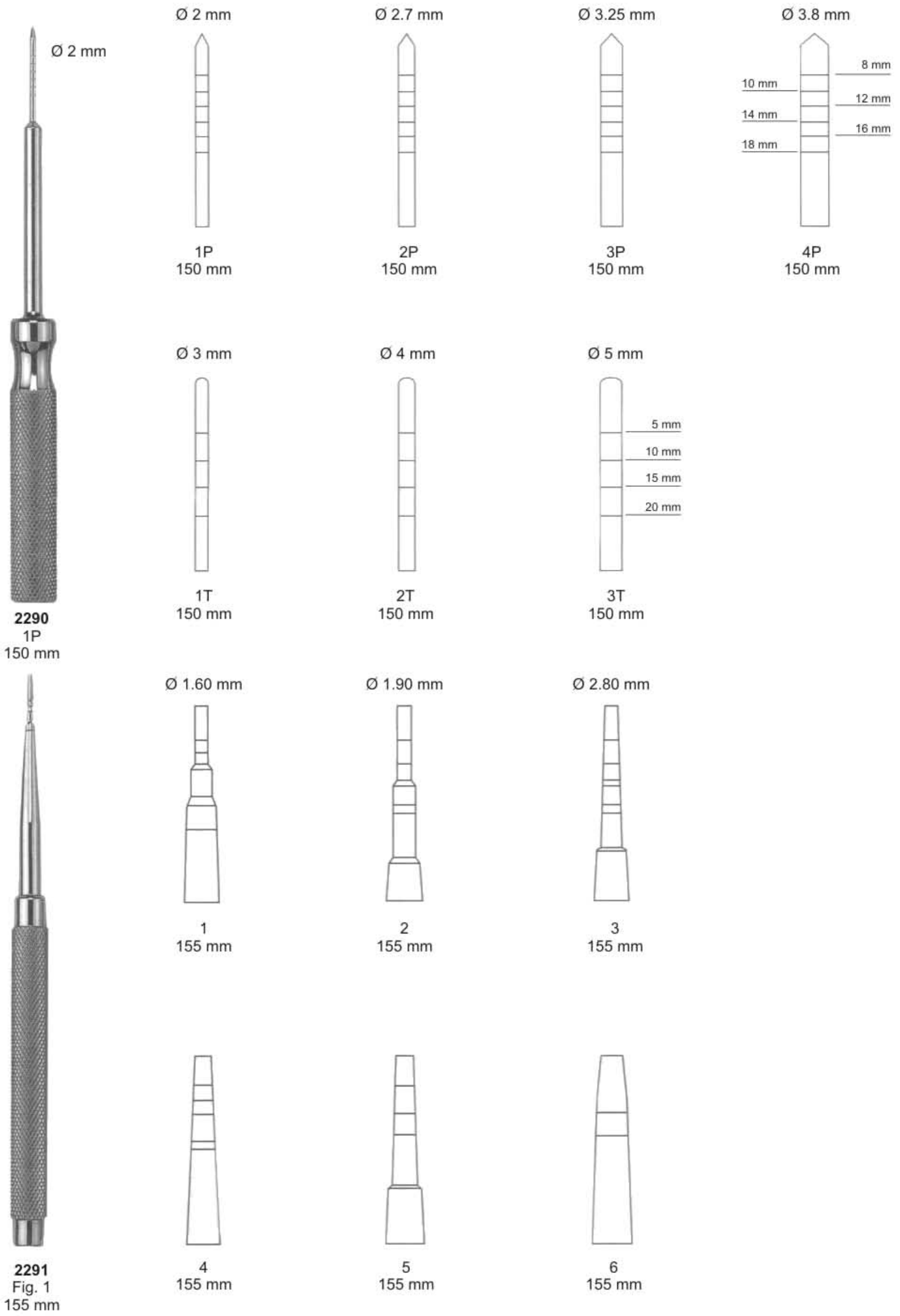



**2292**  
Fig. 1B  
165 mm

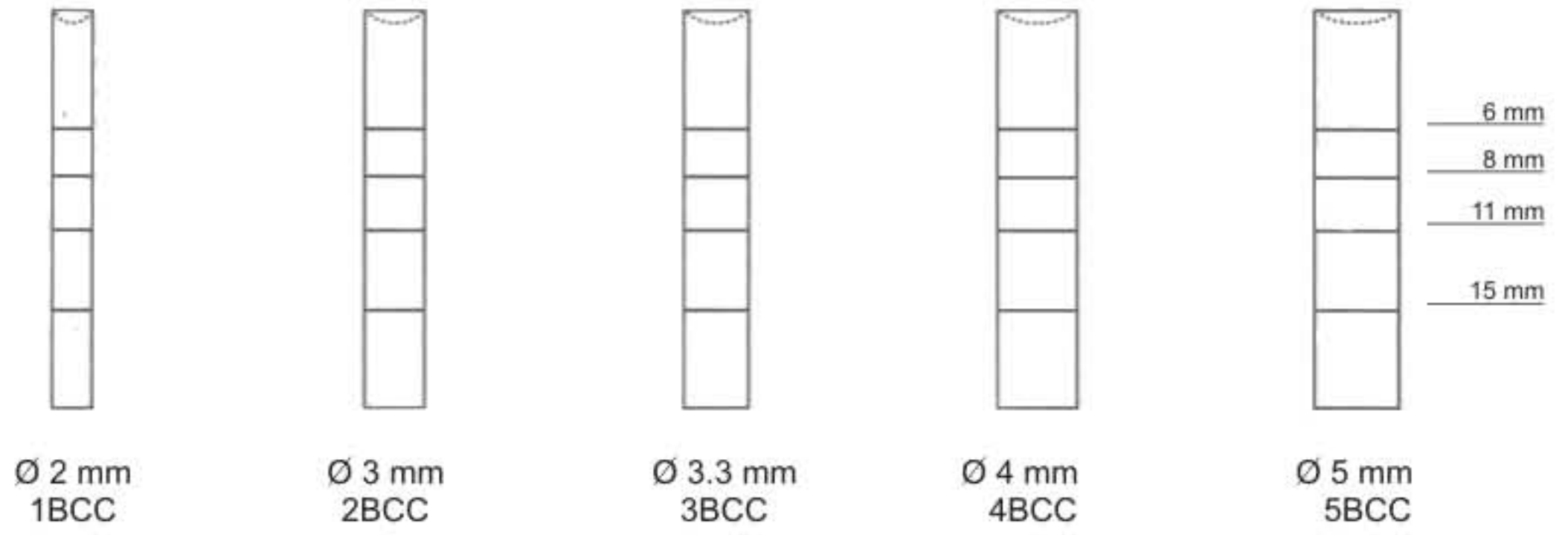
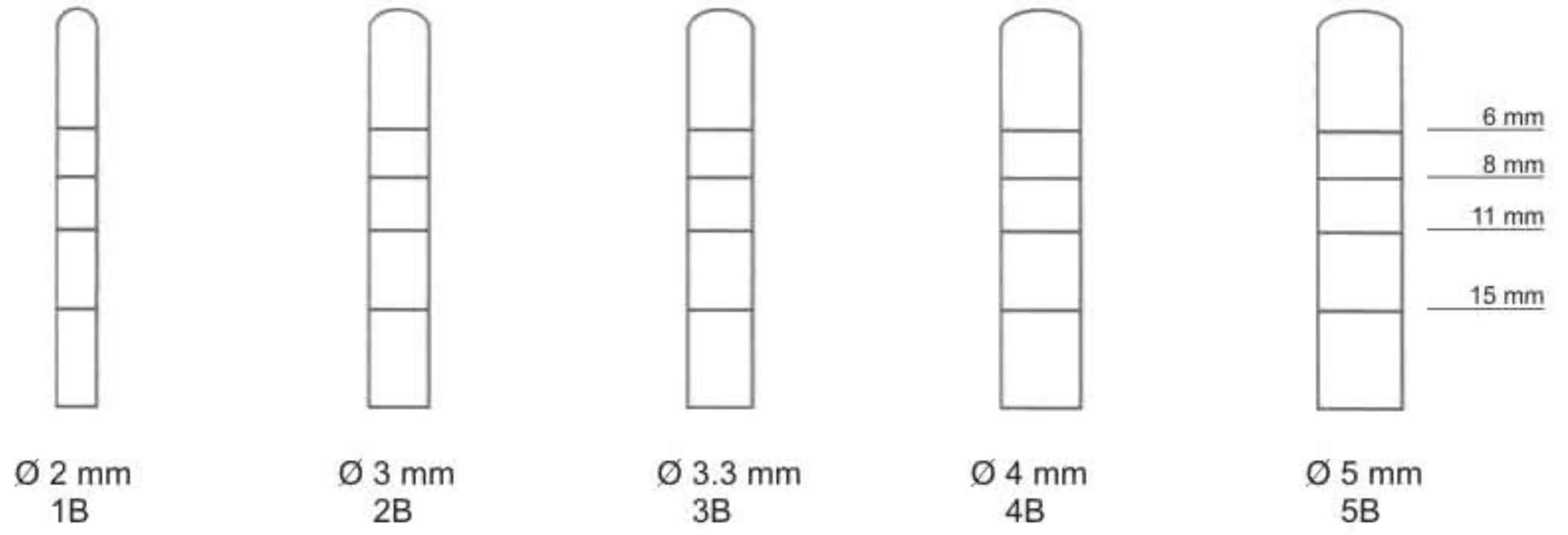

**2293**  
Fig. 1  
155 mm

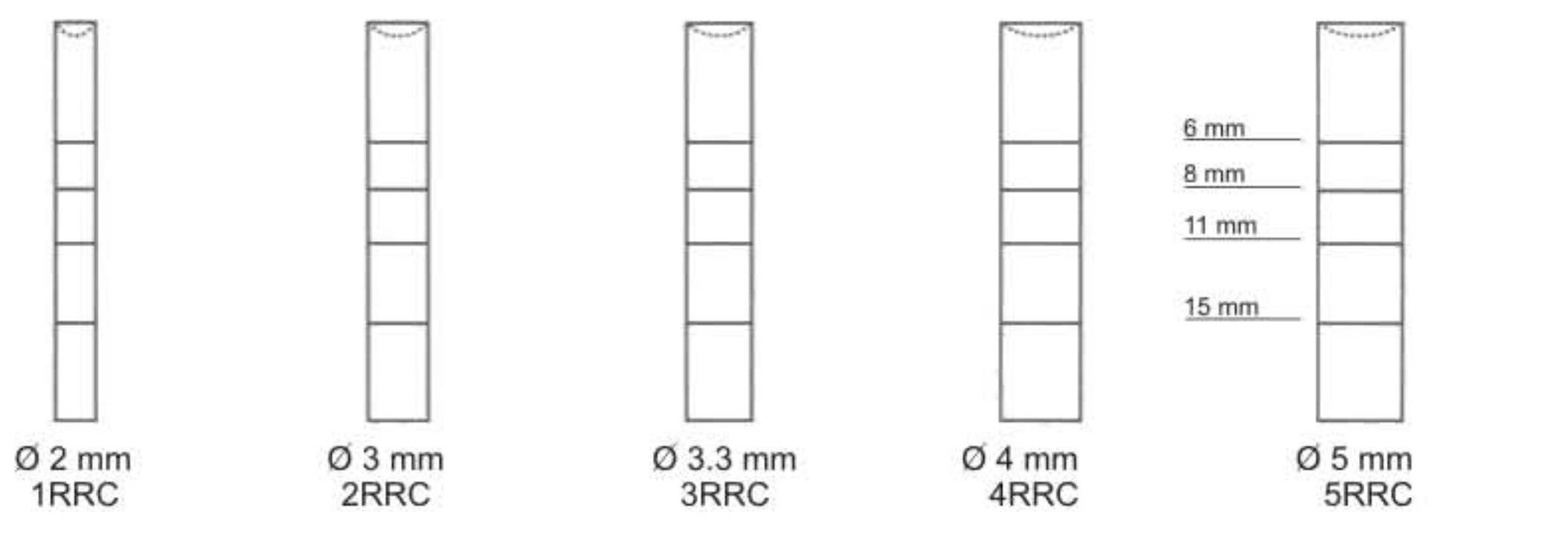
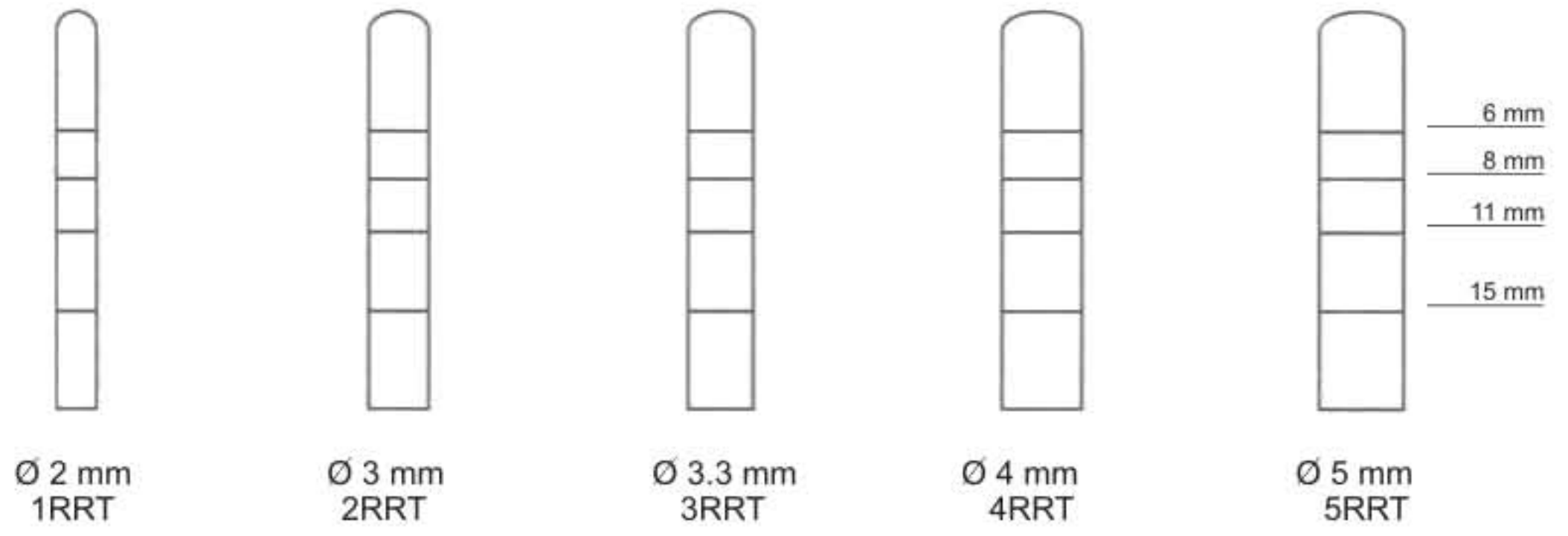

## Endo guns for retrograds.

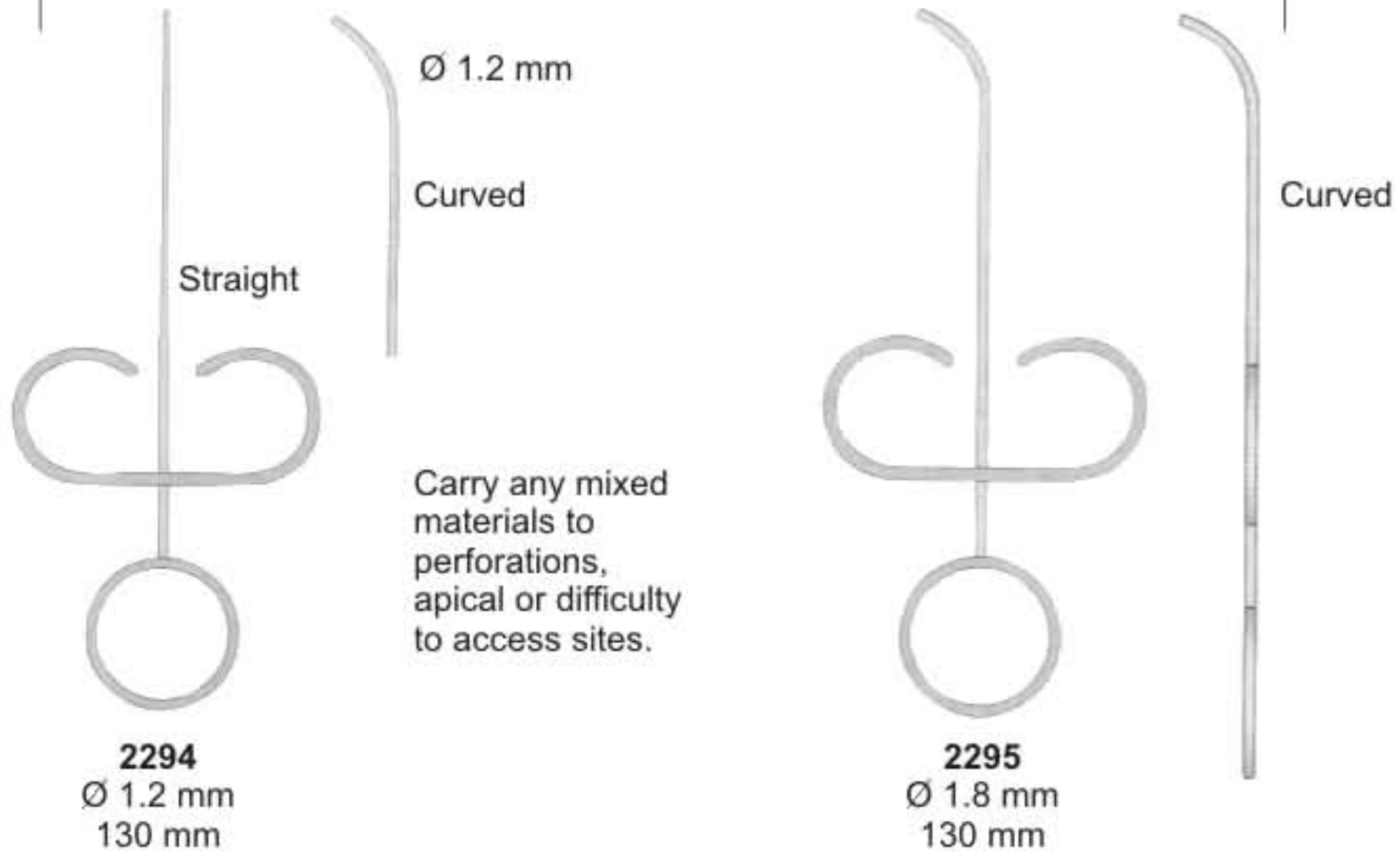

## Bone Injectors



Bone well

**2301**  
Ø 35 mm  
h 35 mm



**2302**  
Grinders for autogenous

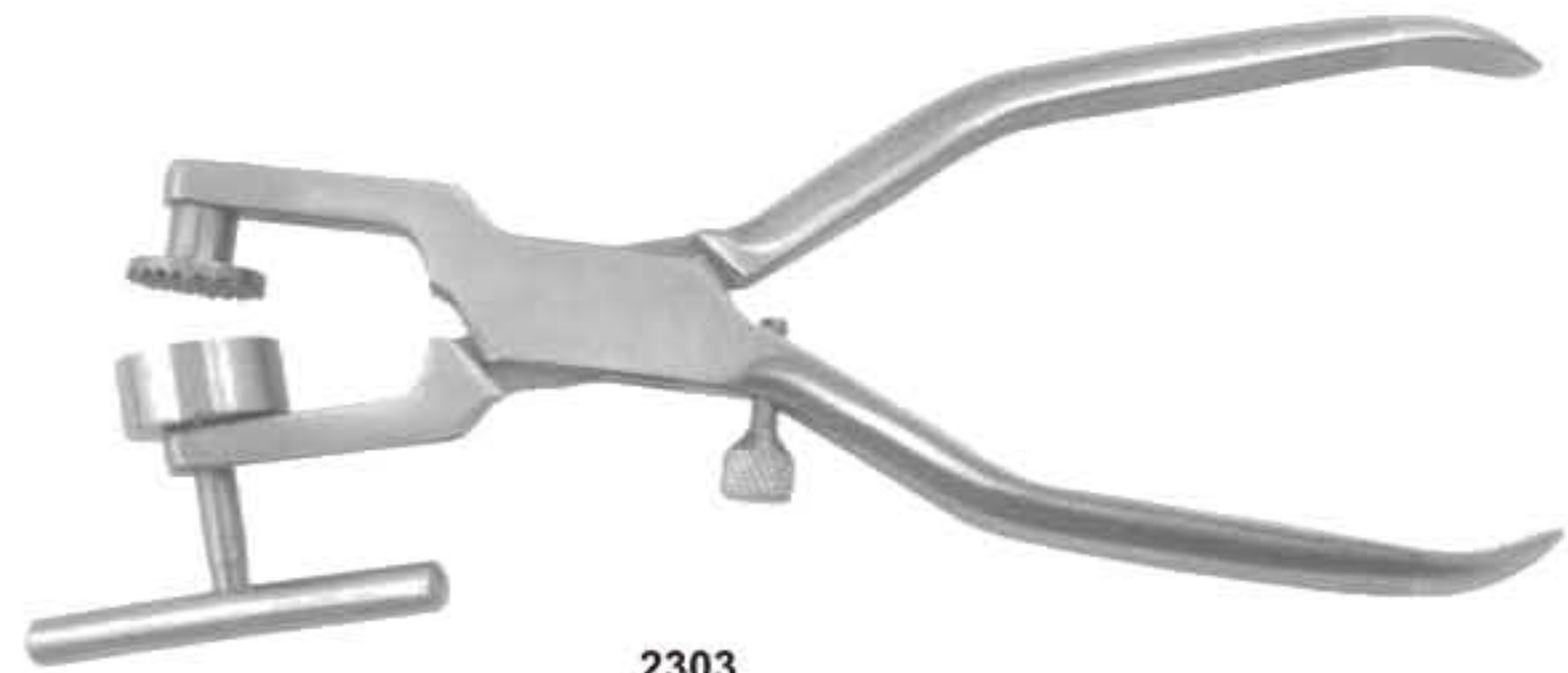

**2303**  
Bone Mill Forcep  
17.0 cm

**Suction Tubes**

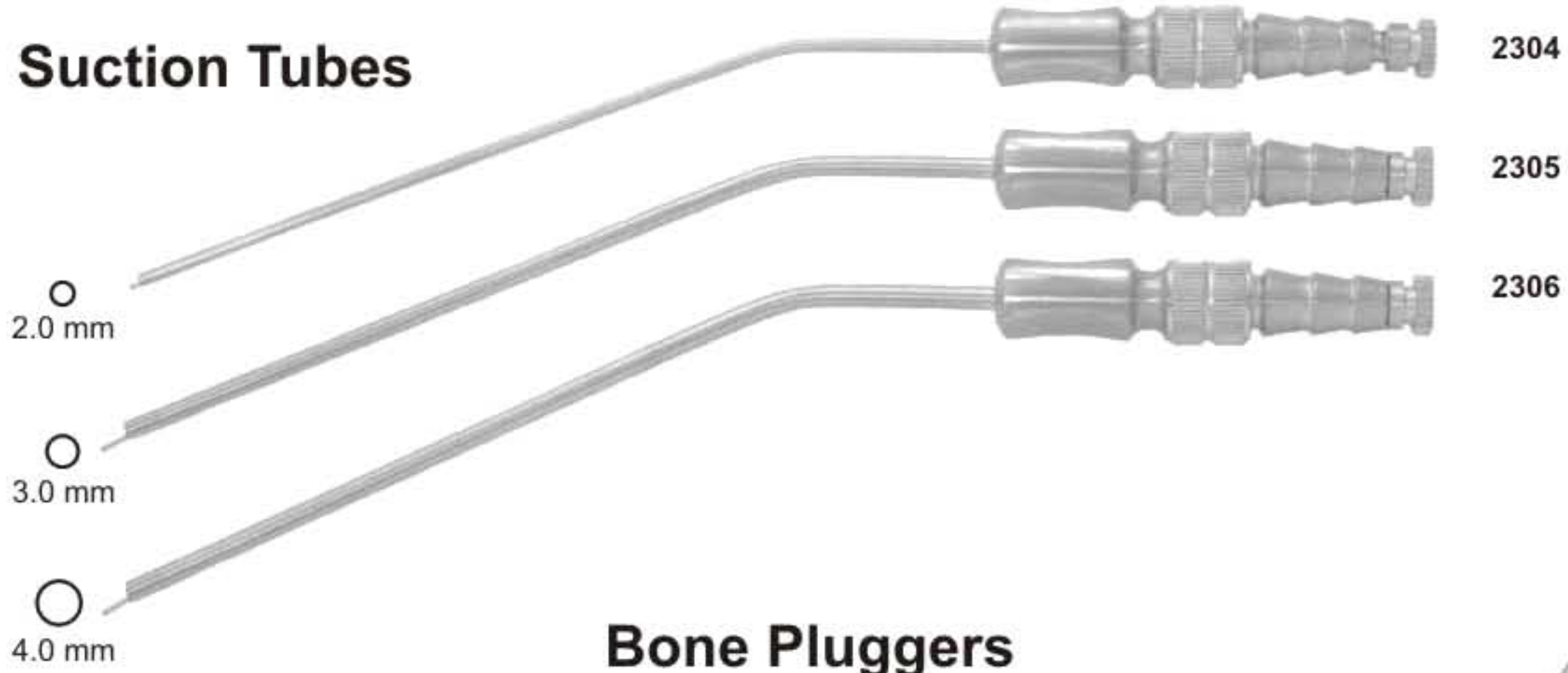

**Bone Pluggers**



**Kerrison Rongeurs**



- ( 1.5 mm inside ) 2311
  - ( 2.0 mm inside ) 2312
  - ( 3.0 mm inside ) 2313
  - ( 4.0 mm inside ) 2314
  - ( 4.5 mm inside ) 2315
- 16.5 cm**

- ( 1.0 mm inside ) 2316
  - ( 2.0 mm inside ) 2317
  - ( 2.50 mm inside ) 2318
- 16.5 cm**

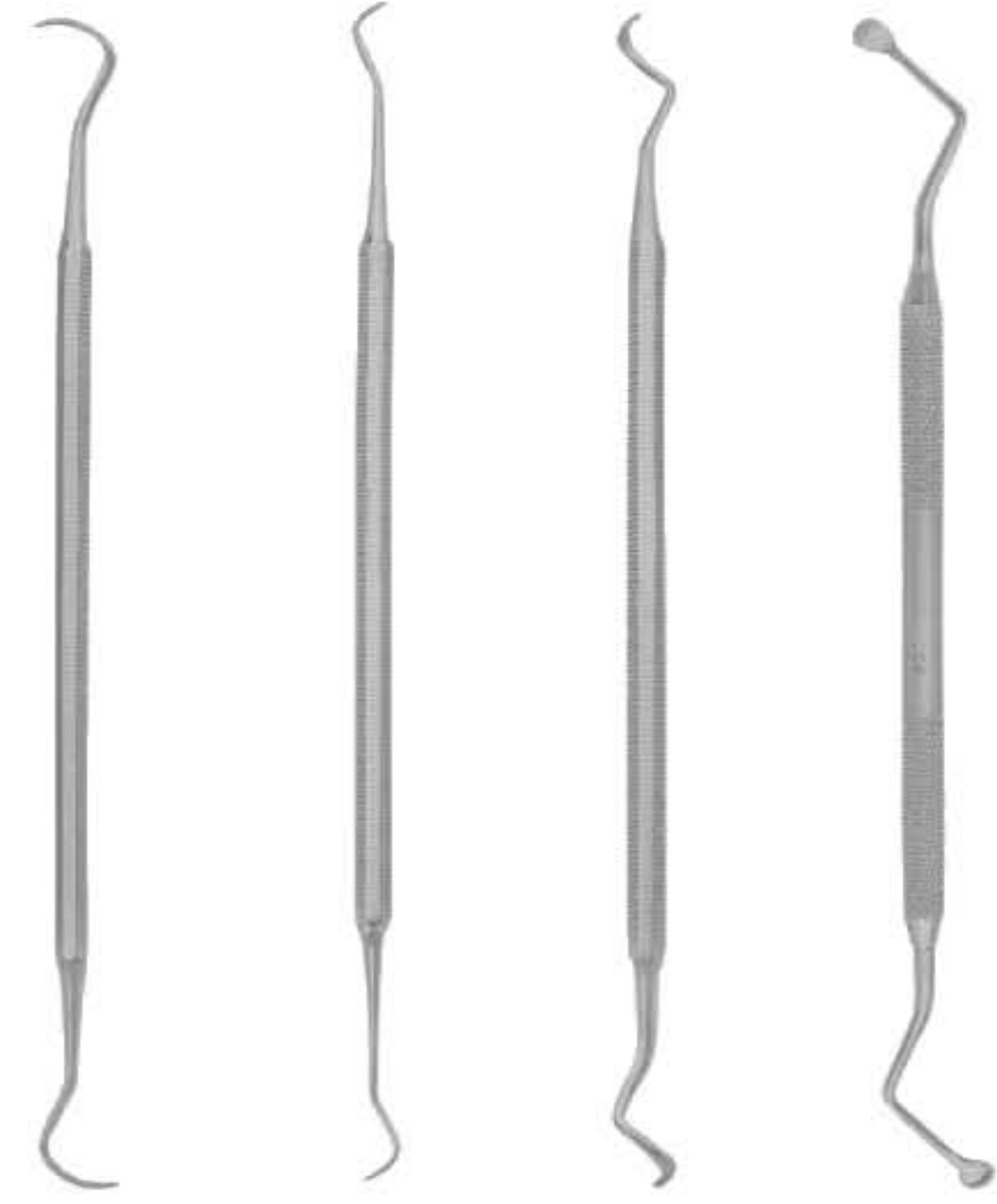

**2319**  
Fig. 1  
170 mm

**2320**  
Fig. 2  
175 mm

**2321**  
Fig. 3  
170 mm

**2322**  
LUCAS  
Fig. 88  
170 mm

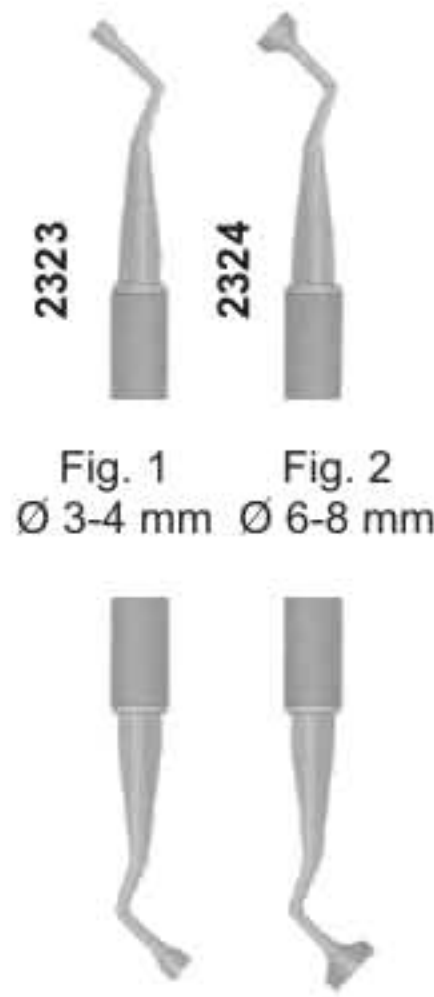
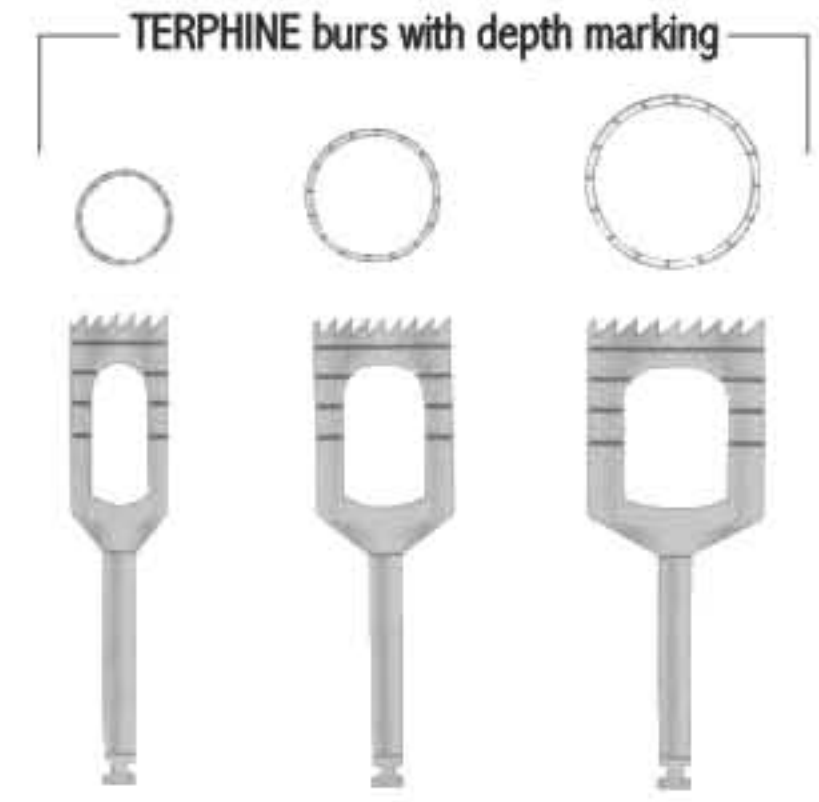

Fig. 1  
Ø 3-4 mm

Fig. 2  
Ø 6-8 mm

Bone Compactors.



**2325** Ext. Ø 3.5 mm Int. Ø 3 mm

**2326** Ext. Ø 6 mm Int. Ø 5 mm

**2327** Ext. Ø 8.5 mm Int. Ø 7.55 mm

**2328** Ext. Ø 11 mm Int. Ø 10 mm

## Sinus lift instruments

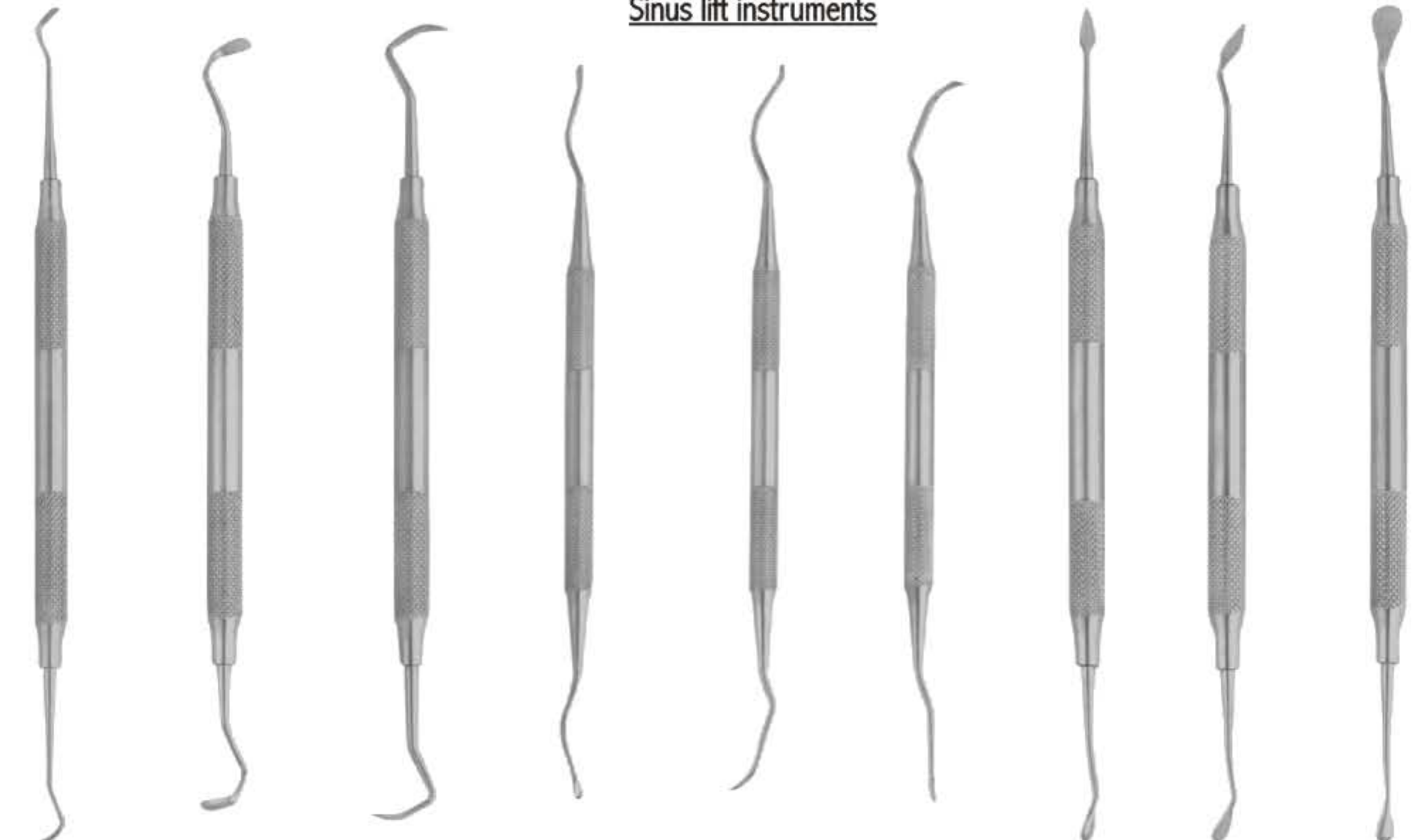

**2329**  
Fig.1

**2330**  
Fig.2

**2331**  
Fig.3

**2332**  
Fig.4

**2333**  
Fig.5

**2334**  
Fig.6

**2335**  
Fig.7

**2336**  
Fig.8

**2337**  
Fig.9

- 

Canula, Curved **2338**
- 

Canula, Curved **2339**
- 

Canula, Curved **2340**
- 

Canula, Curved **2341**
- 

Canula, straight **2342**
- 

Canula, Curved **2343**
- 

Canula, Curved **2344**
- 

Canula, Curved **2345**
- 

Canula, Curved **2346**
- 

Canula, Curved **2347**  
3.0 mm A  
4.0 mm B  
5.0 mm C

○  
2.0 mm

○  
3.0 mm

○  
4.0 mm

○  
2.0 mm

○  
3.0 mm

○  
4.0 mm

- Measuring Instruments
- Amalgam Guns & Carriers
- Retainers
- Rubber Dam Instruments
- Syringes
- Tweezers
- Sterilizing & Lab. Instruments



# 05

SECTION





**2348**  
BOLEY Gauge



**2349**  
ZURICHER  
130 mm



**2350**  
VERNIER  
12 cm



**2351**  
VERNIER



**2352**  
VERNIER Gauge



**2353**  
VERNIER Gauge



**2355**  
Finger Ruler



**2354**  
LWANSON  
Crown Gauge



**2356**  
LWANSON  
Crown Gauge



**2357**  
Sliding Gauge  
10 cm



**2358**  
Spring Bow Divider  
6" Radius



**2359**  
VERNIER  
Gauge



**2360**  
ALBEE



**2361**  
Height Gauge  
Wick Type



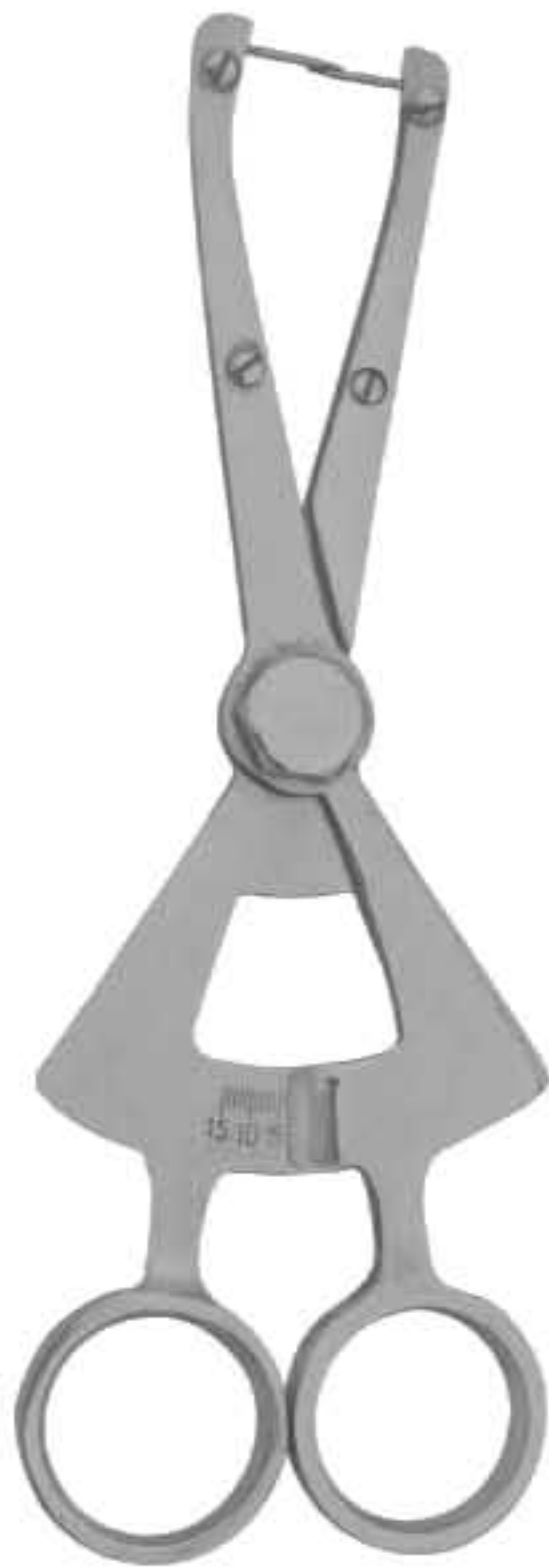

**2362**  
Bone Gauge



**2363**  
Bone Caliper  
15 cm



**2364**  
Castroviejo



**2365 A**  
Castroviejo  
Curved



**2365 B**  
Straight



**2366 C**  
Castroviejo  
Straight



**2366 D**  
Curved



**2367**  
Gauge

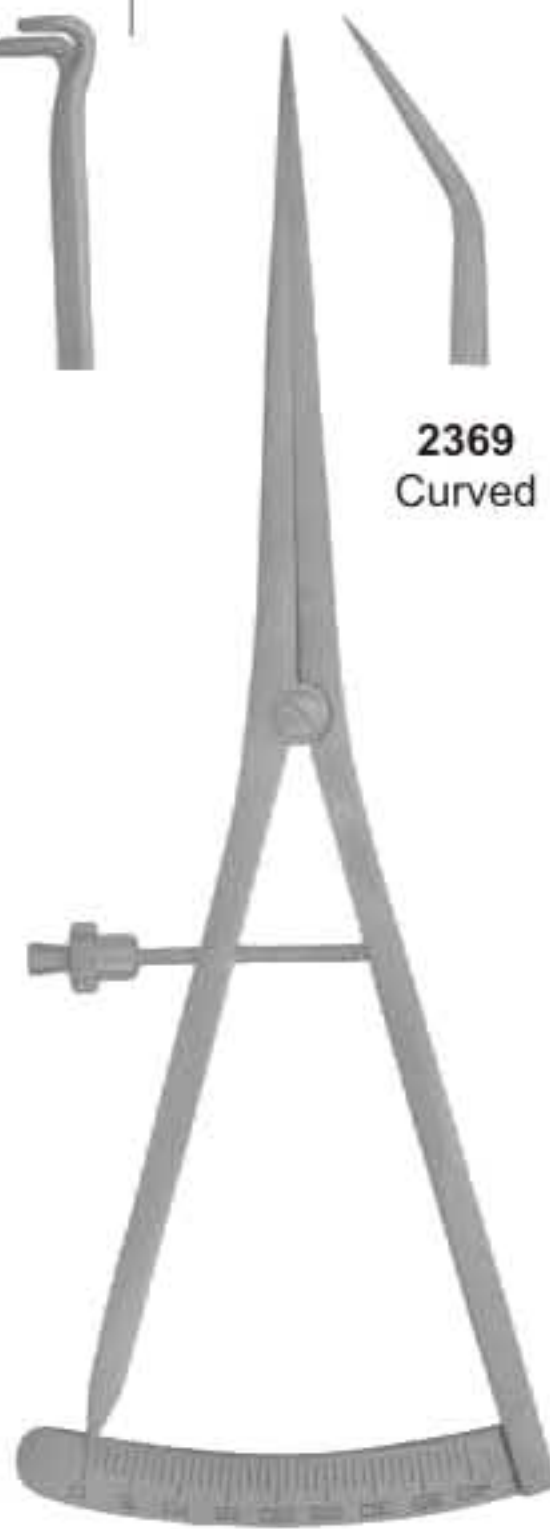

**2368**  
Castroviejo  
Straight



**2369**  
Curved



**2370 A**



**2371**  
Curved



**2373**  
Boone - Gauge



**2372**  
Castroviejo



**2374**  
Curved



**2375**  
Straight



**2376**  
Bracket Gauge. Ant/Post



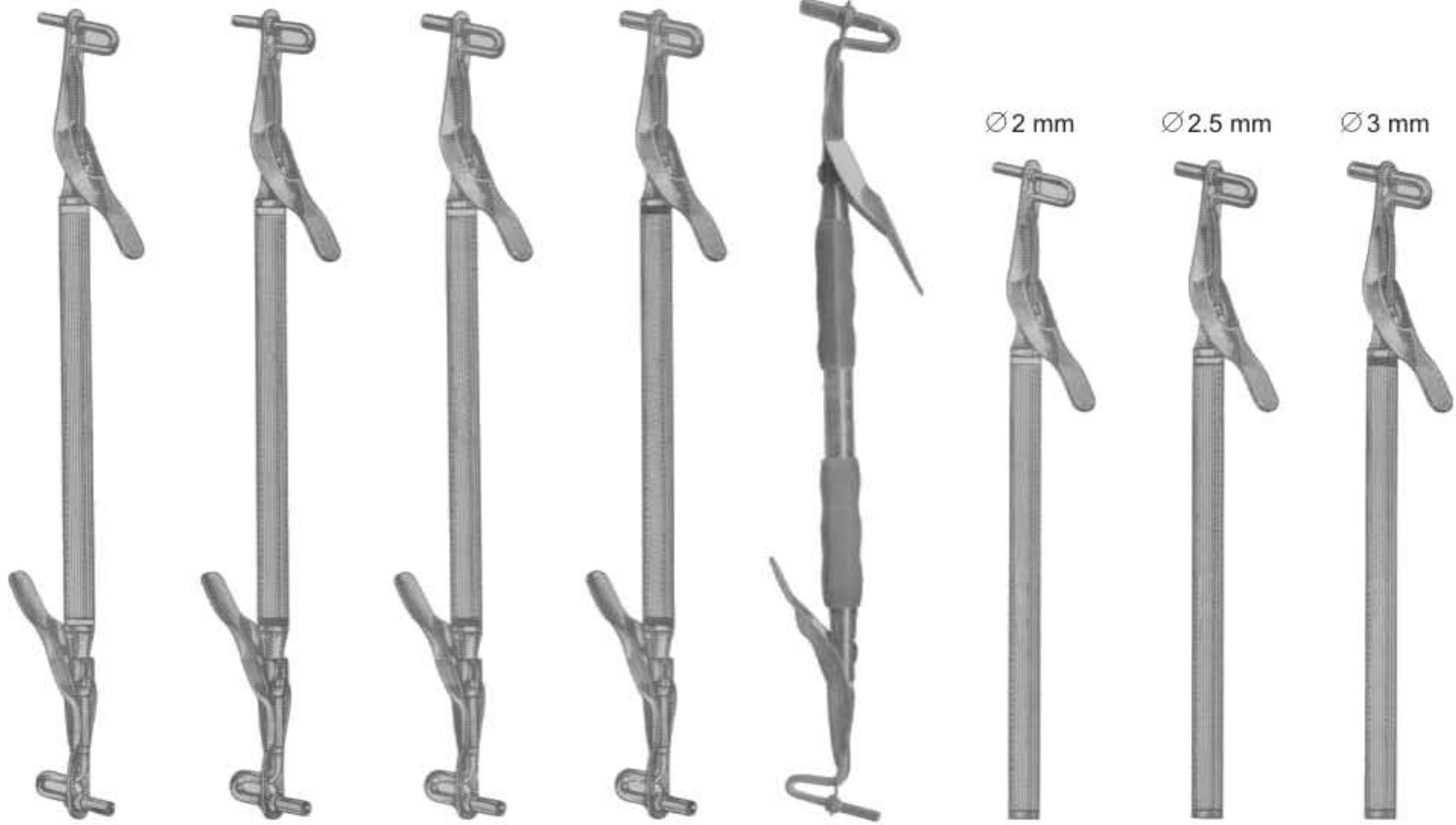

|                                      |                                      |                                     |                                     |   |                                  |                                 |                                 |
|--------------------------------------|--------------------------------------|-------------------------------------|-------------------------------------|---|----------------------------------|---------------------------------|---------------------------------|
| <b>2377</b><br>Medium-Large<br>20 cm | <b>2378</b><br>Medium-Jumbo<br>20 cm | <b>2379</b><br>Large-Jumbo<br>20 cm | <b>2380</b><br>Jumbo-Jumbo<br>20 cm | <b>2381</b><br>Regular-Jumbo<br>Silicon Grip<br>20 cm | <b>2382</b><br>Medium<br>15.5 cm | <b>2383</b><br>Large<br>15.5 cm | <b>2384</b><br>Jumbo<br>15.5 cm |
|--------------------------------------|--------------------------------------|-------------------------------------|-------------------------------------|---|----------------------------------|---------------------------------|---------------------------------|

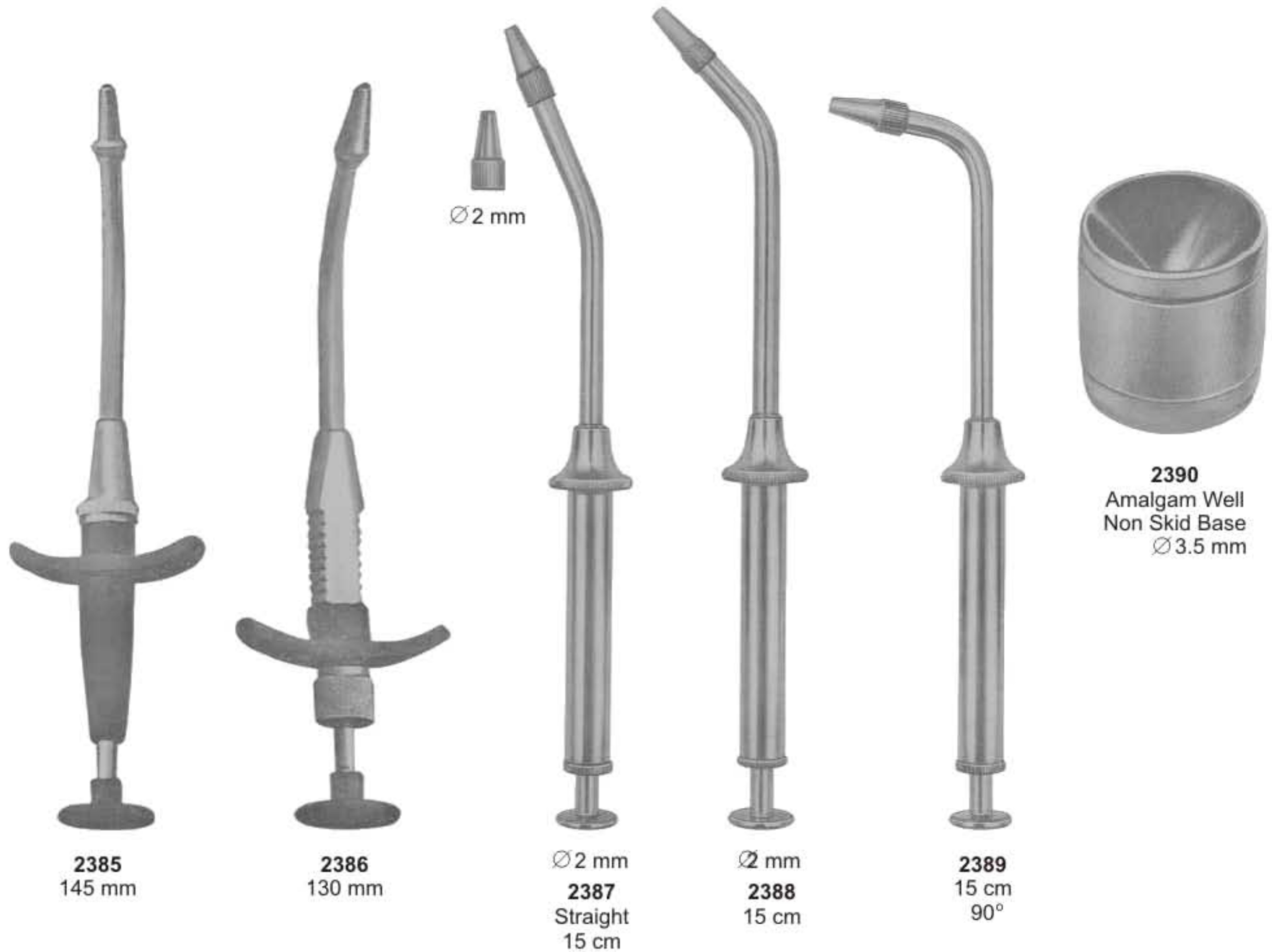

**2385**  
145 mm

**2386**  
130 mm

Ø 2 mm  
**2387**  
Straight  
15 cm

Ø 2 mm  
**2388**  
15 cm

**2389**  
15 cm  
90°

**2390**  
Amalgam Well  
Non Skid Base  
Ø 3.5 mm

Retainers

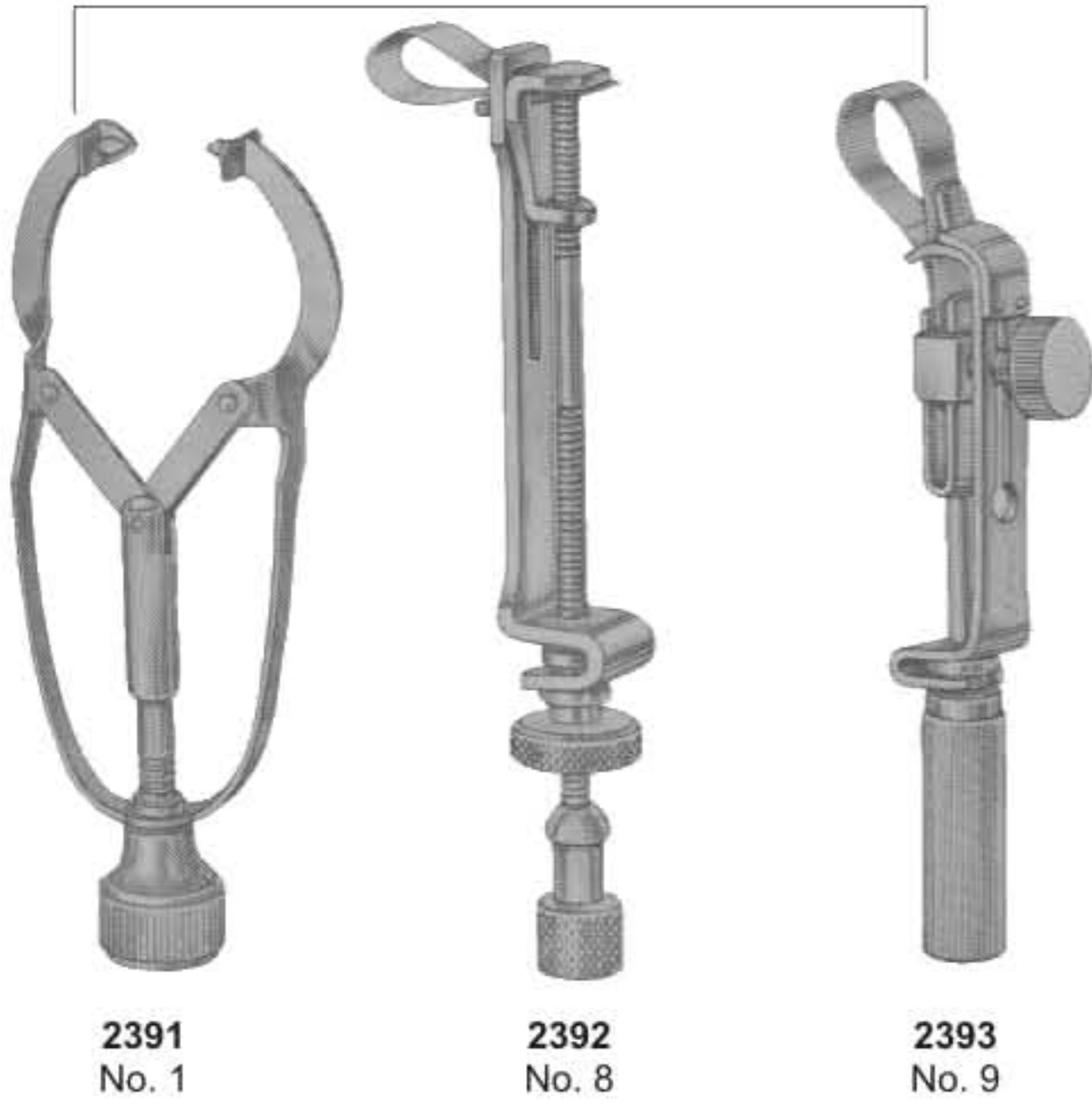

"Tofflemire" Type Retainers



Tofflemire Bands

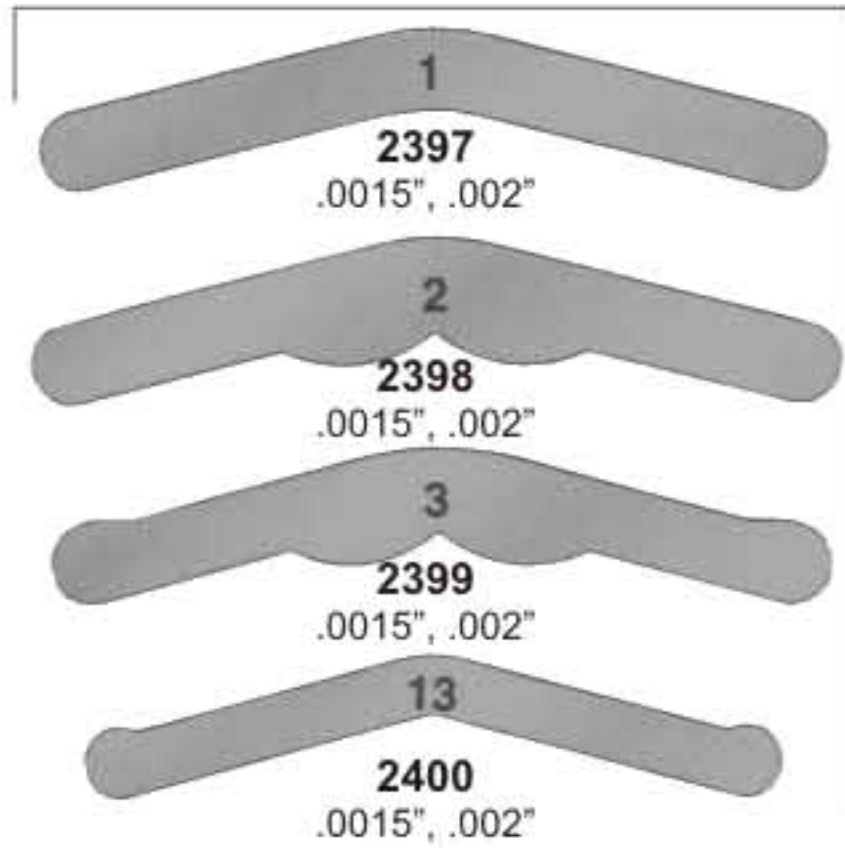

**2401**  
X-Ray Holder  
Small



Napkin Holders



Strip Holders

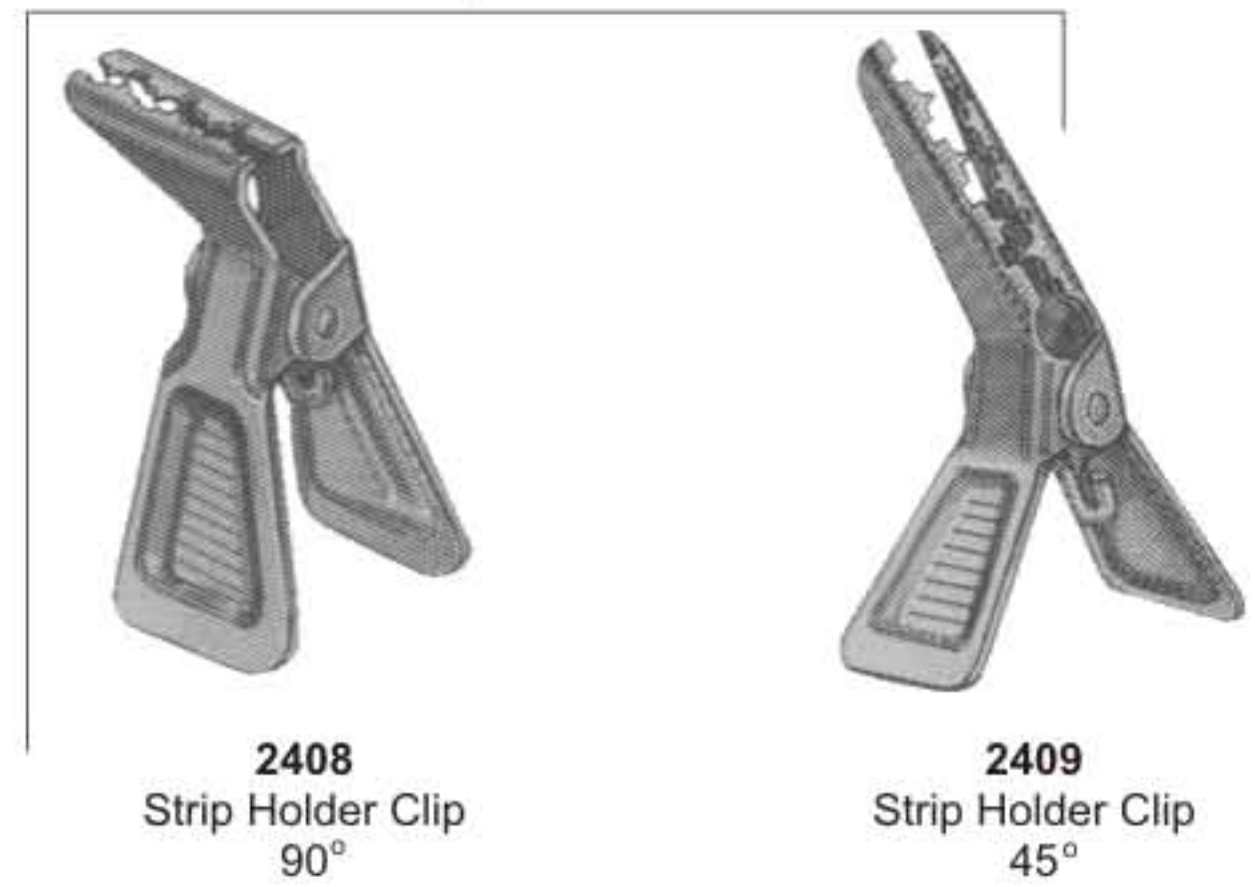

**2405**  
Finger Protector  
Small

**2406**  
Medium

**2407**  
Large



**2410**  
IRORY  
Light weight, 170 mm



**2411**  
BREWER  
175 mm



**2412**  
BREWER  
175 mm



**2413**  
WHITE  
175 mm



**2414**  
IVORY  
170 mm



**2415**  
AINSWORTH  
Rubber Dam Punch  
170 mm



**2416**  
AINSWORTH  
Rubber Dam Punch  
170 mm



**2417**  
AINSWORTH  
Rubber Dam Punch  
170 mm

## Articulating Paper Forceps



**2421**  
MILLER  
Articulating  
Forceps  
15 cm



**2422**  
MILLER  
Articulating  
Forceps  
15 cm

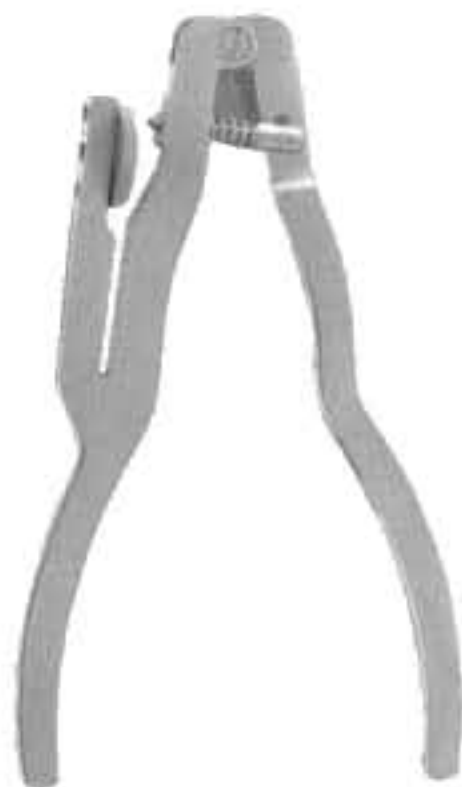

**2418**  
"IV" Type  
Rubber Dam Punch  
160 mm



**2419**  
Plastic Rubber Dam  
Frame 242

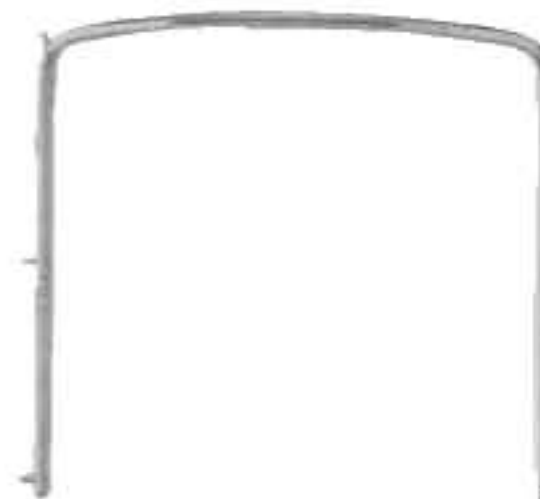

**2420**  
Rubber Dam Holder  
Stainless Steel Pins

## LOWER MOLARS



**2423**  
76D-W3



**2424**  
76D-3



**2429**  
76D-7A



**2430**  
76D-7



**2435**  
76D-12A



**2436**  
76D-13A

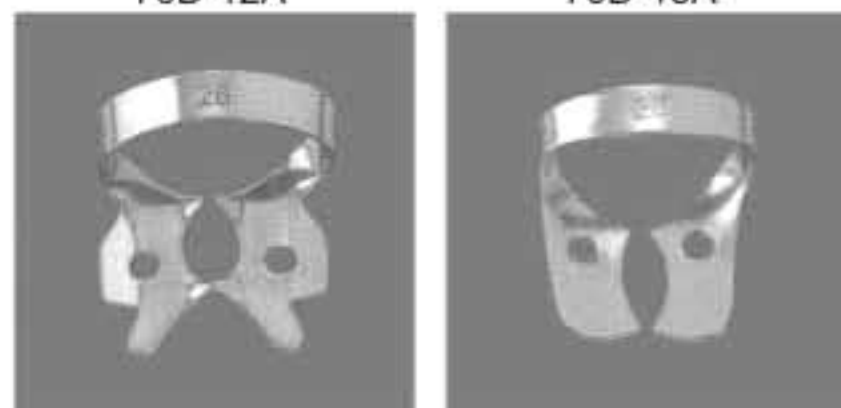

**2441**  
76D-26



**2442**  
76D-28



**2445**  
76D-W8A



**2446**  
76D-8A

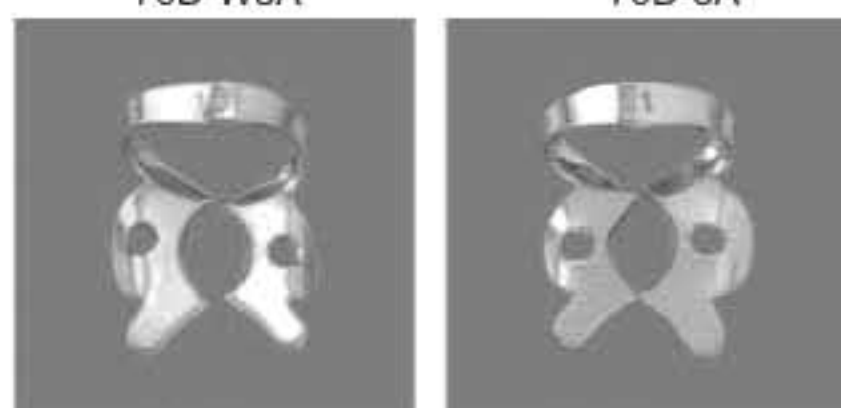

**2447**  
76D-10



**2448**  
76D-11



**2451**  
76D-24



**2452**  
76D-25

## UPPER MOLARS



**2425**  
76D-4



**2426**  
76D-5



**2431**  
76D-8



**2432**  
76D-26N



**2437**  
76D-30



**2438**  
76D-31



**2443**  
76D-201



**2444**  
205

## MOLARS



**2449**  
76D-14



**2450**  
76D-118



**2453**  
76D-27



**2454**  
76D-56



**2455**  
76D-14A

## PREMOLARS



**2427**  
76D-0



**2428**  
76D-1



**2433**  
76D-2A



**2434**  
76D-2



**2439**  
76D-27N



**2440**  
76D-29

## ANTERIOR



**2456**  
76D-00



**2457**  
76D-1A



**2458**  
76D-9



**2459**  
76D-212

4969/CO



4969/F



4969/CV

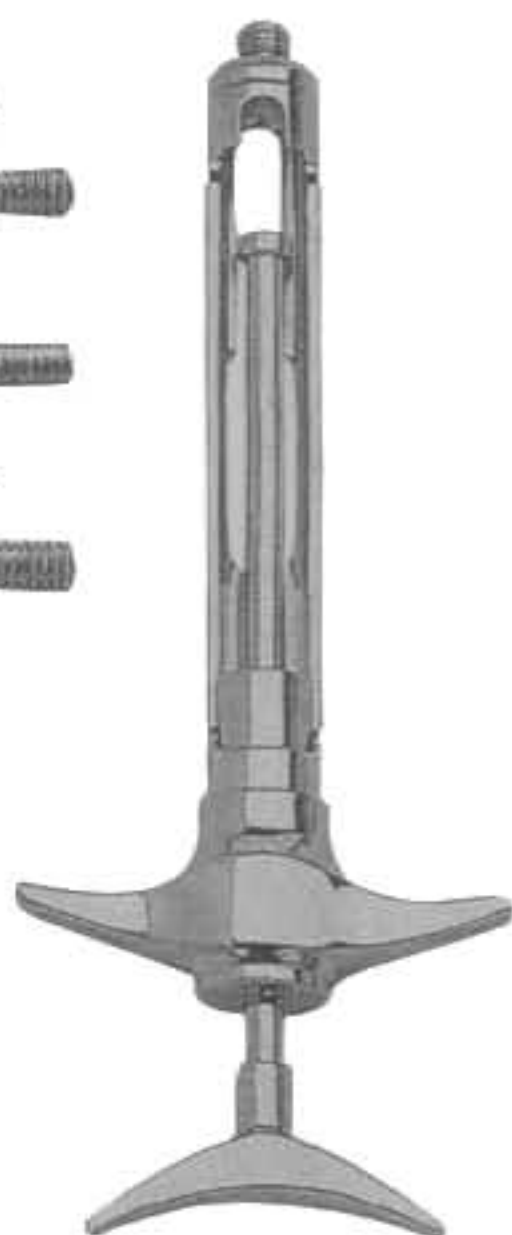

**2460**  
ml 1,8  
EU



**2461**  
ml 1,8  
EU/AM



**2462**  
ml 1,8  
EU/AM



**2463**  
Fig. 1  
ml 1,8  
EU



**2464**  
Fig. 1  
ml 1,8  
EU



**2465**  
SS INOX  
All inox & autoclavable  
black plastic handle  
passive automatic  
aspiration.



**2466**  
Fig. 1  
ml 1,8  
EU/Am



**2467**  
Fig. 1  
ml 1,8  
EU/Am



**2468**  
Fig. 1  
ml 1,8  
EU/Am

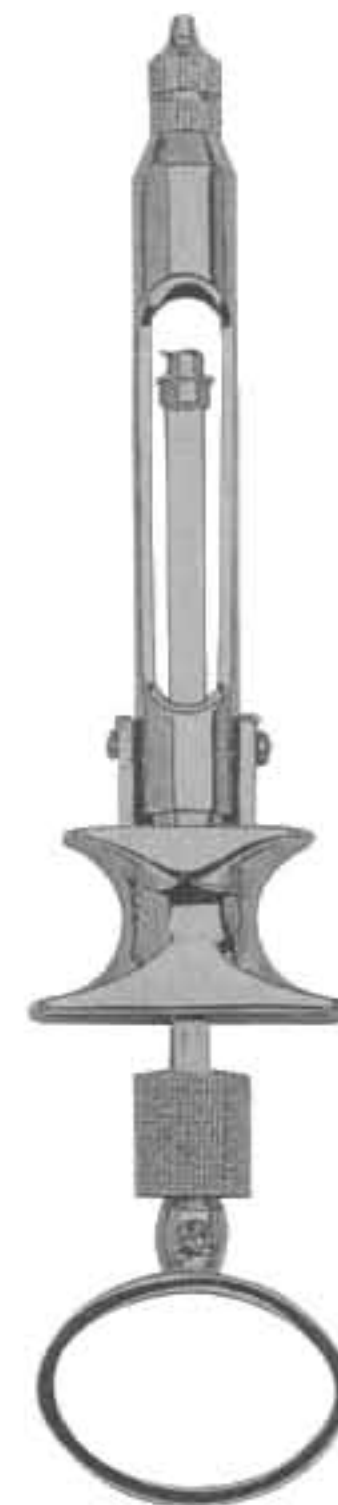

**2469**  
ml 1,2  
EU/Am

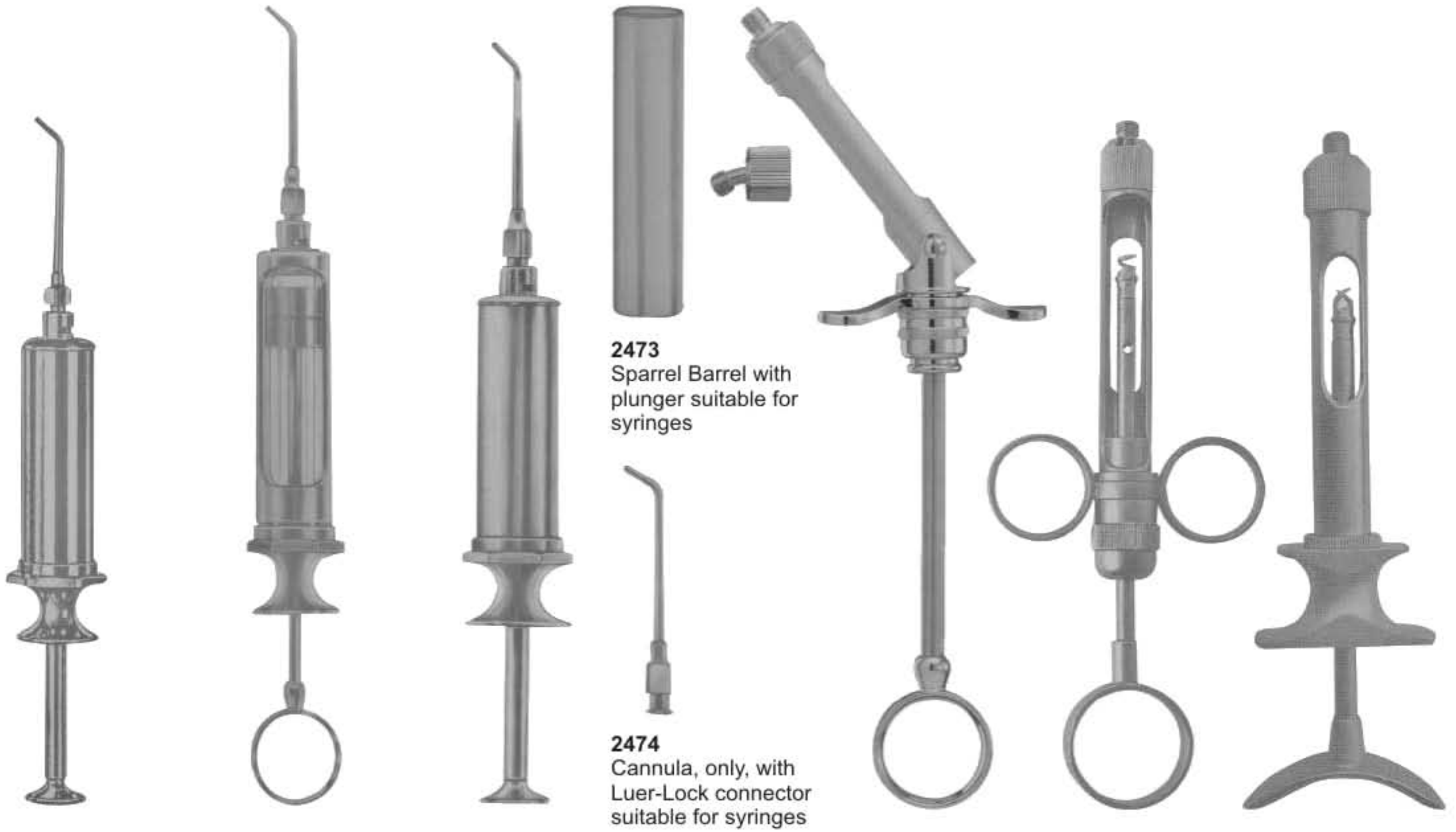

**2470**  
Water Syringe  
complete with  
1 cannula (Lure-Lock)

**2471**  
Water Syringe  
complete with  
1 cannula (Lure-Lock)

**2472**  
Metal Water Syringe  
self-filling, with 1  
cannula (Lure-Lock)

**2473**  
Sprayer Barrel with  
plunger suitable for  
syringes

**2474**  
Cannula, only, with  
Luer-Lock connector  
suitable for syringes

**2475**  
Articulating  
Barrel Syringe

**2476**  
ml 1,8

**2477**  
ml 1,8



**2478**

**2479**

**2480**

**2481**  
Fig. 1  
ml 1,8 EU

**2485**  
Fig. 1  
ml 1,8 EU

**2482**  
Water  
point

**2483**  
Water  
point

**2484**  
Water  
point

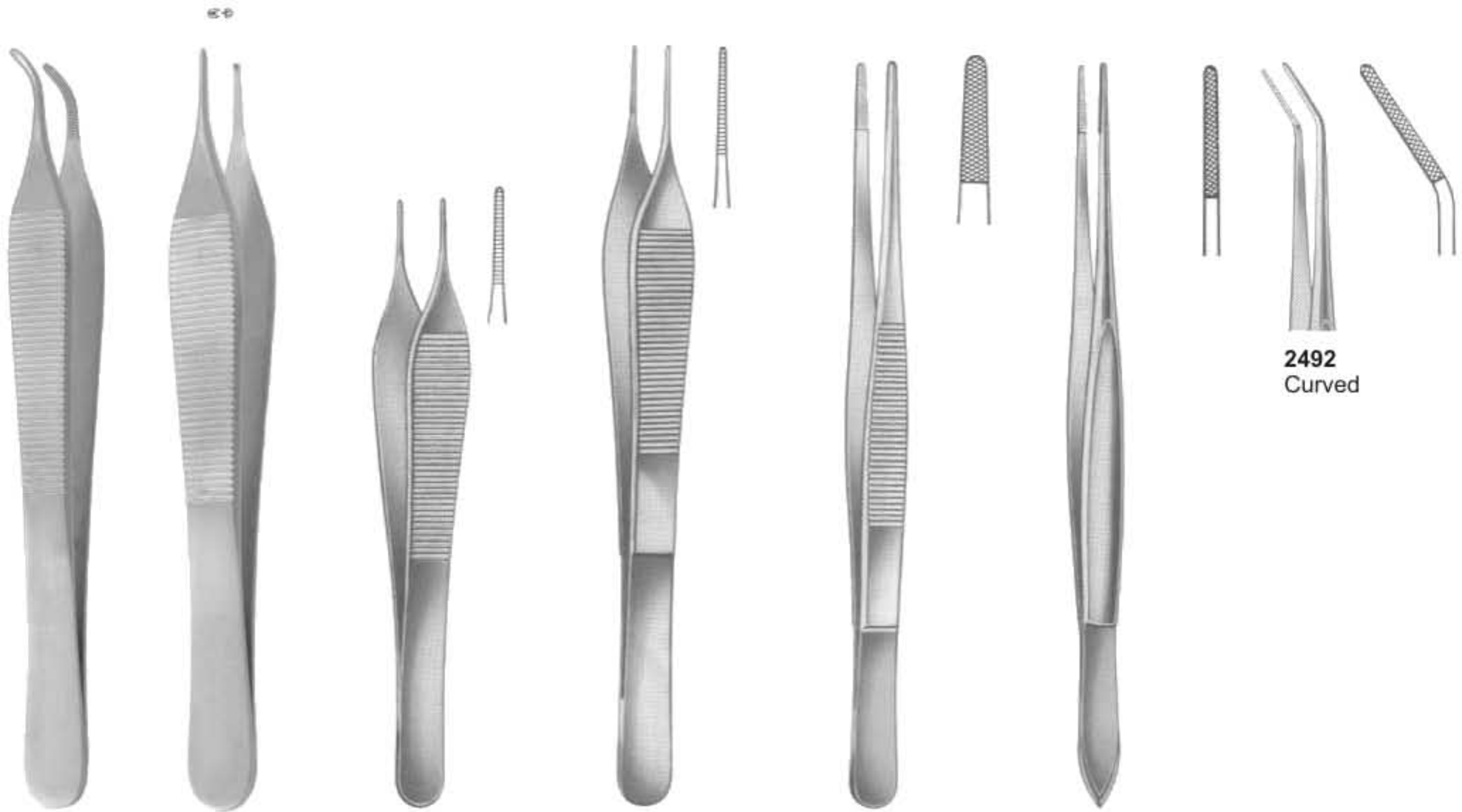

**2486**  
ADSON  
Curved 14 cm

**2487**  
ADSON  
1X2 / 12 cm

**2488**  
ADSON  
12 cm

**2489**  
MICRO ADSON  
15 cm

**2490**  
STANDARD  
14,18,25 cm

**2491**  
CUSHING  
18 cm

**2492**  
Curved

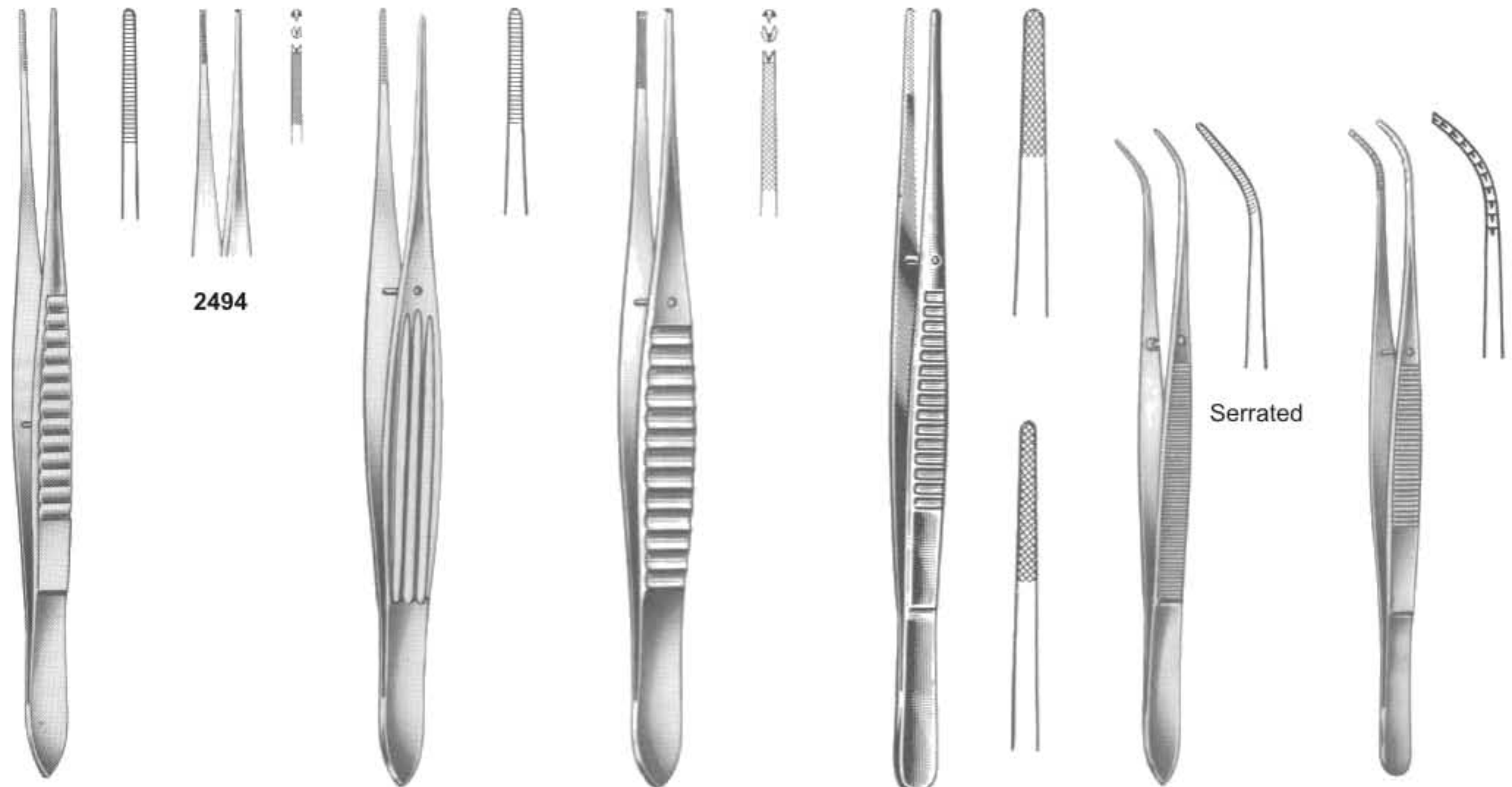

**2493**  
SELECT  
15,18,20 cm

**2494**

**2495**  
MCINDOE  
15 cm

**2496**  
GILLIES  
15 cm

**2497**  
WAUGH  
15,20 cm

Serrated

**2498**  
PERRY  
13 cm

**2499**  
KOPP  
15.5 cm





**2500**  
COLLEGE  
15 cm



smooth



**2501**  
COLLEGE  
15 cm



serrated



**2502**  
COLLEGE  
15 cm



smooth



**2503**  
COLLEGE  
15 cm



serrated



**2504**  
COLLEGE  
15 cm



smooth



**2505**  
COLLEGE  
15 cm



serrated



**2506**  
COLLEGE  
15 cm



smooth



**2507**  
COLLEGE  
15 cm



serrated



**2508**  
MERIAM  
16 cm



smooth



**2509**  
MERIAM  
16 cm



serrated



**2510**  
MERIAM  
16 cm



smooth



**2511**  
MERIAM  
16 cm1



serrated



**2512**  
MERIAM  
16 cm



smooth



**2513**  
MERIAM  
16 cm



serrated



**2514**  
MERIAM  
16 cm



smooth



**2515**  
MERIAM  
16 cm



serrated

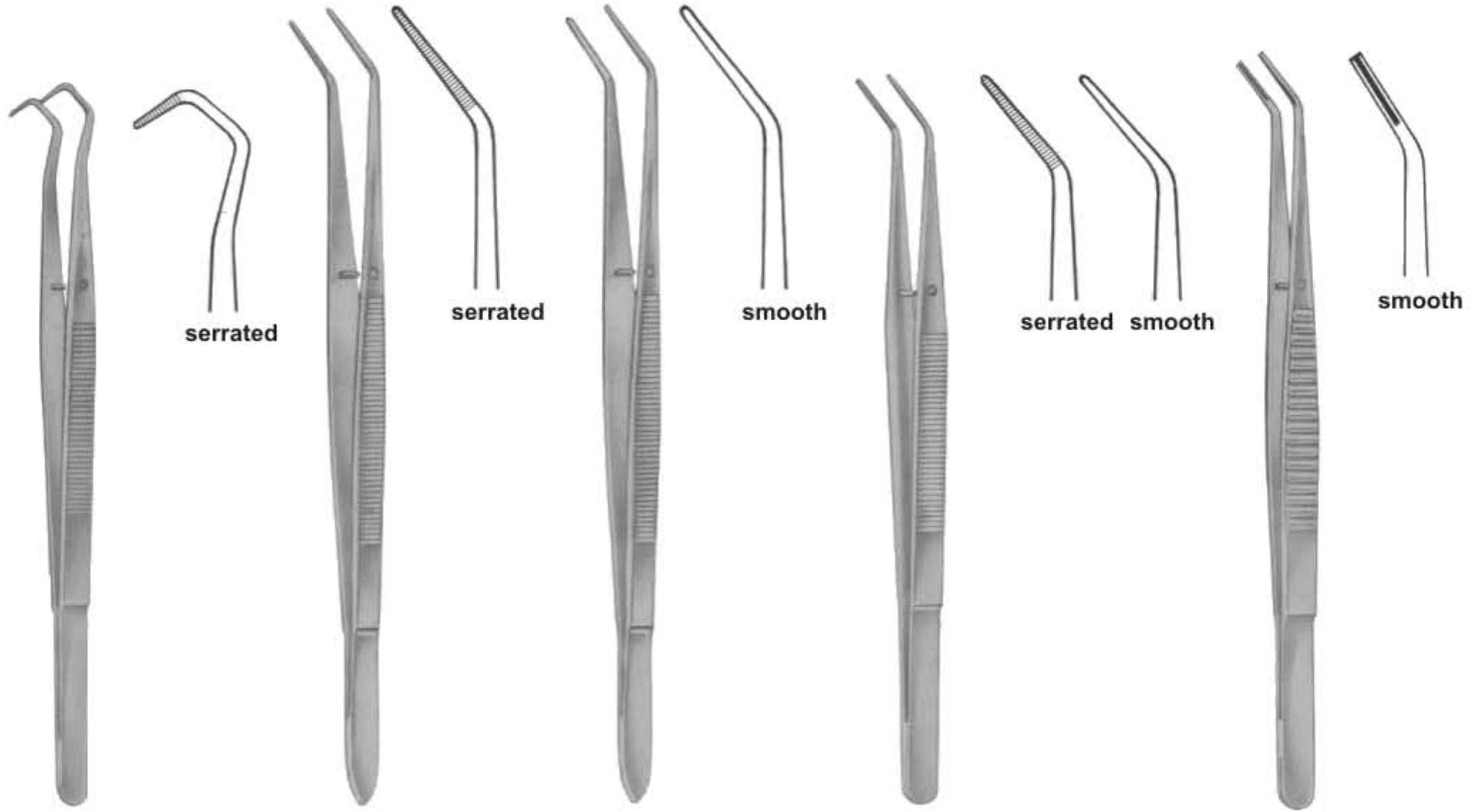

**2516**  
COLLEGE  
14.5 cm, 5<sup>3</sup>/<sub>4</sub>"

**2517**  
FLAGG  
16 cm, 6<sup>1</sup>/<sub>4</sub>"

**2518**  
FLAGG  
16 cm, 6<sup>1</sup>/<sub>4</sub>"

**2519**  
LANDGRAF  
15 cm, 6"

**2520**  
15.5 cm, 6<sup>1</sup>/<sub>8</sub>"

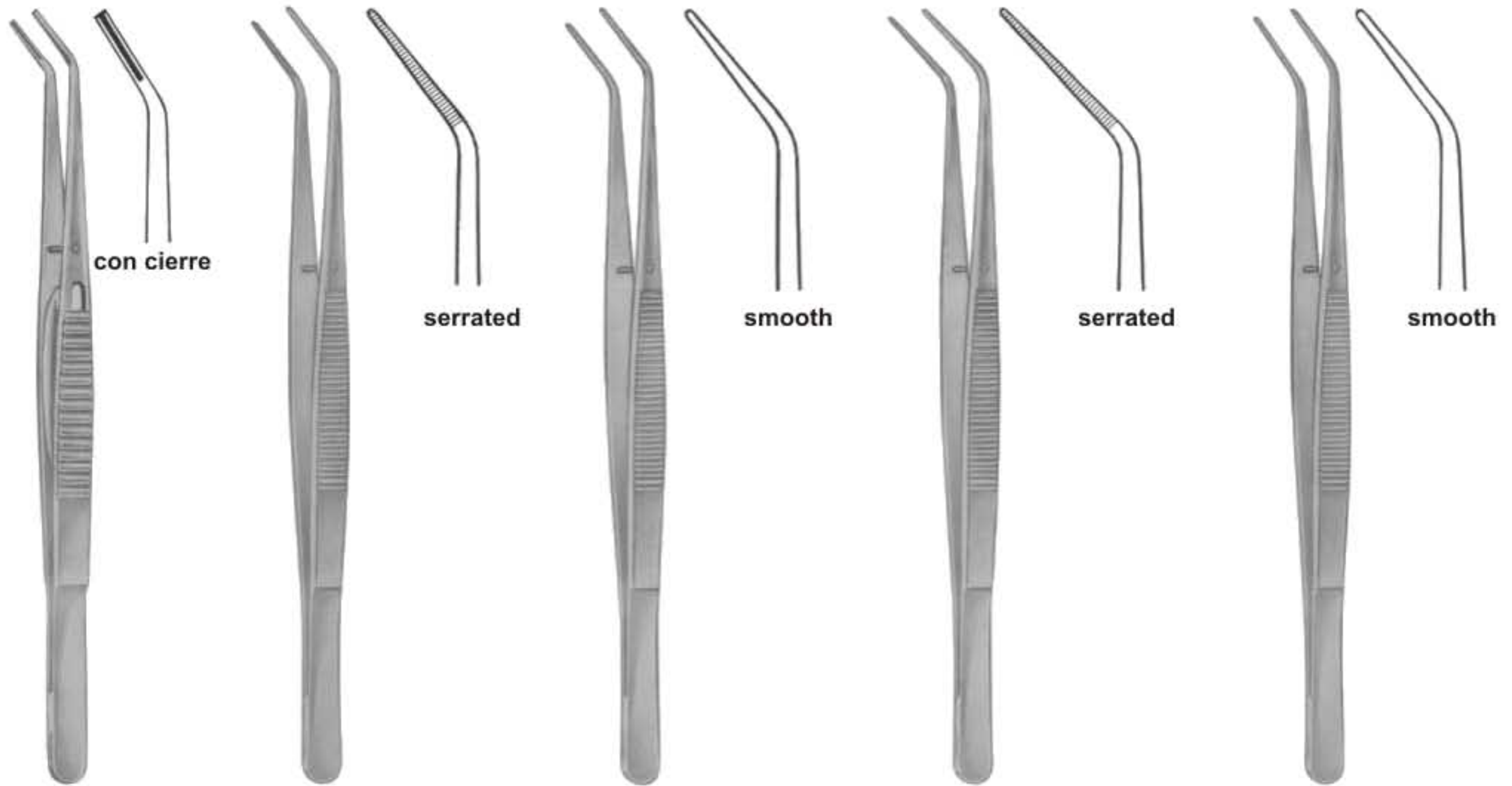

**2521**  
15.5 cm, 6<sup>1</sup>/<sub>8</sub>"

**2522**  
LONDON-COLLEGE  
15 cm, 6"

**2523**  
LONDON-COLLEGE  
15 cm, 6"

**2524**  
LONDON-COLLEGE  
15 cm, 6"

**2525**  
LONDON-COLLEGE  
15 cm, 6"



**2526**  
LONDON-COLLEGE  
15 cm, 6"



**2527**  
LONDON-COLLEGE  
15 cm, 6"



con cierre



**2528**  
MERIAM  
16 cm, 6 1/4"



serrated



smooth



**2529**  
ALLEN  
18 cm, 7 1/8"



**2530**  
ALBRECHT  
16 cm, 6 1/4"

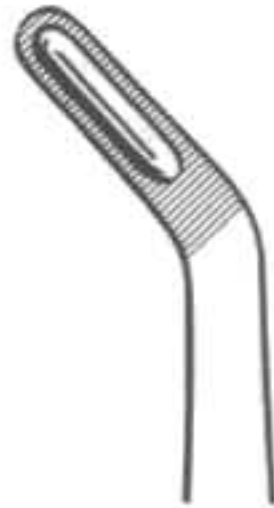

**2531**  
ALBRECHT  
16 cm, 6 1/4"



**2532**  
16 cm, 6 1/4"



**2533**  
16 cm, 6 1/4"



**2534**  
16 cm, 6 1/4"



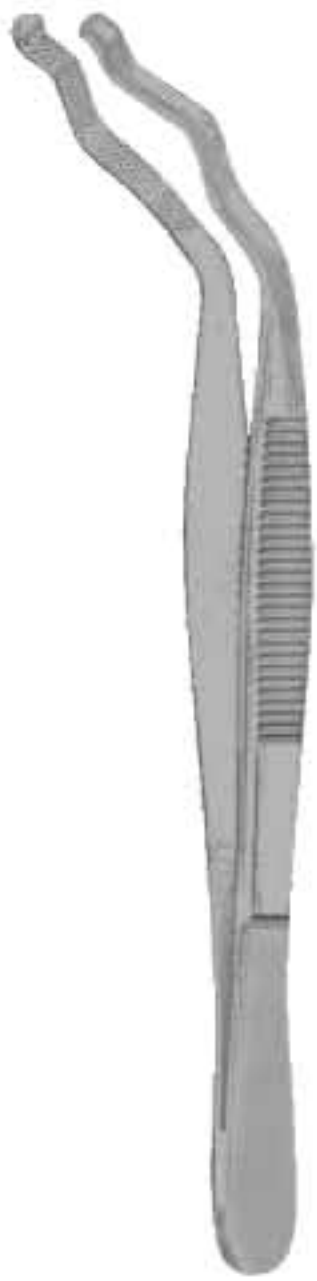

**2535**  
DAVIS  
6"



**2536**  
Grasping Forceps  
6 1/4"



**2537**  
Mesh Bur & Diamond Holder  
Large, 2 1/8" Diameter



**2538**  
Soldering Tweezers  
6 1/4"



**2539**  
Narrow Fine  
4 3/4"



**2540**  
Super Fine  
4 3/8"



**2541**  
Fine Curved  
4 1/2"



**2542**  
Bonding Bracket  
Holder  
136 mm



**2543**  
Bonding Bracket  
Holder  
135 mm







**2544**  
Bonding Bracket  
Holder  
135 mm

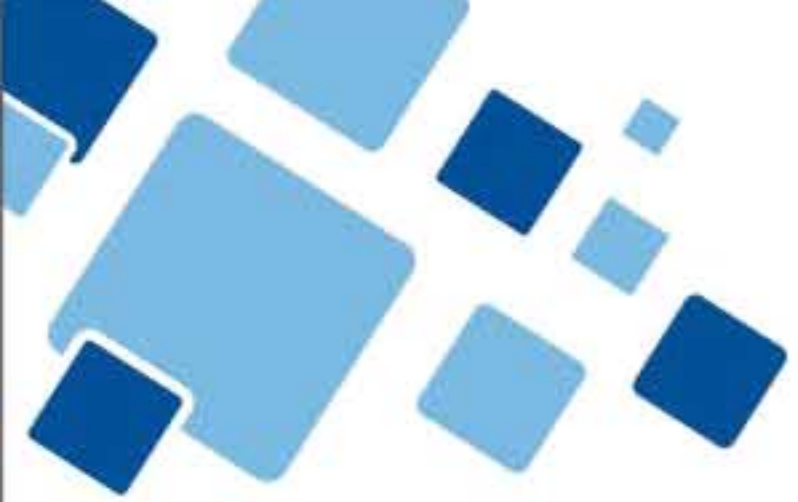

**2545**  
Bonding Bracket  
Holder  
140 mm



-  Endodontic Forceps
-  Tissue Forceps
-  Retractors
-  Mouth Gags

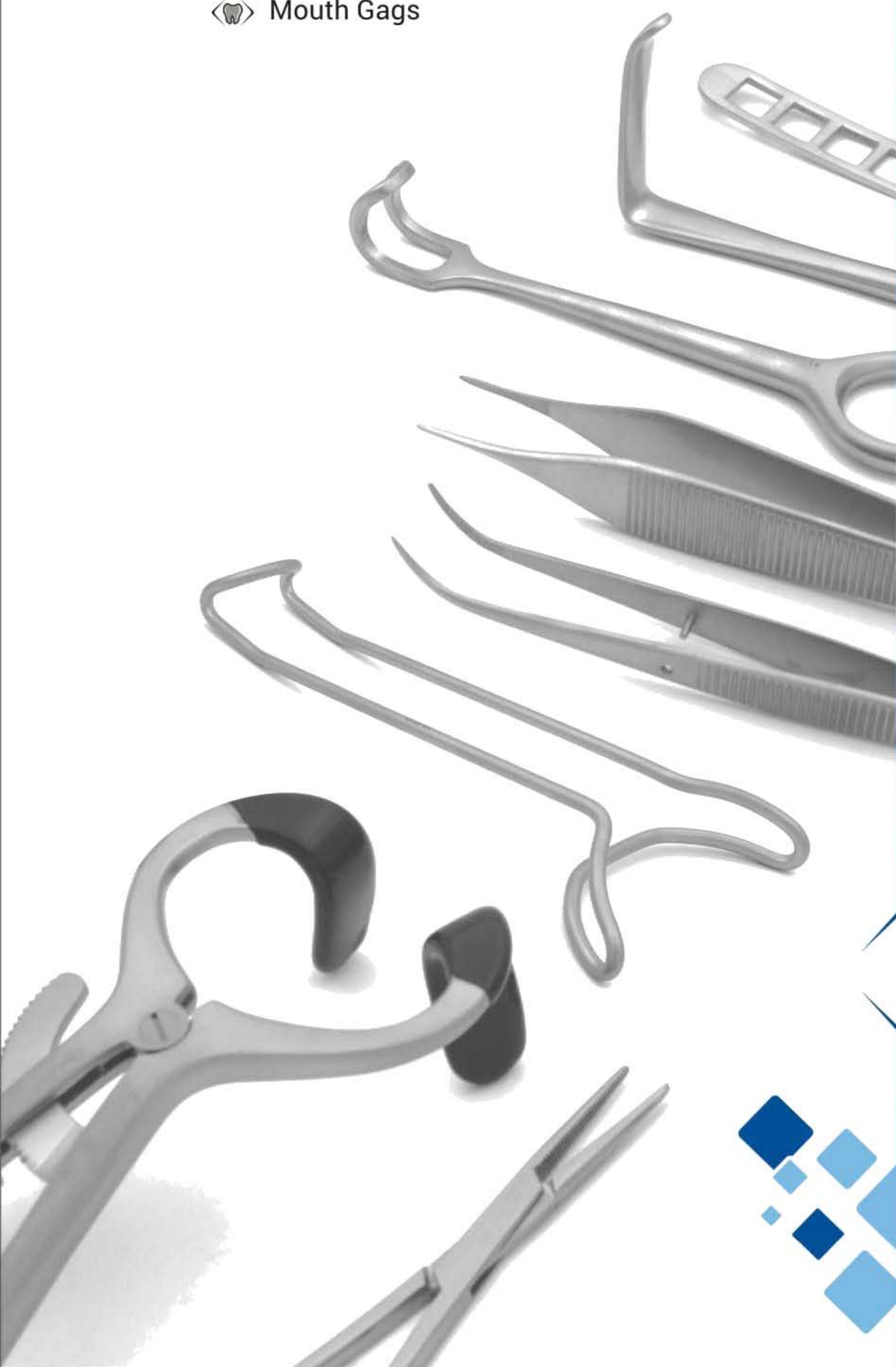

**06**  
SECTION





**2546**  
Endo Forceps  
4 3/4"



**2547**  
PEETS Forceps  
4 3/4", Useful For  
Removing Broken  
Instruments

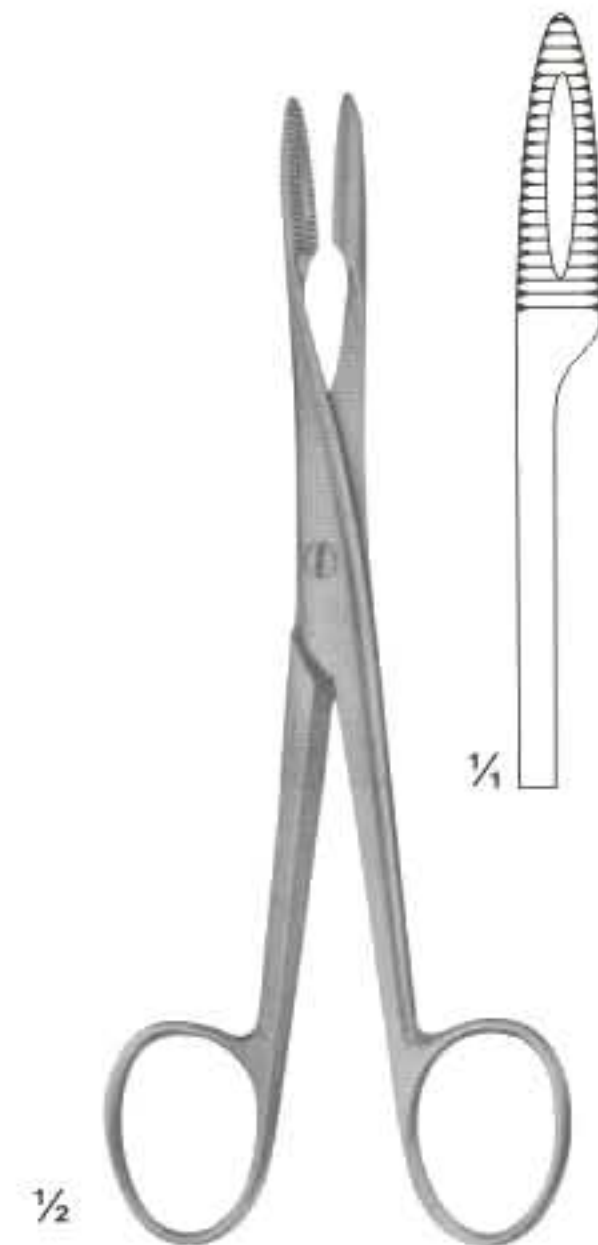

**2548**  
Without Ratchet  
145 mm

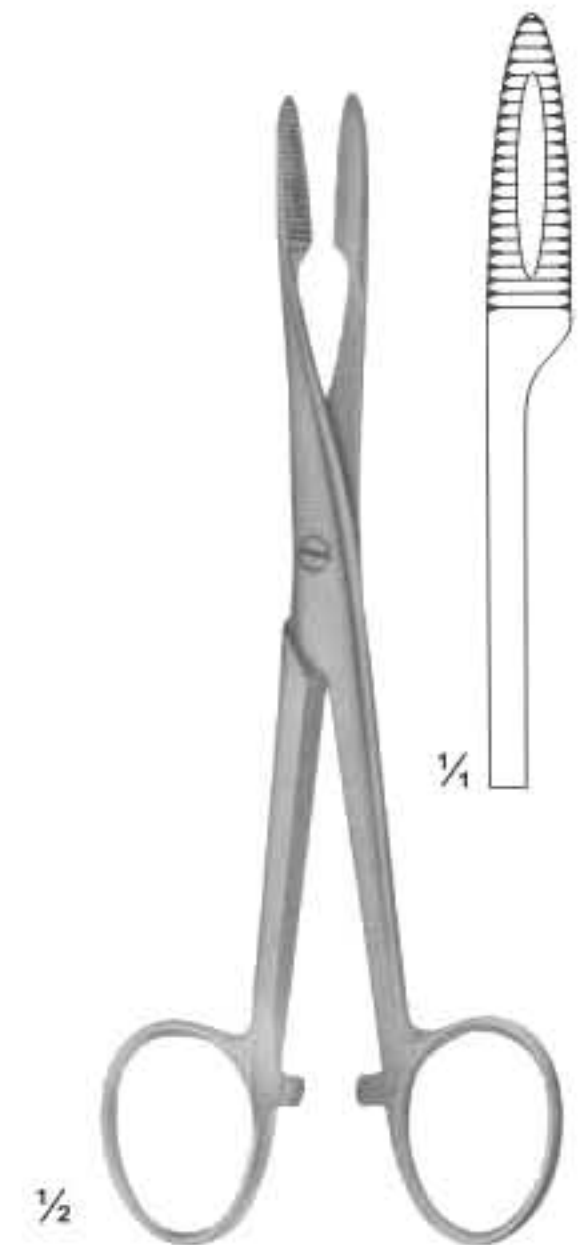

**2549**  
With Ratchet  
145 mm

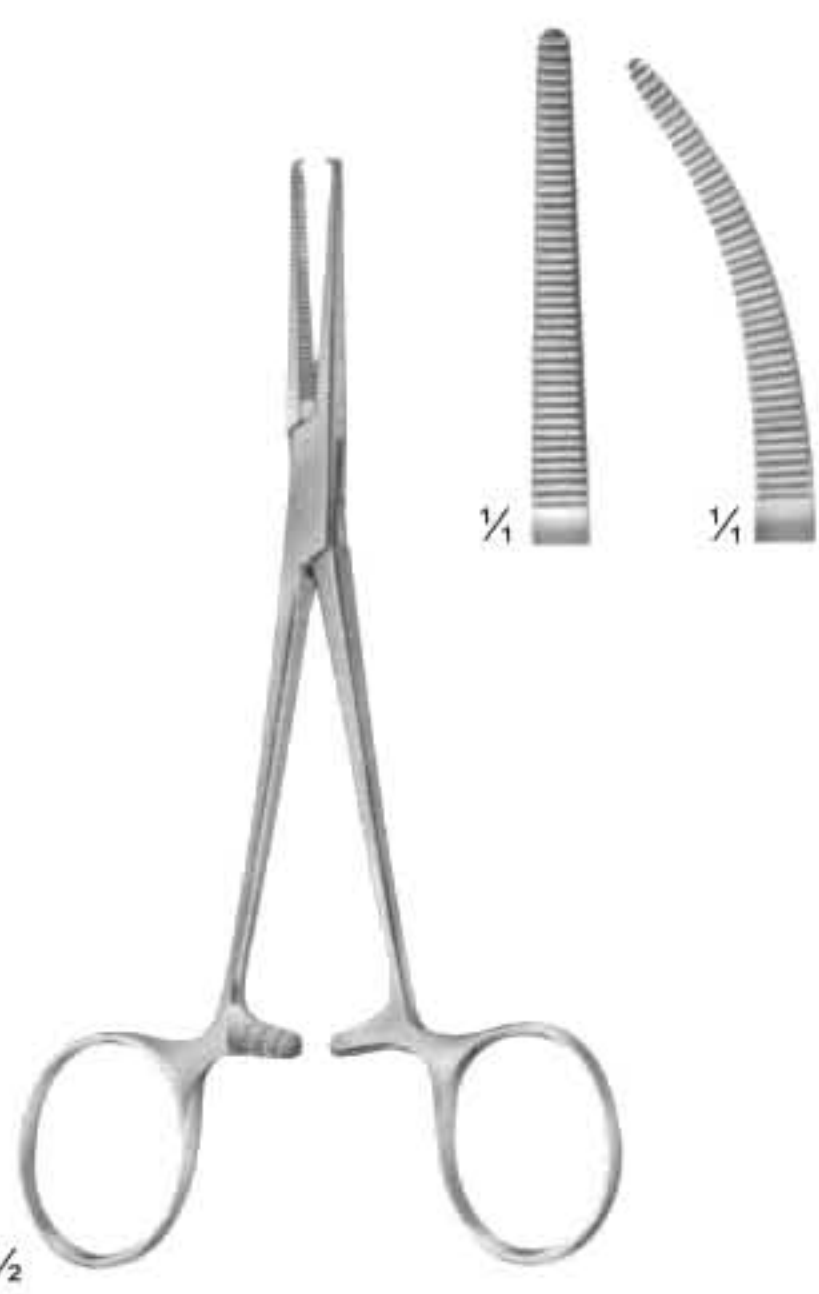

**2550**  
CRILE  
140 mm

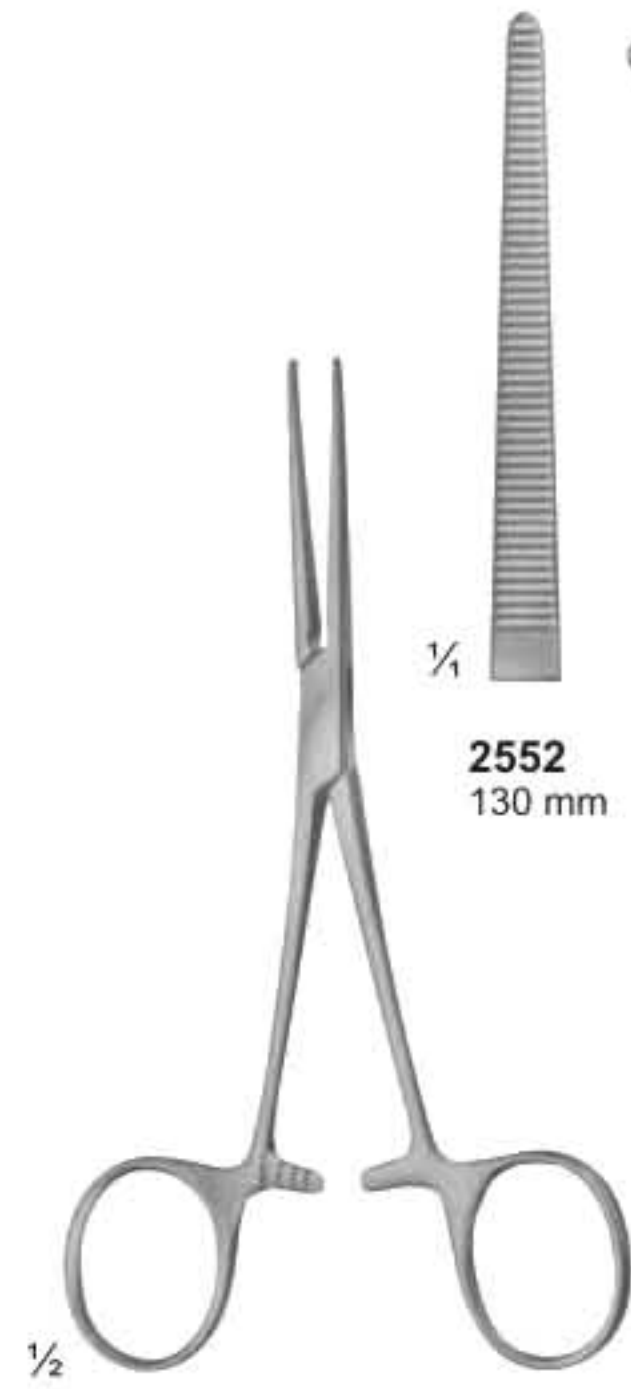

**2551**  
PEAN  
Slender type

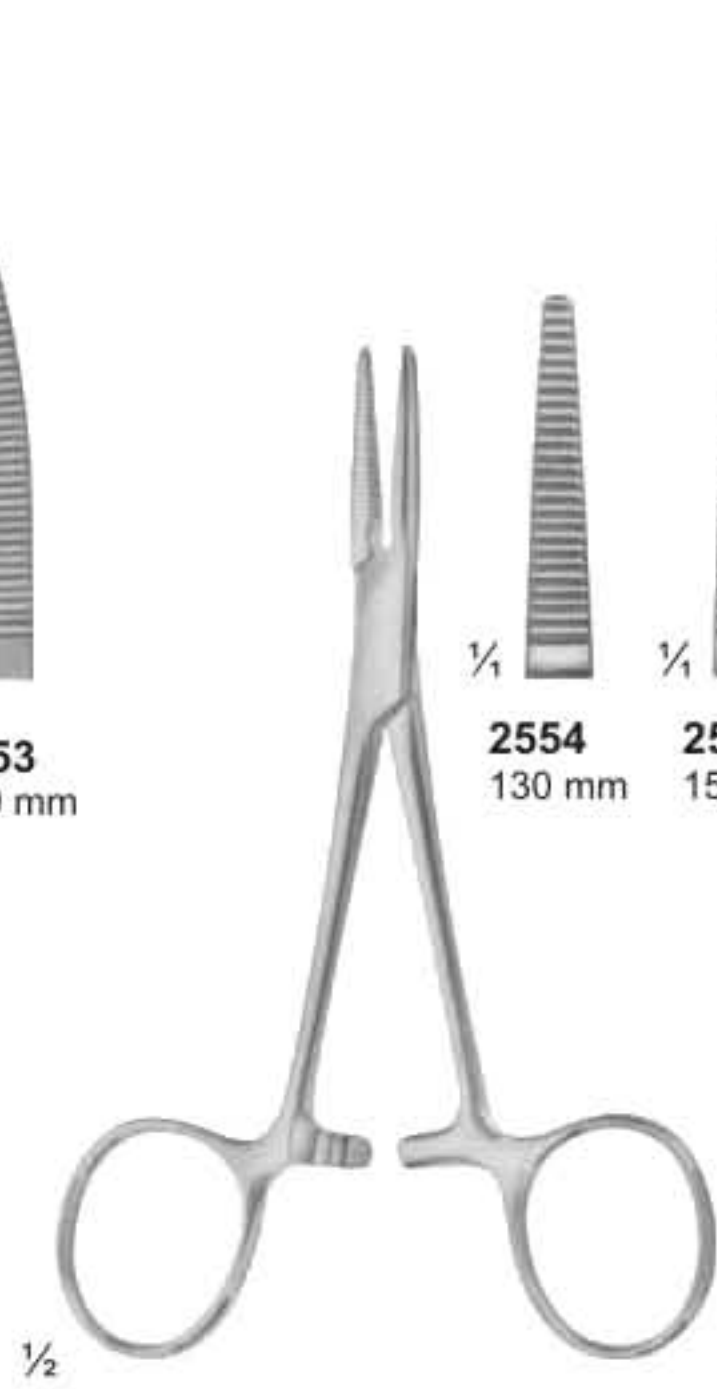

**2554**  
SPENCER-WELLS

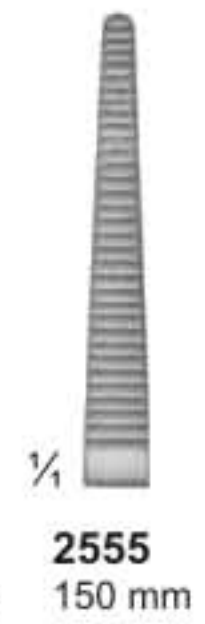
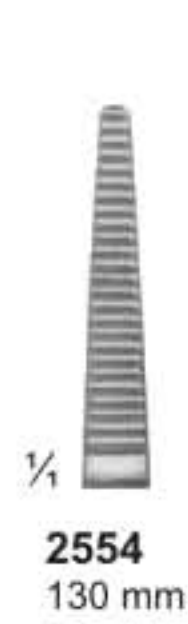
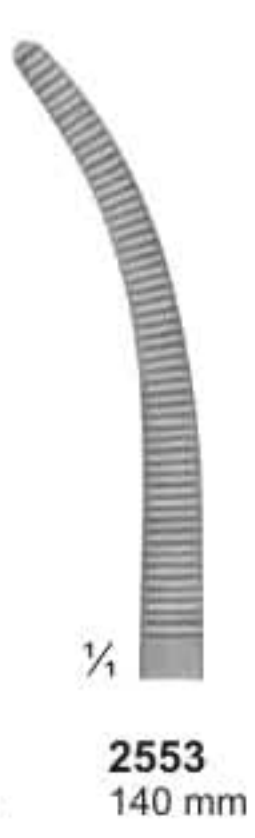
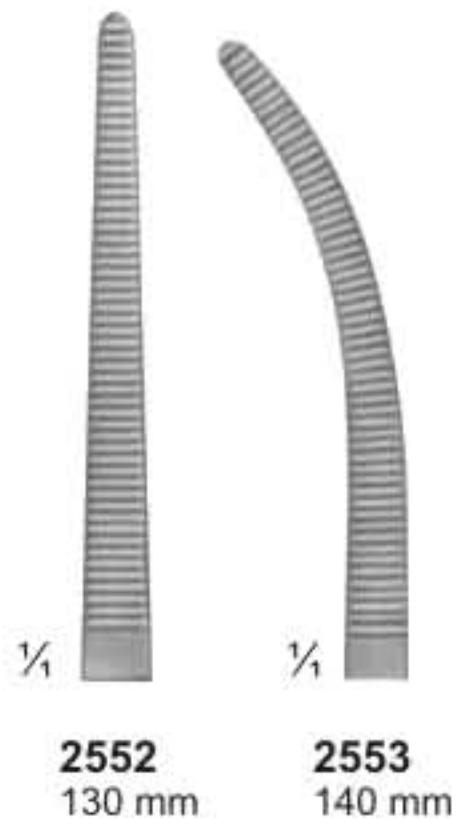



**2558**  
BABY-ALLIS  
5", Straight  
4x5 teeth extra delicate

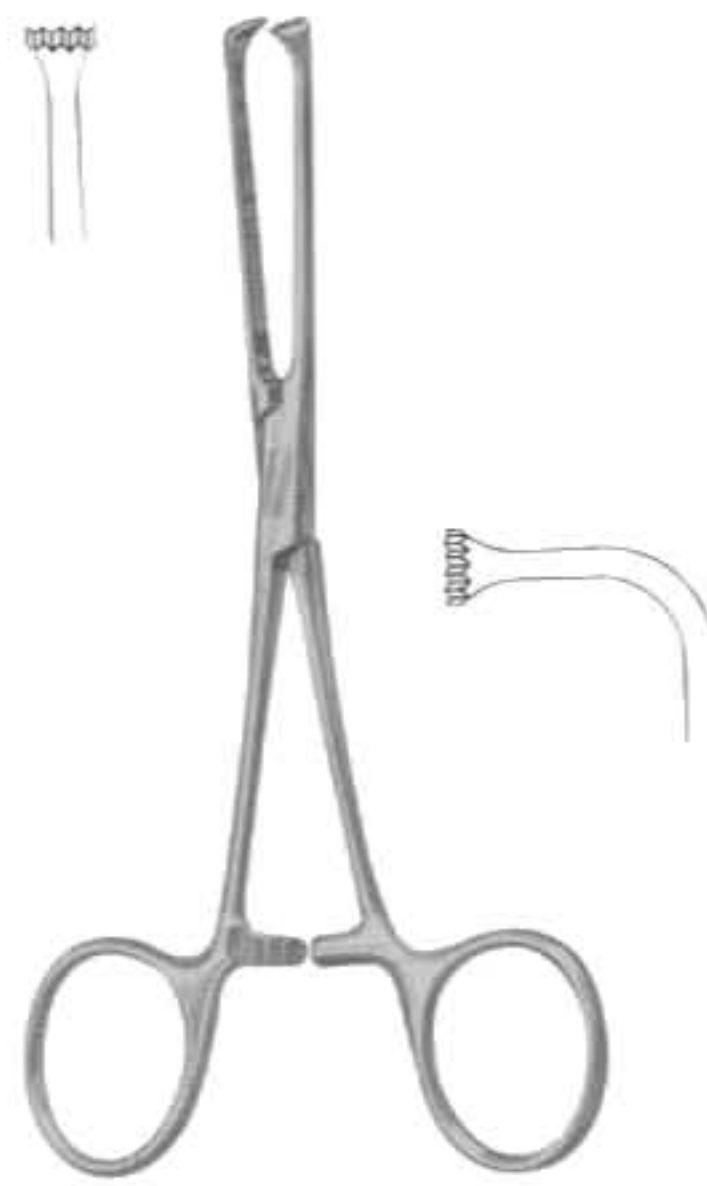

**2559**  
ALLIS  
6", Straight  
4x5 teeth extra delicate

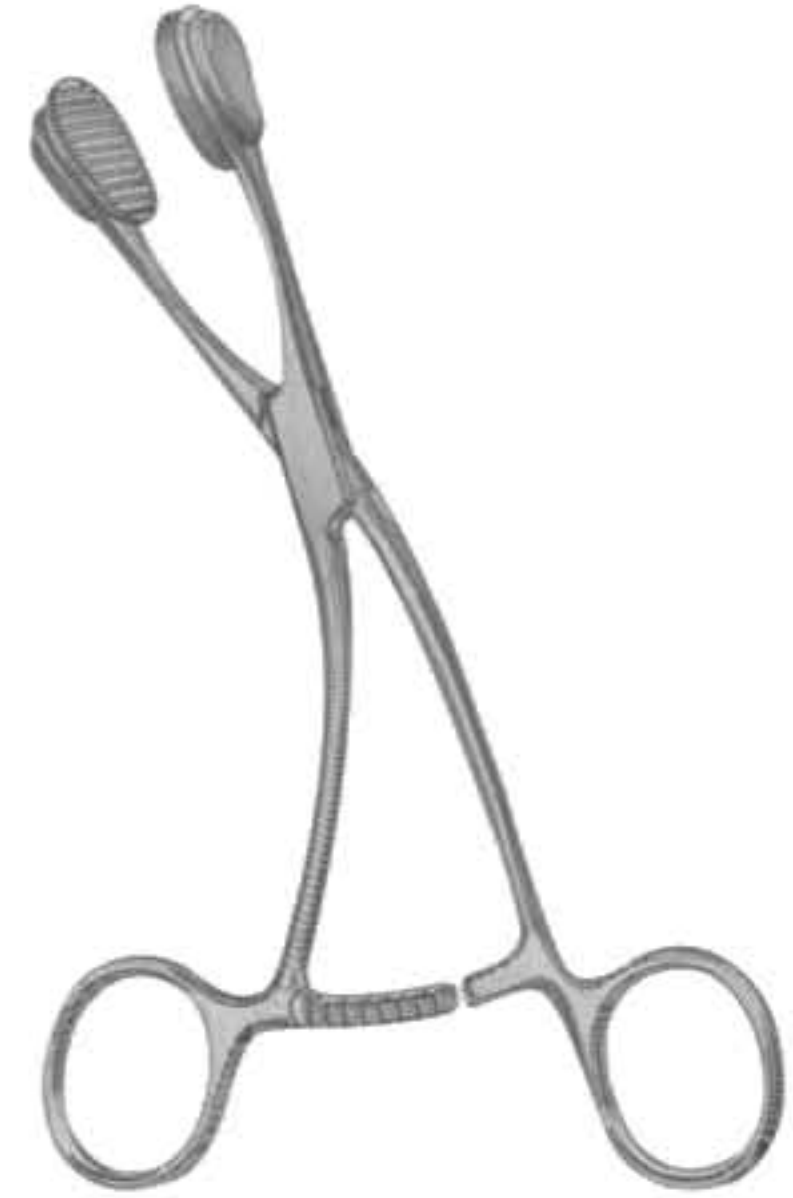

**2560**  
ALLIS  
6", Straight  
4x5 teeth extra delicate



**2561**  
1x2 teeth  
6"



**2562**  
SEMKIN  
6", Straight,  
1x2 teeth



**2563**  
ADSON  
4 3/4"  
1x2 teeth



**2564**  
BROWN-ADSON  
4 3/4"  
7x7 teeth



**2565**  
BROWN  
6"  
8x8 teeth



**2566**  
RUSSIAN  
6"  
8x8 teeth



**2567**  
Extra-Delicate,  
Straight, 4"  
1x2 teeth





**2568**  
HALSTED-MOSQUITO  
Straight, Curved, 5"



**2569**  
HALSTED-MOSQUITO  
Straight, Curved, 5"  
1x2 teeth



**2570**  
HALSTED-MOSQUITO  
Jaws 45 Angled on Flat, 5"  
Extra Delicate



**2571**  
KELLY  
5 1/2", Straight



**2572**  
JONES  
3 1/2"



**2573**  
BACKHAUS  
3 1/2"



**2574**  
BACKHAUS  
5 1/4"

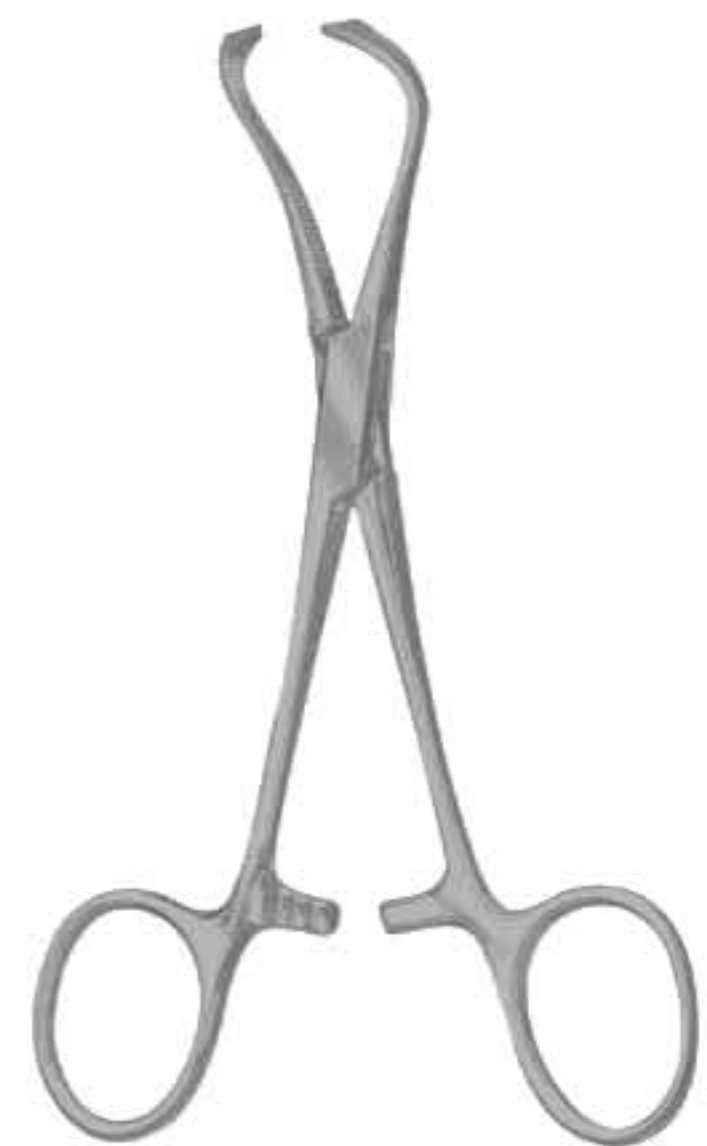

**2575**  
LORNA  
Non Perforated  
3 1/2"



**2576**  
DENHART



**2577**  
DENHART  
Mouth Gag With  
Silicon Inserts,  
Interchangeable  
Size: 125 mm

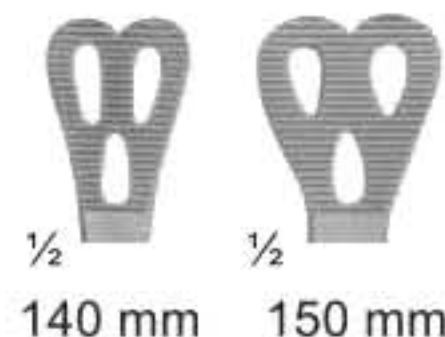

**2578**  
WIEDER  
Tongue depressor  
**2579** 140mm  
**2580** 150mm

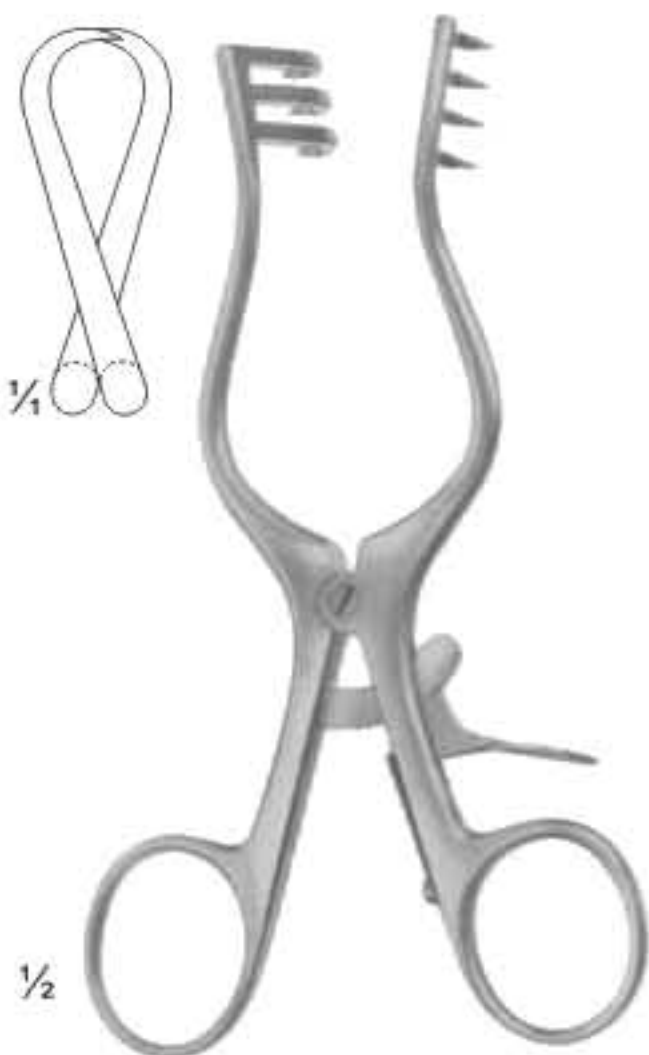

**2583**  
WEITLANER  
Sharp  
130 mm

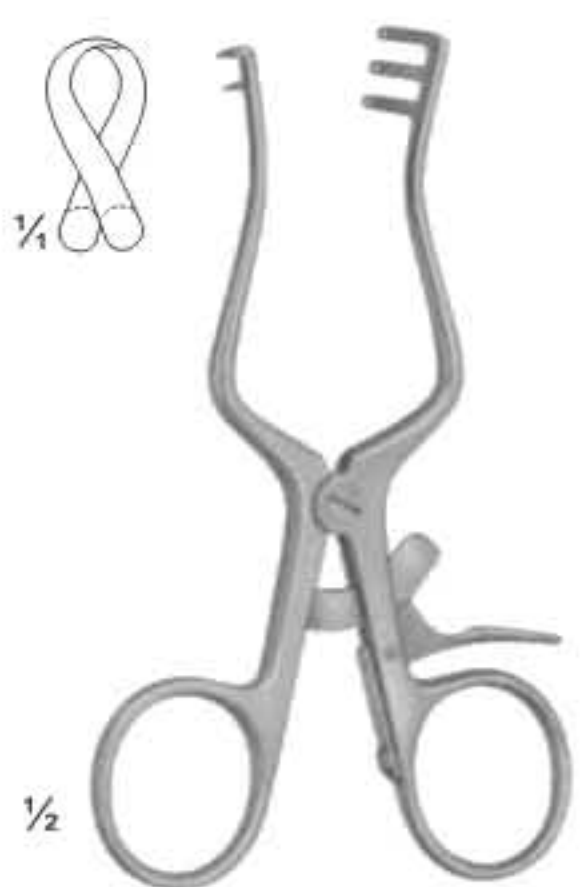

**2584**  
WEITLANER  
Sharp  
110 mm

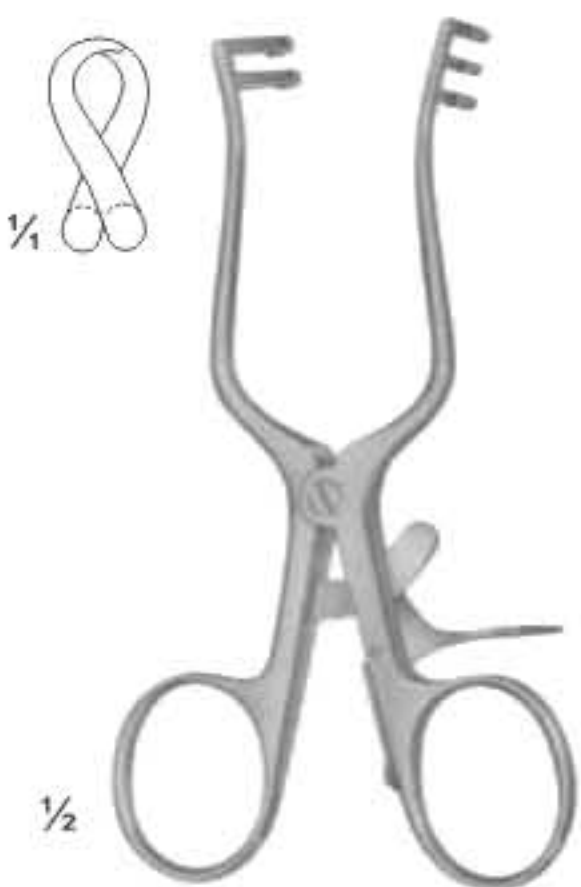

**2585**  
WEITLANER  
Semi-Sharp  
110 mm



**2581**  
TOBOLD  
Tongue depressor  
Size: 145 mm

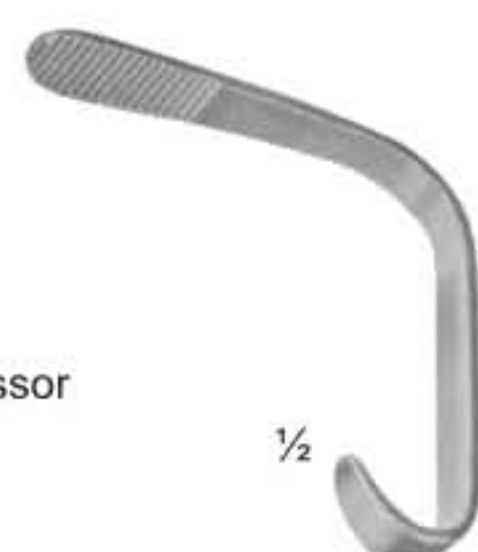

**2582**  
ANDREW  
Tongue depressor  
Size: 110 mm



**2586**  
MOLT  
Pediatric



**2587**  
MOLT  
Child



**2588**  
MOLT  
Adult



**2589**  
FERGUSSON-ACKLAND  
Mouth Gag  
Size: 145 mm



**2590**  
ROSER KOENIG  
Mouth Gag  
Size: 160mm / 185mm

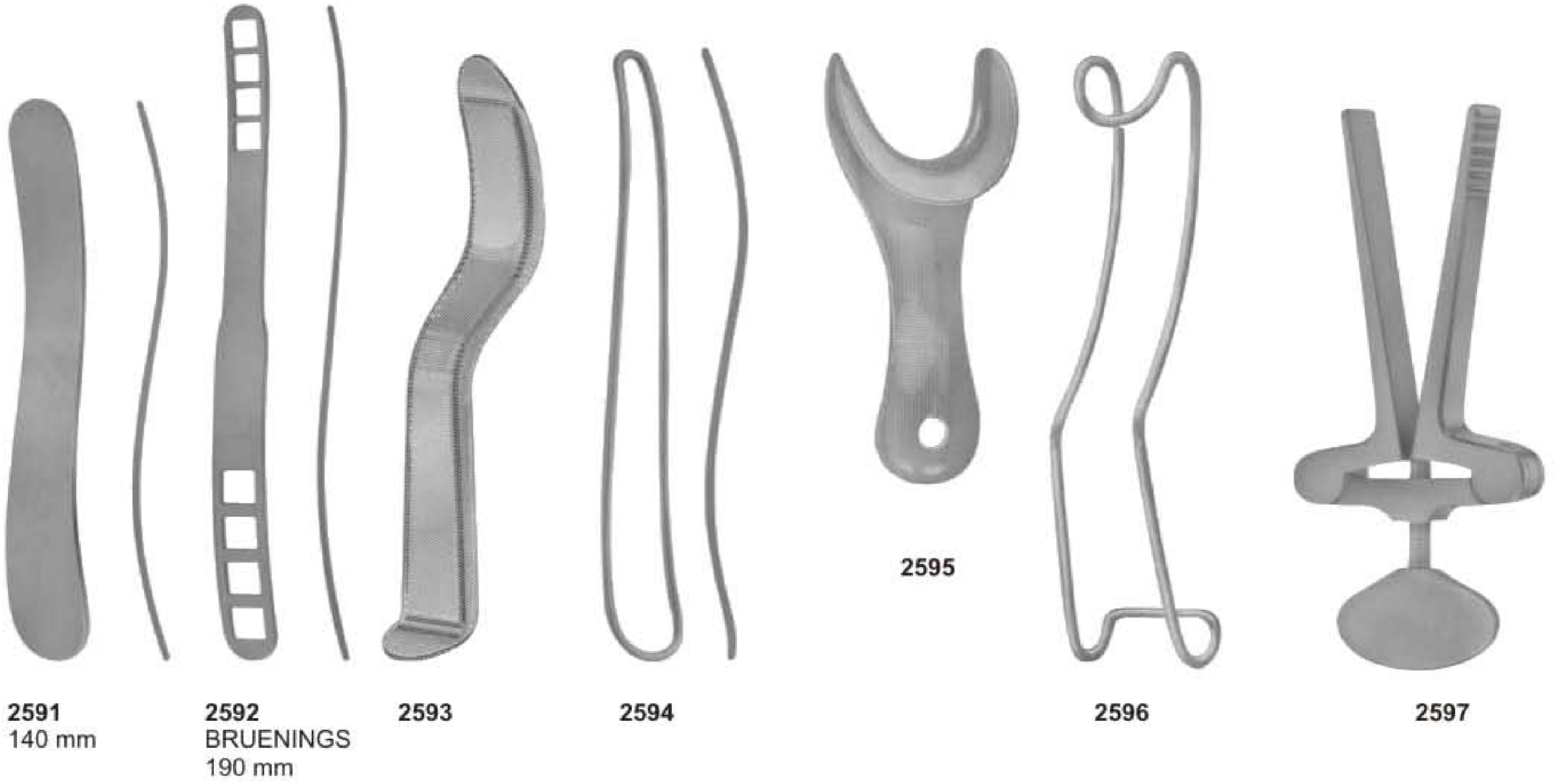

**2591**  
140 mm

**2592**  
BRUENINGS  
190 mm

**2593**

**2594**

**2595**

**2596**

**2597**

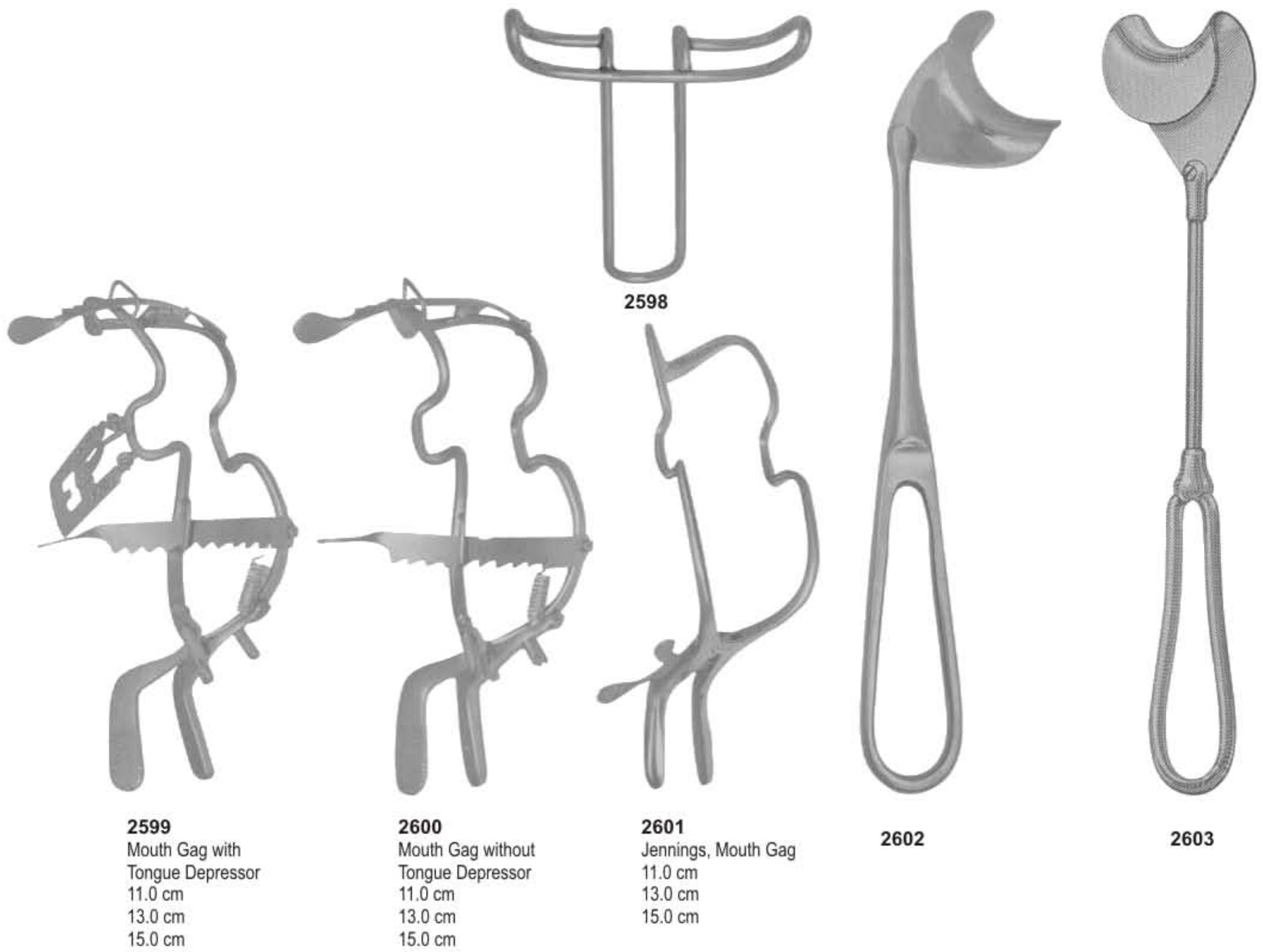

**2598**

**2599**  
Mouth Gag with  
Tongue Depressor  
11.0 cm  
13.0 cm  
15.0 cm

**2600**  
Mouth Gag without  
Tongue Depressor  
11.0 cm  
13.0 cm  
15.0 cm

**2601**  
Jennings, Mouth Gag  
11.0 cm  
13.0 cm  
15.0 cm

**2602**

**2603**

- 30 x 4 mm A
- 23 x 7 mm B
- 24 x 11 mm C
- 29 x 10 mm D
- 30 x 11 mm E
- 32 x 14 mm F
- 40 x 11 mm G
- 42 x 10 mm H
- 50 x 11 mm I
- 55 x 11 mm J
- 60 x 11 mm K
- 70 x 11 mm L
- 70 x 14 mm M

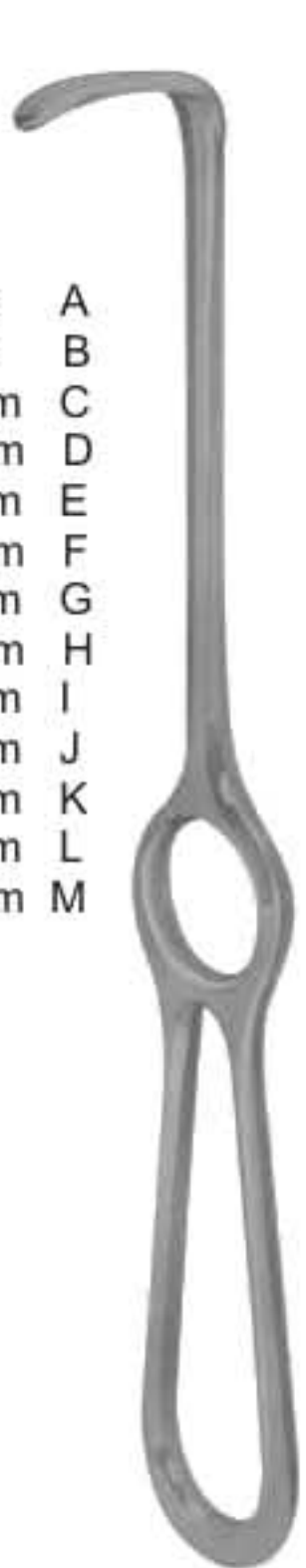

**2604**  
LANGENBECK  
210 mm



**2605**  
KOCHER-LANGENBECK  
215 mm



**2606**  
BUCHS  
205 mm



38 x 18 mm



**2607**  
KOCHER  
230 mm



**2608**  
MIDDELDORPF



**2609**  
15 x 15 mm  
220 mm



**2610**  
20 x 22 mm  
215 mm



**2611**  
28 x 28 mm  
235 mm



**2612**  
KOCHER  
230 mm



**2613**  
COLLIN  
150 mm



**2614**  
ROUX  
Set  
165 mm



**2615**  
Sterilizing Forcep Curved  
20 cm A  
25 cm B  
30 cm C



**2616**  
Sterilizing Forcep Straight  
20 cm A  
25 cm B  
30 cm C



**2617**  
Sterilizing Forcep  
30 cm



**2618**  
Becht Tweezer



**2619**  
Sterilizing Forcep  
23 cm A  
30 cm B



**2620**  
Sterilizing Forcep  
20 cm

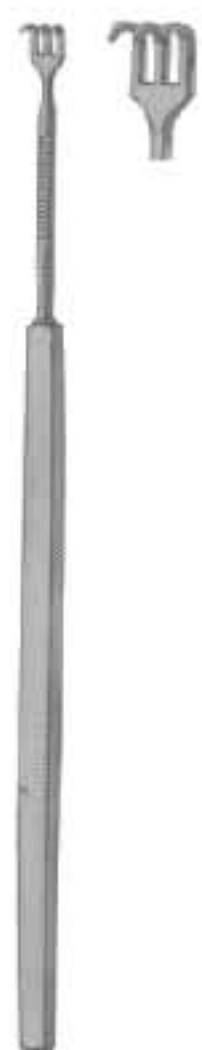

**2621**  
3 sharp prongs



**2622**  
2 sharp prongs  
6"



**2623**  
2 sharp prongs  
6"



**2624**  
FOMON  
145 mm



**2625**  
ALM  
70 mm



**2626**  
SENN  
3 sharp prongs  
6 3/8"



**2627**  
TOENNIS  
Dura Retractor  
150mm







**2628**  
JOSEPH  
165 mm

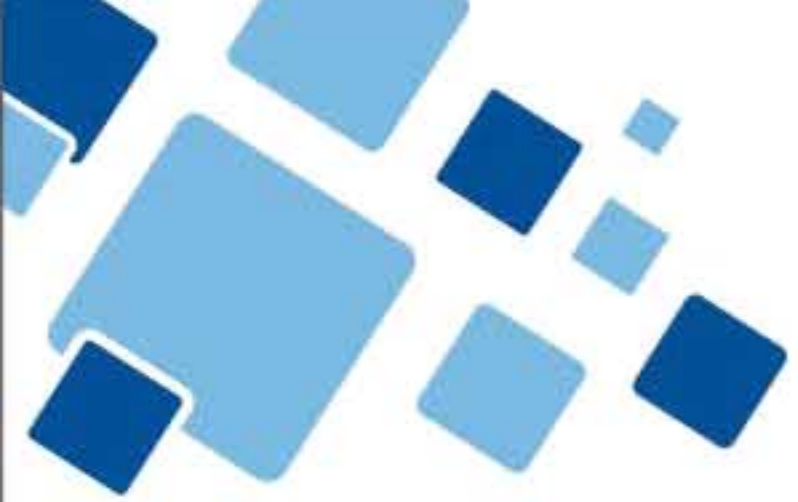

**2629**  
GILLIES  
180 mm



-  Orthodontic Pliers
-  Orthodontic Cutters
-  Rongeurs
-  Needle Holders



# 07

SECTION





**2630**  
Light Wire Cutter



**2631**  
Wire Cutter



**2632**  
Posterior Band Remover  
Long



**2633**  
Posterior Band Remover  
Short



**2634**  
Jarabak Plier



**2635**  
Distal End Cutter  
Safety End Cutter



**2636**  
Distal End Cutter



**2637**  
Kim's Plier



**2638**  
Loop Forming Plier



**2639**  
Tweed Arch Bending Plier



**2640**  
Utility Plier



**2641**  
Bonding Bracket Remover



**2642**  
Lingual Arch Plier



**2643**  
Light Wire Plier



**2644**  
Wire Cutter  
12.5 cm



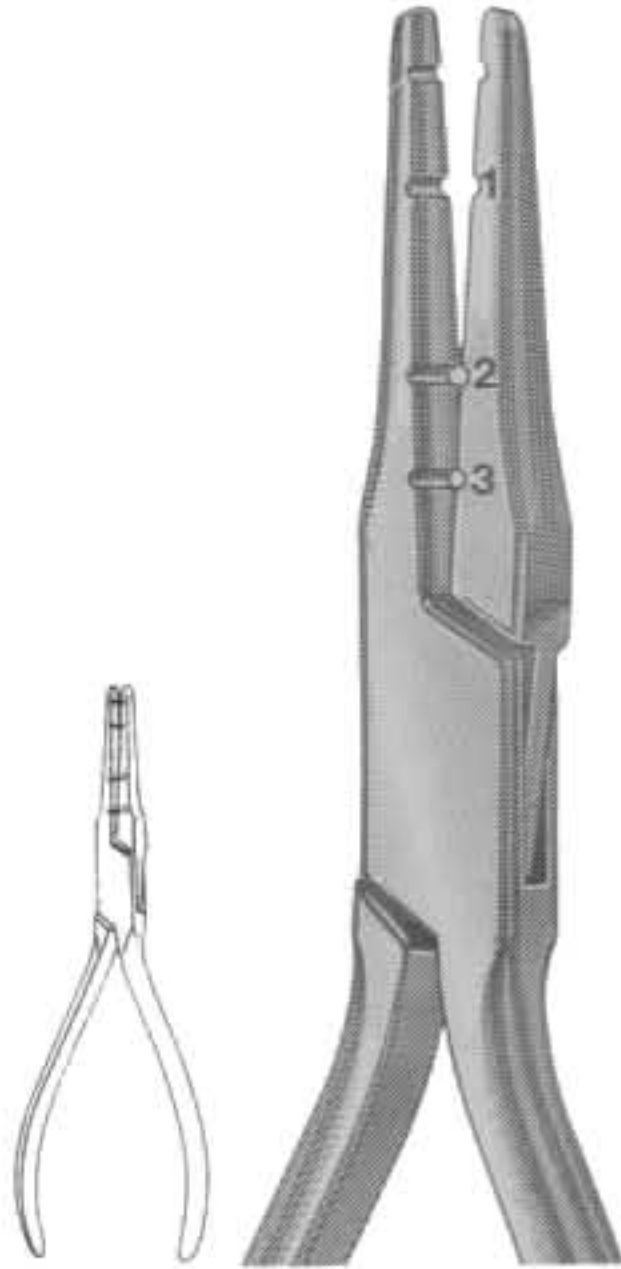

**2645**  
Fig. 101  
Wire Bending

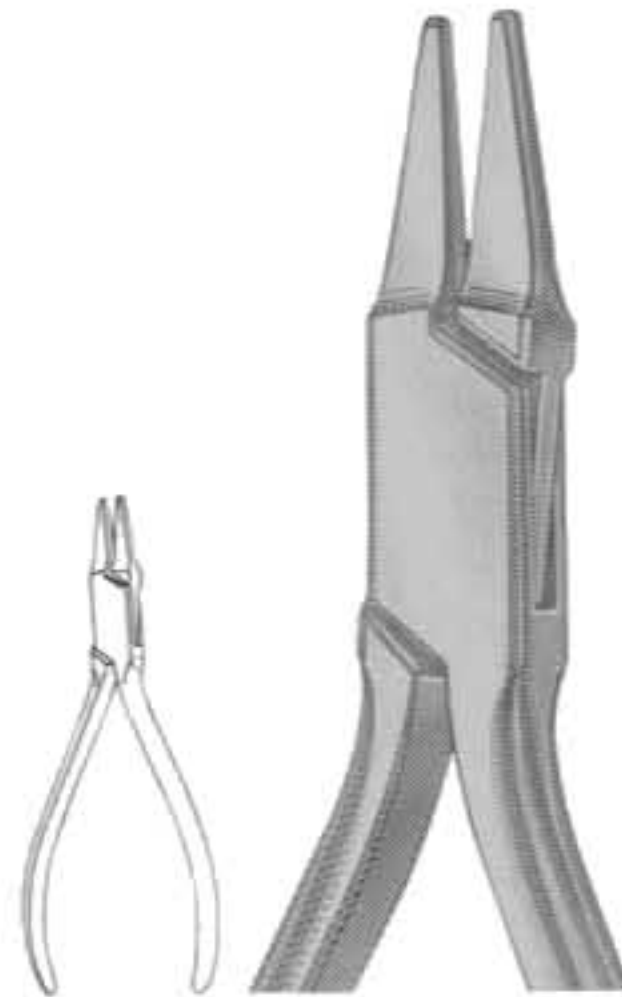

**2646**  
Fig. 118  
PEESO  
Collar

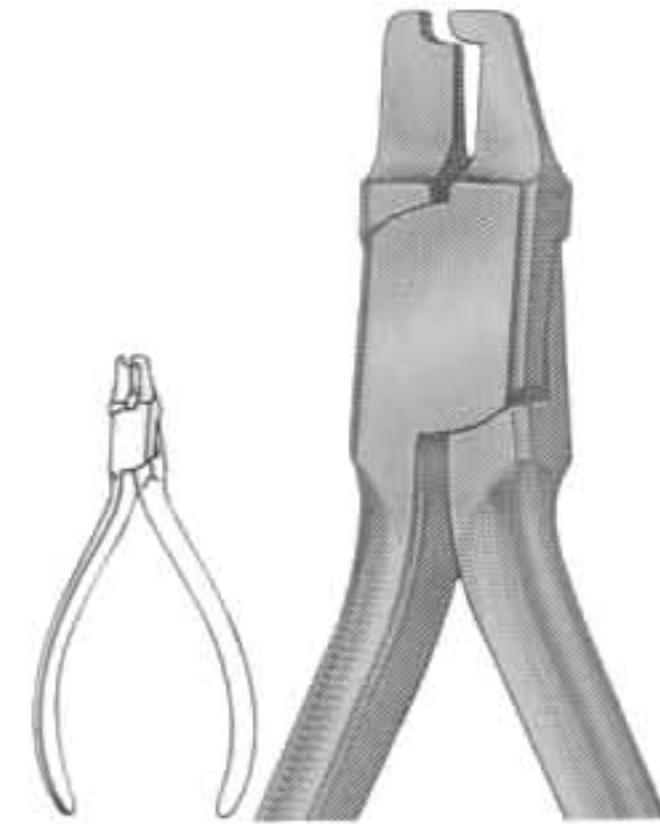

**2647**  
Fig. 417  
Crown Shell

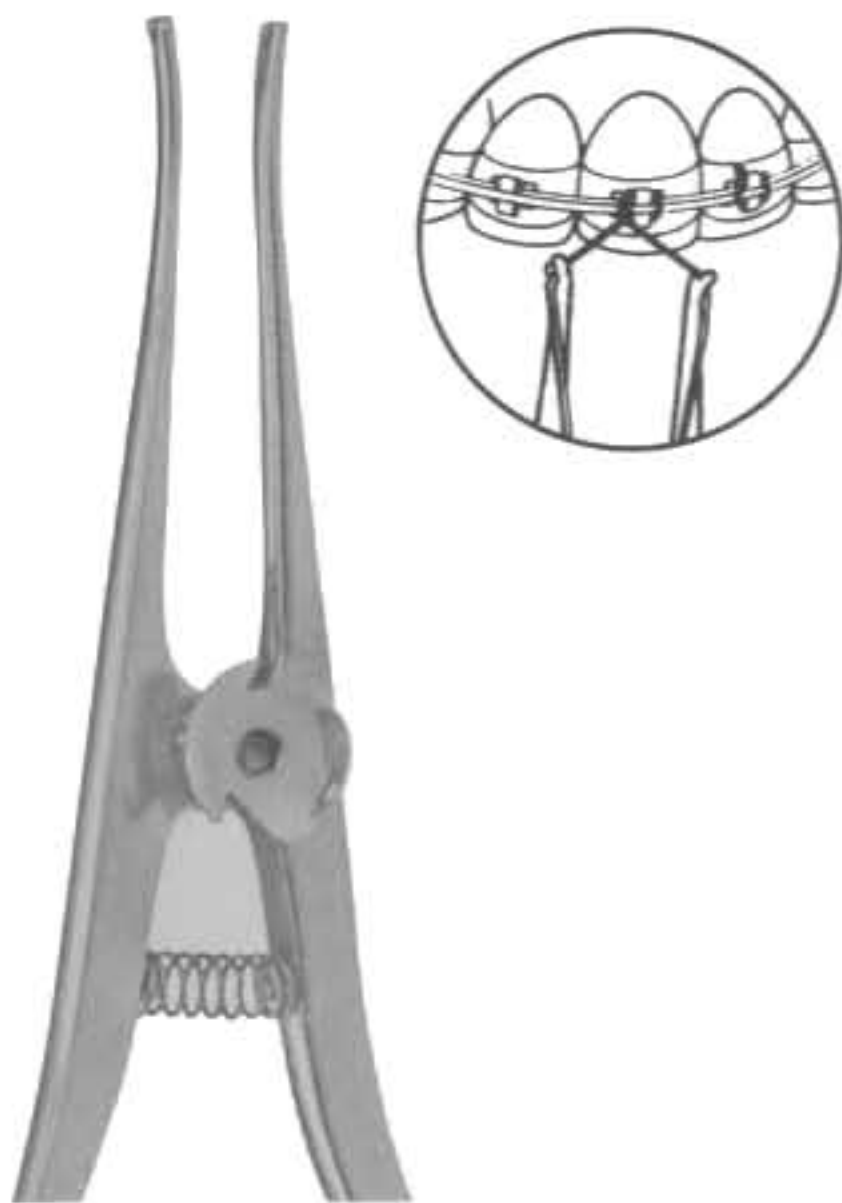

**2648**  
STEINER  
150 mm  
Ligature Pliers

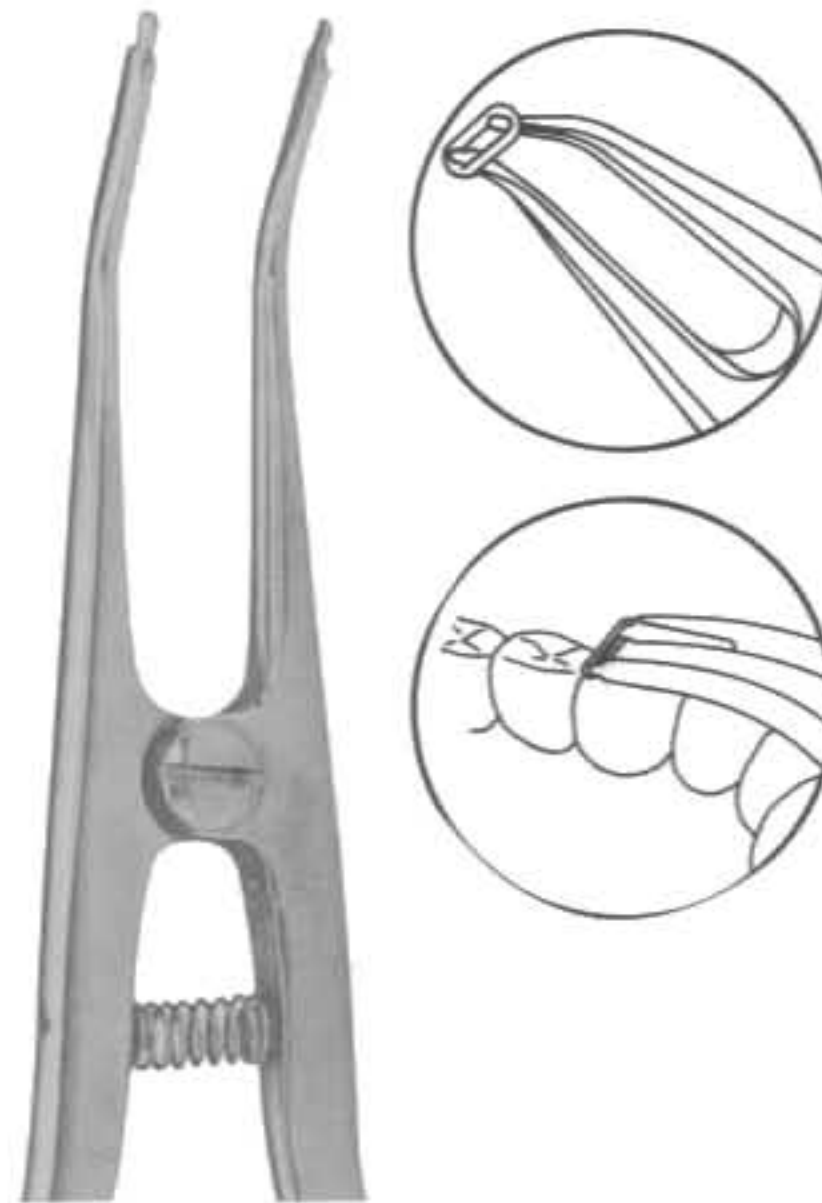

**2649**  
Separating Pliers Elastics  
150 mm

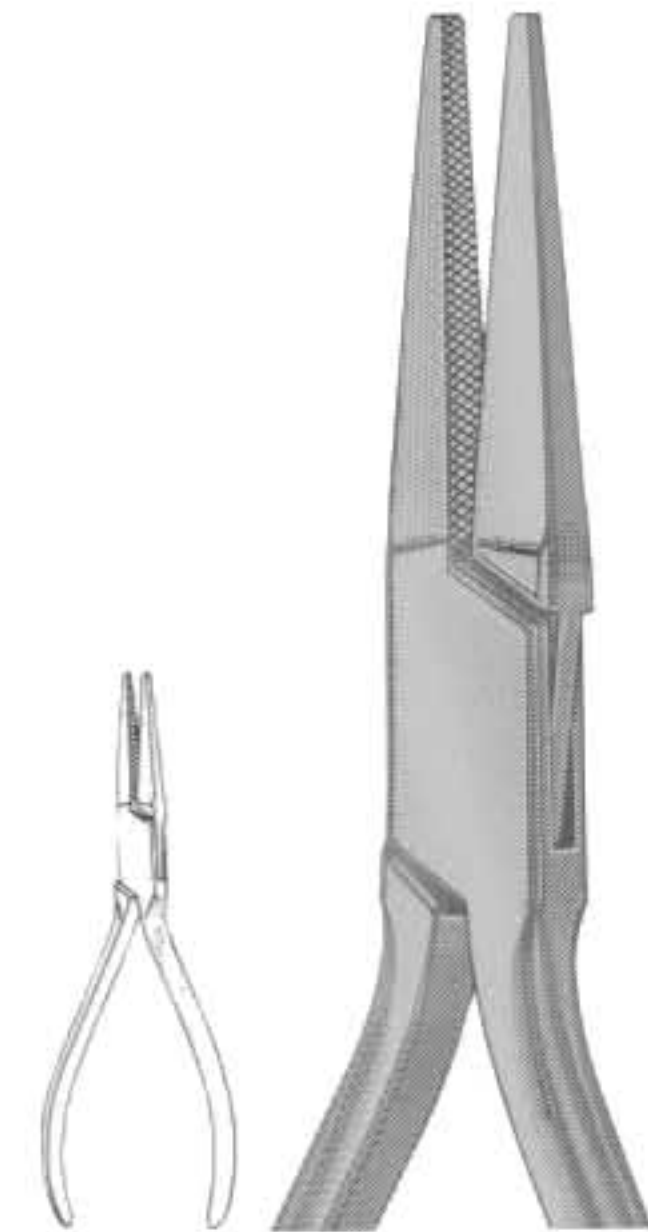

**2650**  
121-Lab & Office



**2651**  
How Plier-Titanium Alloy  
With special coated beaks

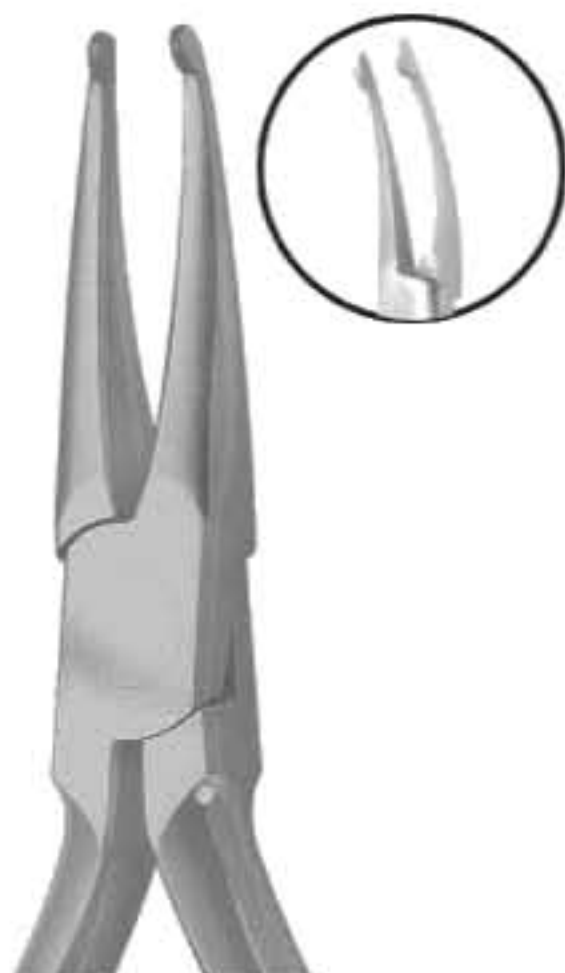

**2652**  
How Plier  
Tips are 1/8"(3.2mm)  
diameter

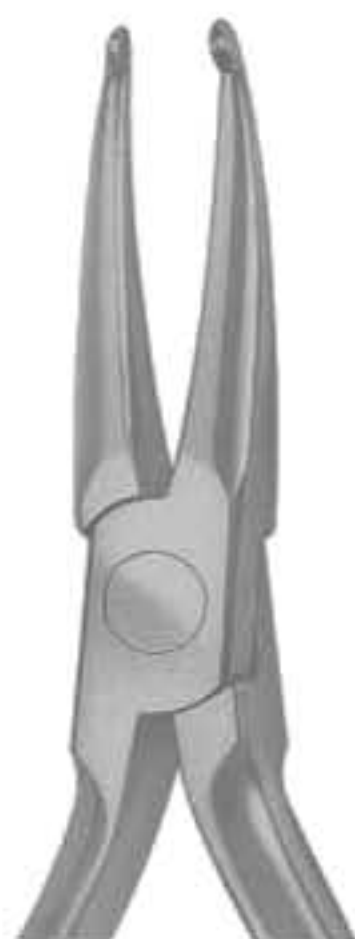

**2653**  
How Plier  
Tips are 1/8"(3.2mm)  
diameter



**2654**  
How Plier-Small  
Tips are 3/32"(2.4mm)  
diameter



**2655**  
How Plier-Offset  
Tips are 1/8"(3.2mm)  
diameter



**2656**  
Weingart Utility Plier  
-Titanium Alloy  
with special coated beaks

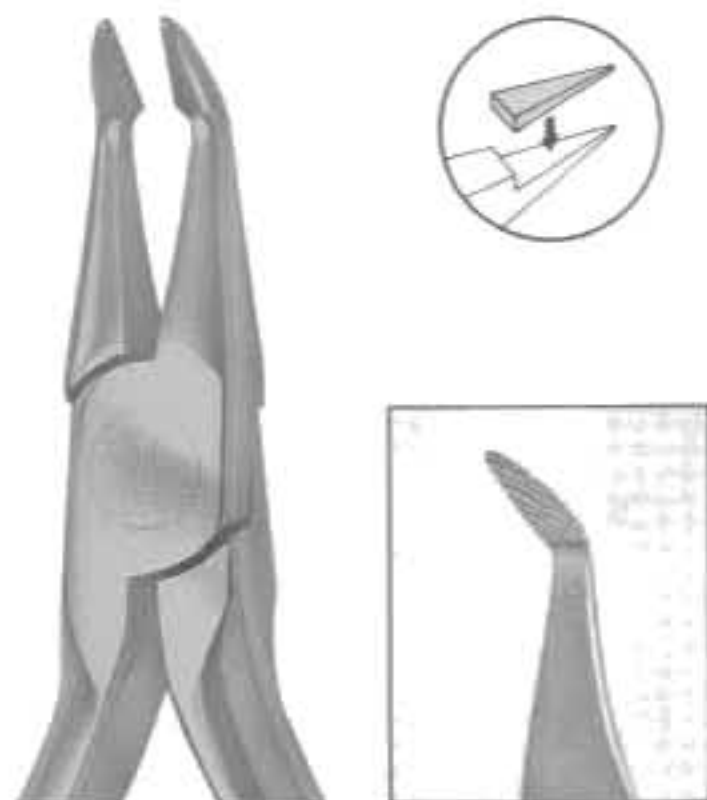

**2657**  
Weingart Utility Plier  
New type of the Weingart Utility Plier  
designed for a more precise operation.

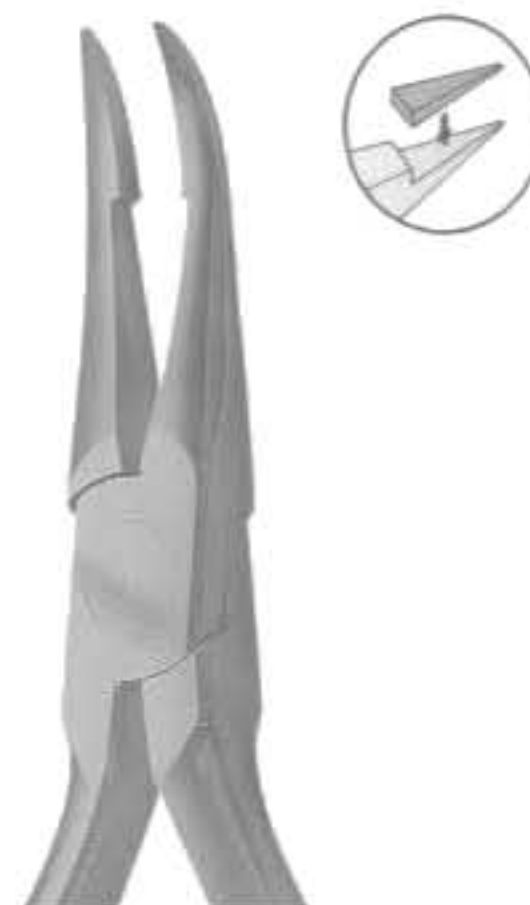

**2658**  
Weingart Utility Plier



**2659**  
Weingart Utility Plier

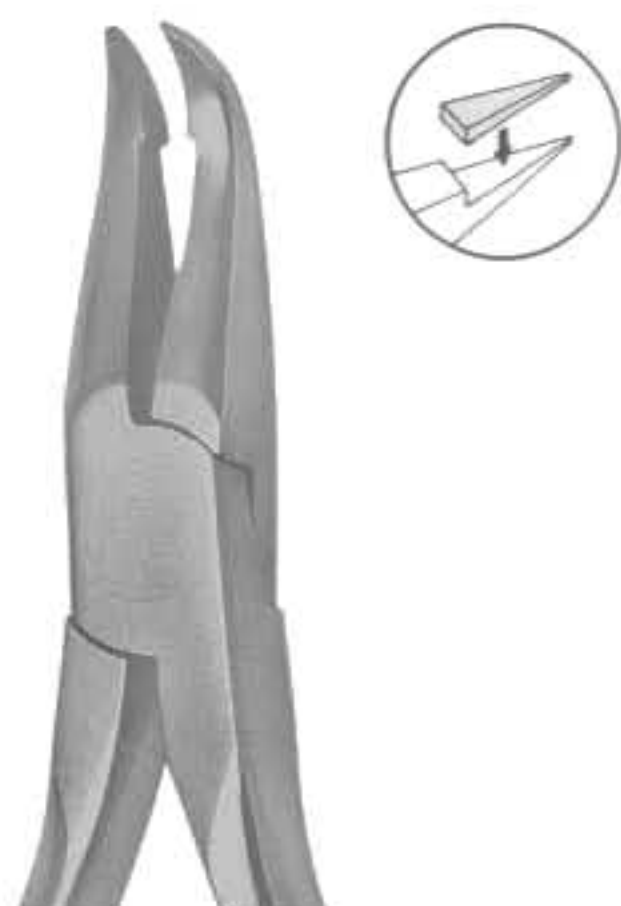

**2660**  
Weingart Utility Plier

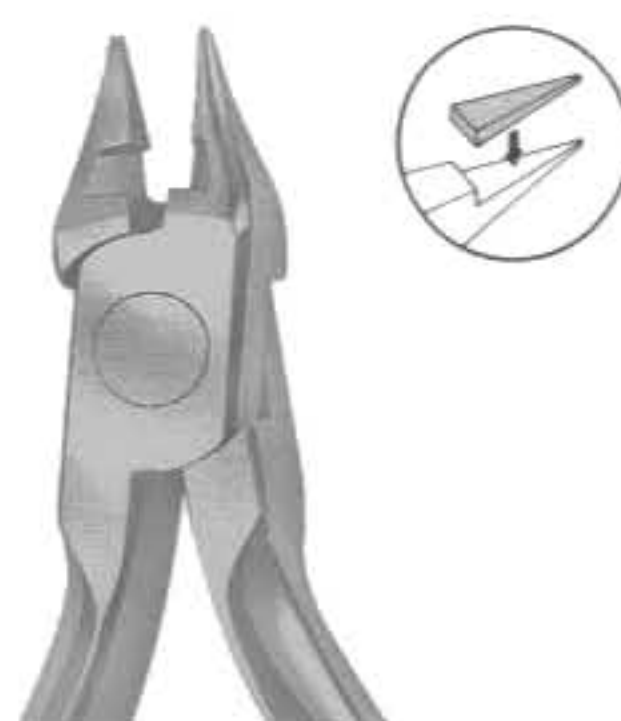

**2661**  
Bird Beak Plier With Cutter  
**Maximum Bending & Cutting Capacity:**  
Wires up to .032"

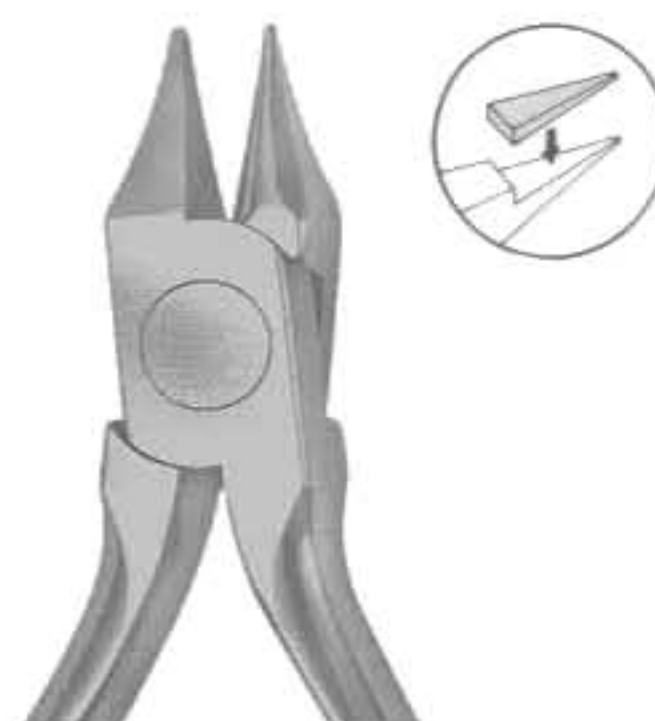

**2662**  
Bird Beak Plier  
**Maximum Bending Capacity:**  
Wires up to .032"



**2663**  
Bird Beak Plier  
**Maximum Bending Capacity:**  
Wires up to .030"



**2664**  
TWEED (Fig. 98)  
13 cm, 5 1/8"  
Tweed Loop Omega Pliers.



**2665**  
TWEED - (Fig. 90)  
14 cm, 5 1/2"



**2666**  
O'BRIEN - (Fig. 97)  
14 cm, 5 1/2"

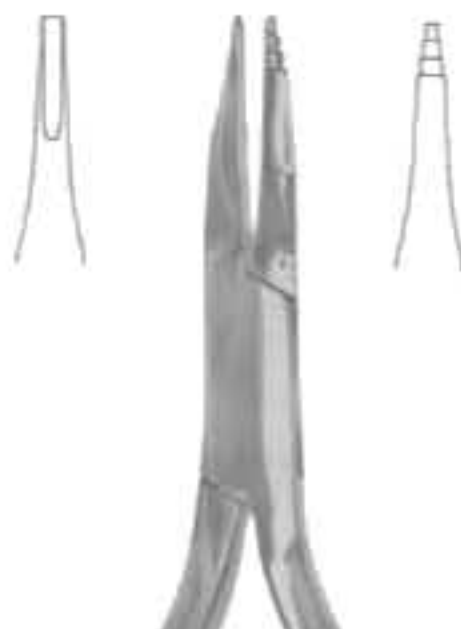

**2667**  
TWEED (Fig. 96)  
14 cm, 5 1/2"



**2668**  
TWEED (Fig. 95)  
13.5 cm, 5 1/4"

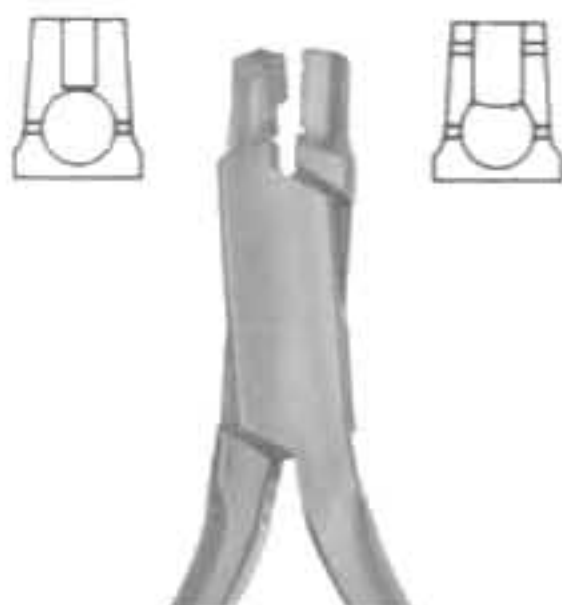

**2669**  
SCHWARZ (Fig. 29)  
12.5 cm, 5"



**2670**  
NANCE (Fig. 80)  
13 cm, 5 1/8"

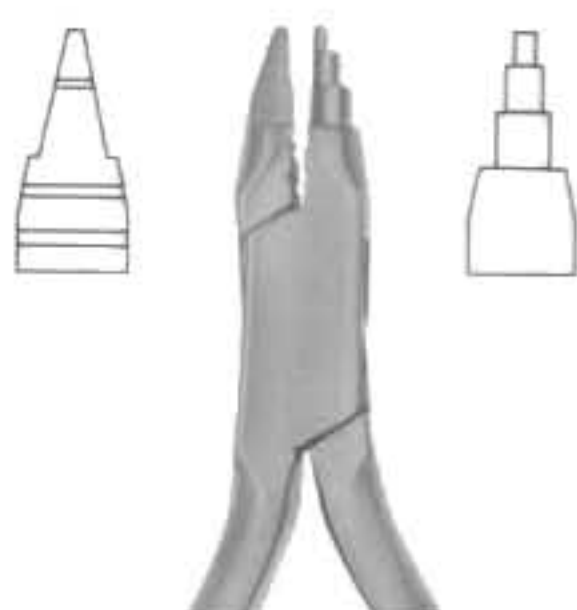

**2671**  
YOUNG (Fig. 55)  
13 cm, 5 1/8"



**2672**  
SCHWARZ (Fig. 30)  
13 cm, 5 1/8"

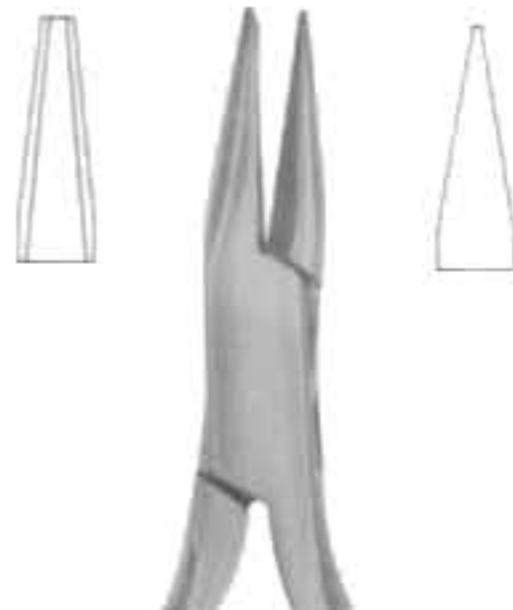

**2673**  
Optical Plier (Fig. 53)  
14 cm, 5 1/2"

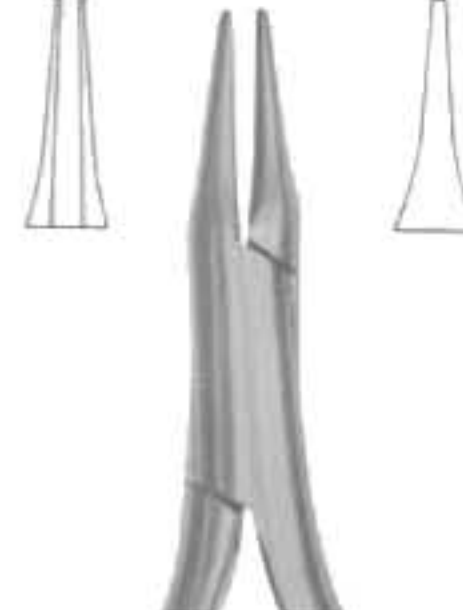

**2674**  
Schwarz (Fig. 79)  
13.5 cm, 5 1/4"

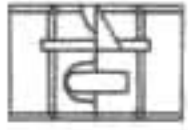

**2675**  
NANCE (Fig. 56)  
12.5 cm, 5"  
Wire bending Pliers



**2680**  
14.0 cm  
Goslee Contouring Plier



**2676**  
JOHNSON (Fig. 59)  
13.5 cm, 5 1/4"  
Contouring Plier.



**2677**  
REYNOLDS (Fig. 61)  
13 cm, 5 1/8"  
Contouring Plier.



**2678**  
De La Rosa (Fig. 34)  
12.5 cm, 5"  
Contouring Plier, Non-Grooved



**2679**  
De La Rosa (Fig. 35)  
12.5 cm, 5"  
Contouring Plier, Grooved



**2681**  
14.0 cm  
Goslee Contouring Plier

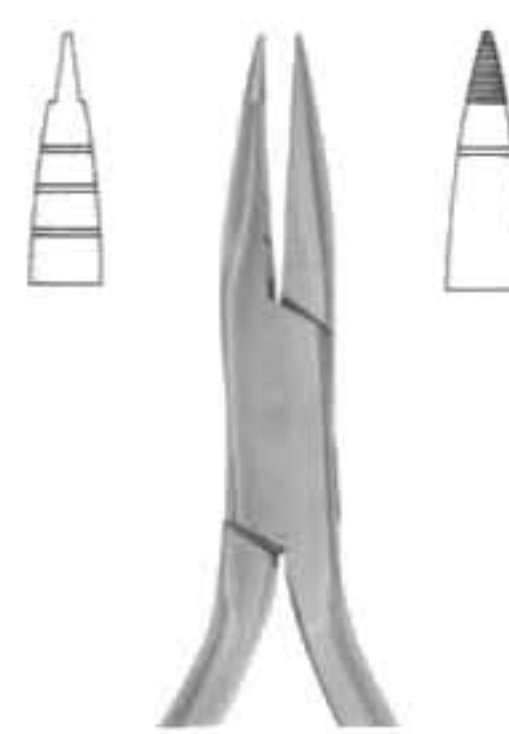

**2682**



**2683**  
Fig. 58  
12.5 cm, 5"  
Lingual Arch Bending Plier

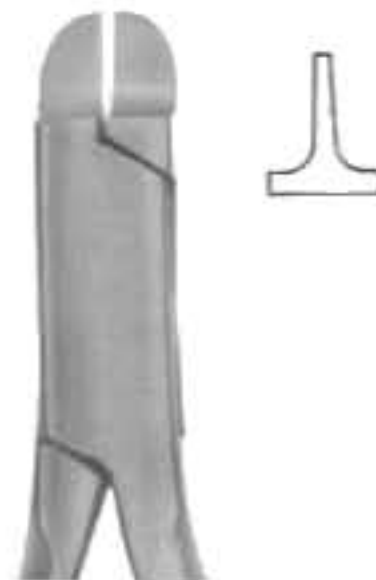

**2684**  
Frevert/Tweed (Fig. 51)  
12.5 cm, 5"  
Tweed Arch Plier/Standard Jaw

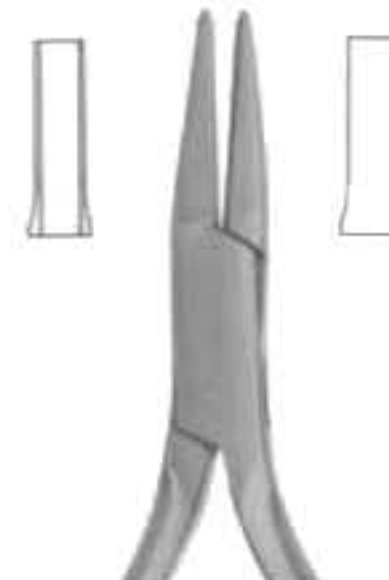

**2685**



**2686**  
ANGLE (Fig. 52)  
13 cm, 5 1/8"  
Arch Forming Plier



**2687**  
Fig. 60  
13 cm, 5 1/8"  
Wire & Clasp Bending Pliers



**2688**  
Fig. 60  
13 cm, 5 1/8"  
Wire & Clasp Bending Pliers

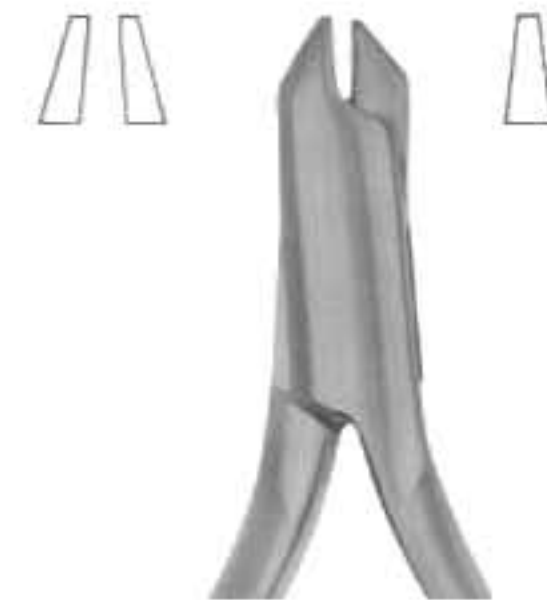

**2689**  
Aderer (Fig. 57)  
12 cm, 4 3/4"  
Wire & Clasp Bending Pliers



**2690**  
49 e 49 TC  
14 cm, 5 1/2"  
Band Removing Plier, short pad



**2691**  
50 e 50 TC  
14 cm, 5 1/2"  
Band Removing Plier, long pad



**2692**  
Fig. 84  
14.5 cm, 5 3/4"  
Band pinshing & ligature  
locking plier, serrated



**2693**  
Fig. 72  
14 cm, 5 1/2"  
Band pinshing & ligature  
locking plier, serrated



**2694**  
BRACKET (Fig. 82)  
13.5 cm, 5 1/4"  
Direct Bonding Bracket Remover



**2695**  
BRACKET (Fig. 83)  
13.5 cm, 5 1/4"  
Direct Bonding  
Bracket Remover



**2696**  
38c, 38TC  
13.5 cm, 5 1/4"  
Contouring closing loop pliers,  
wire bending, cutter.

**2697**  
40c, 40TC  
13.5 cm, 5 1/4"  
Contouring pliers light wire pliers  
grooved with cutter.

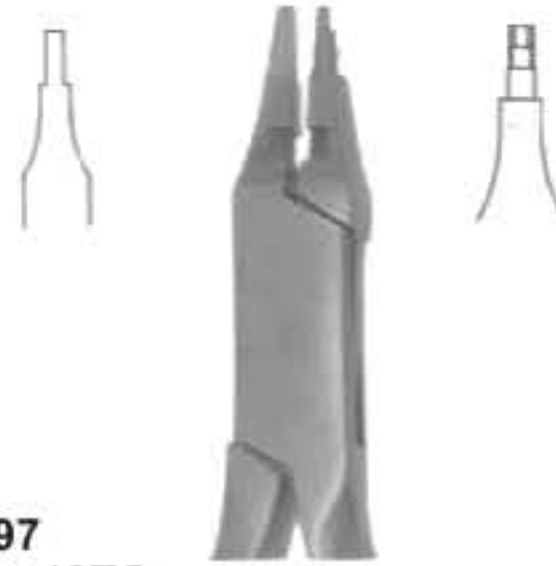

**2698**  
Fig. 81  
12.5 cm, 5"  
Sling clasp & wire bending plier

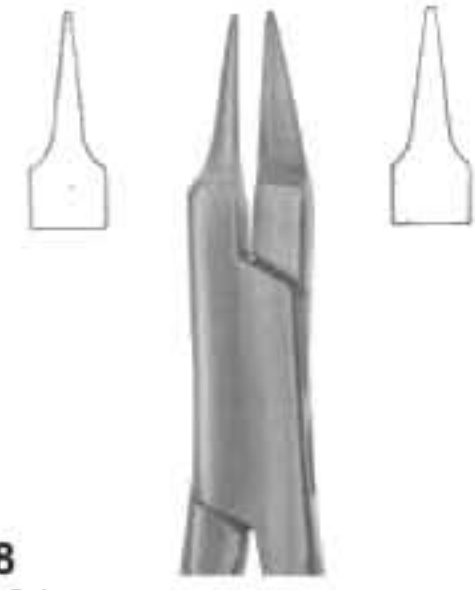

**2699**  
Fig. 28  
14 cm, 5 1/2"  
Sling clasp & wire bending plier.



**2700**  
Fig. 21  
13 cm, 5 1/8"  
Light wires pliers, grooved

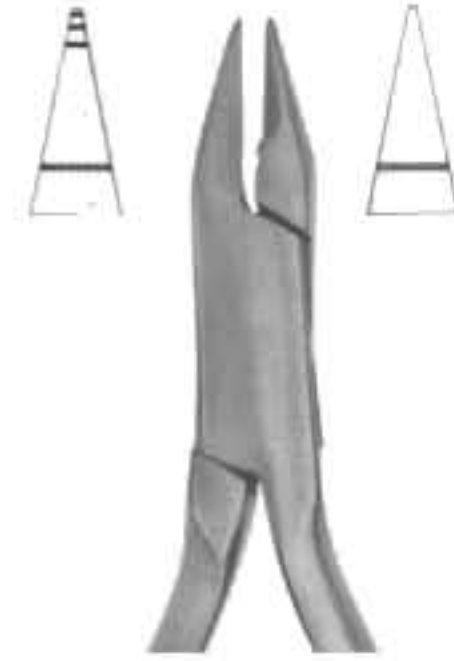

**2704**  
46c - 46 TC  
ADAMS - N. 139c  
12.5 cm, 5"  
Bird beak with cutter.

**2701**  
ADAMS, 23, 23TC  
12.5 cm, 5"  
Sling clasp & wire bending plier.

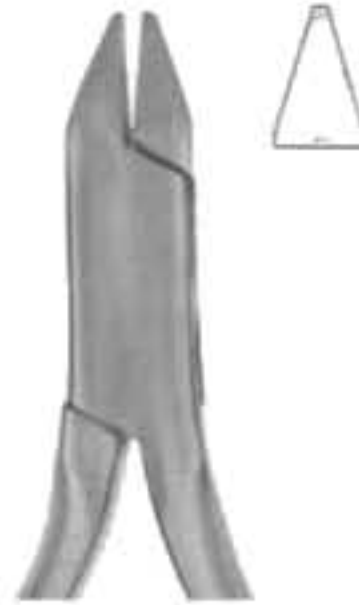

**2702**  
ADAMS (Fig. 33)  
12.5 cm, 5"  
For retaining elements.



**2703**  
ADAMS (Fig. 44)  
12.5 cm, 5"  
Sling clasp & wire bending plier.



**2705**  
Universal Wire Bending  
Pliers (ADAMS) 47 TC, N.64  
12.5 cm, 5"  
Sling clasp & wire bending plier.



**2706**  
86c, 86 TC  
Angle Bird Beak - N.138  
12.5 cm, 5"  
Sling clasp & wire bending plier.





Ø 1.0 mm  
(0.40")

**2707**  
Fig. 18 TC  
15 cm, 6"



Ø 1.0 mm  
(0.40")

**2708**  
Fig. 92 TC  
14 cm, 5 1/2"



Ø 0.4 mm  
(0.16")

**2709**  
Fig. 91 TC  
13 cm, 5 1/8"



Ø 0.4 mm  
(0.16")

**2710**  
Fig. 99 TC  
13 cm, 5 1/8"



Ø 0.4 mm  
(0.16")

**2711**  
Fig. 94 TC  
13 cm, 5 1/8"  
Angled at 15° with or  
without spring on \  
the handles.



**2712**  
Fig. 85 TC  
13 cm, 5 1/8"



**2713**  
Fig. 87 TC  
13 cm, 5 1/8"



**2714**  
Fig. 85 TC  
Angled at 15°  
13 cm, 5 1/8"



**2715**  
ADAMS 87 TC  
Angled at 15°  
13 cm, 5 1/8"

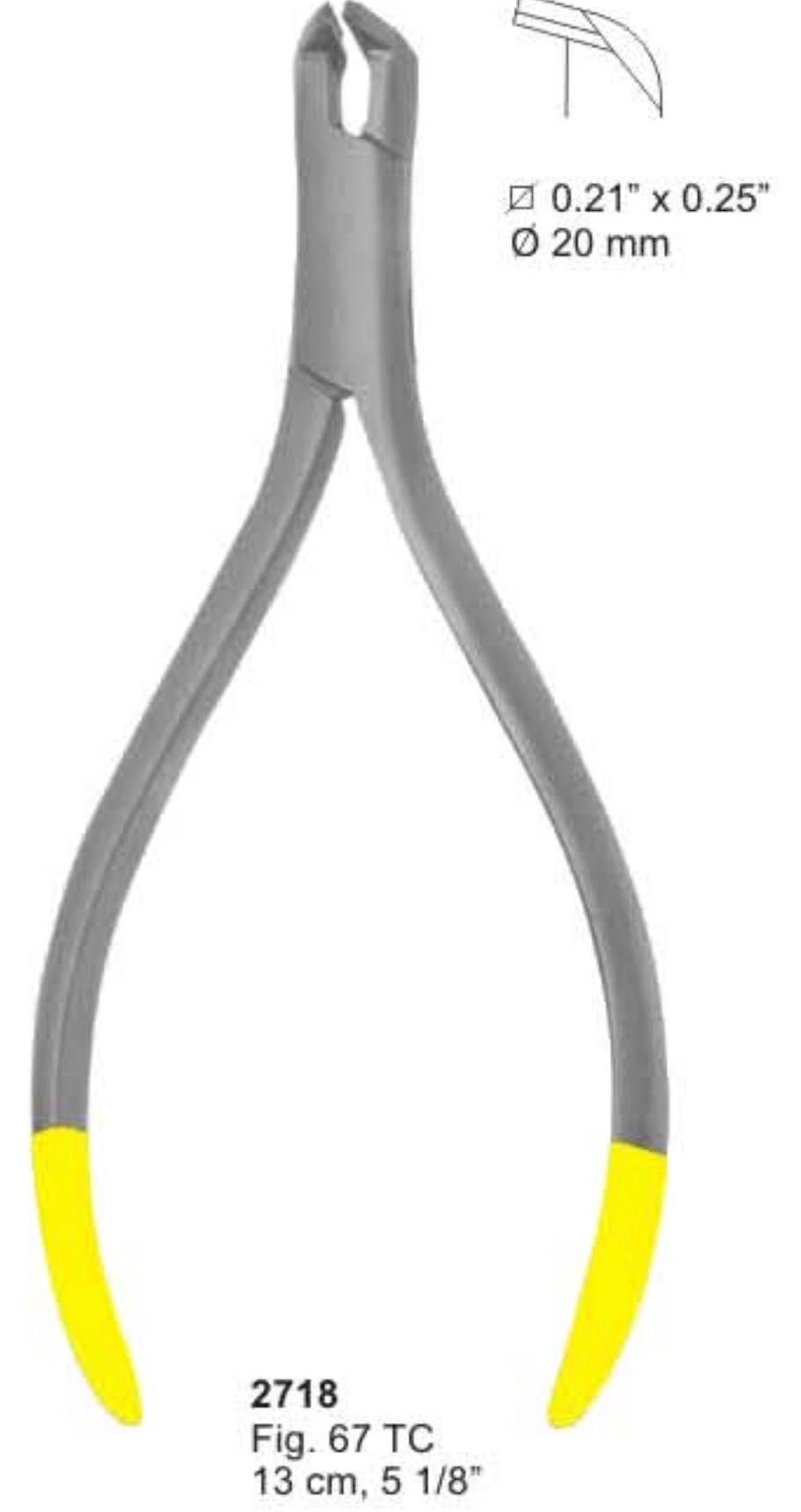





**2721**  
UNIVERSAL  
150 mm

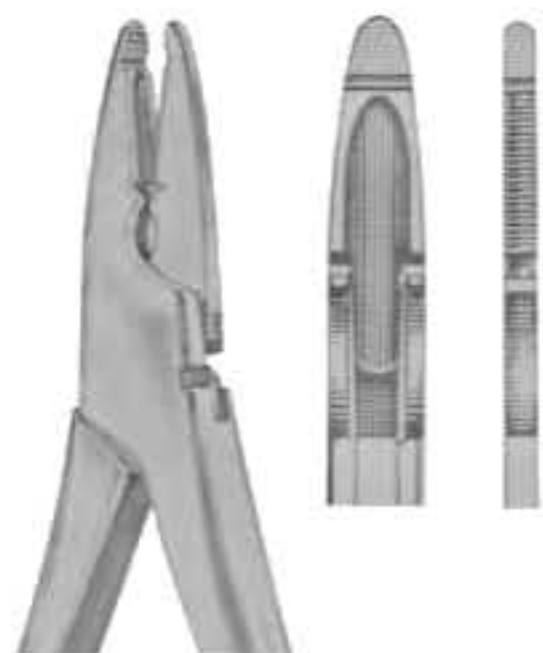

**2722**  
WALDSACHS  
155 mm



**2723**  
ADERER  
125 mm

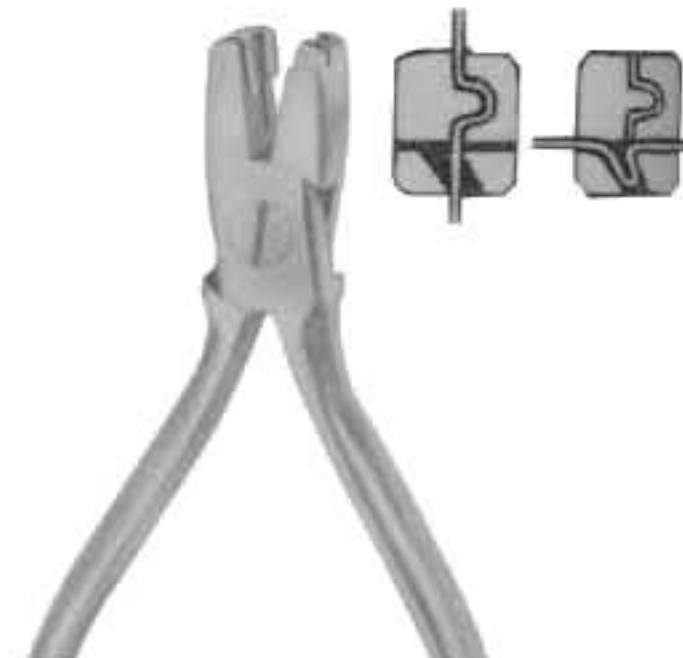

**2724**  
NANCE  
125 mm

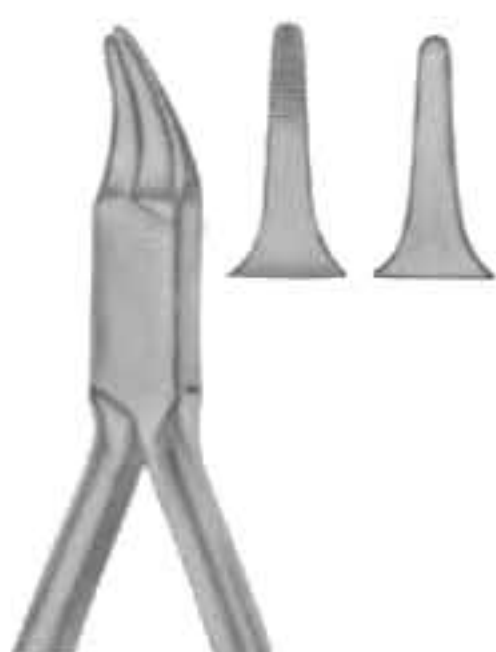

**2725**  
REYNOLDS  
125 mm



**2726**  
HOW  
145 mm



**2727**  
HOW  
140 mm



**2731**  
FURRER  
150 mm



**2728**  
WALDRON  
125 mm

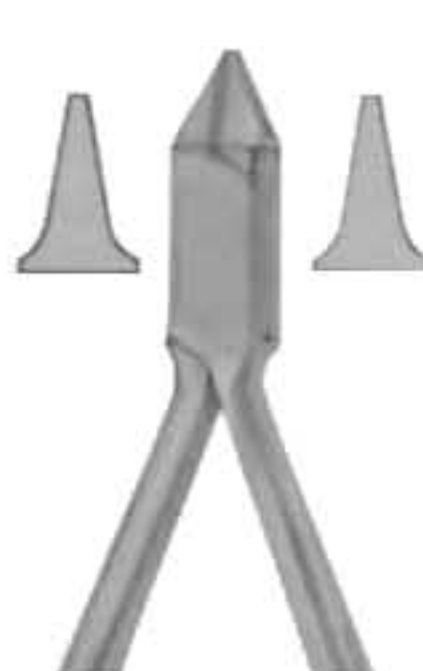

**2729**  
ADAMS  
125 mm

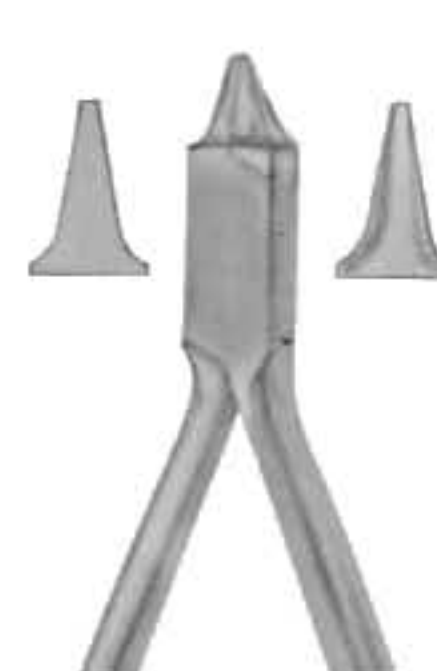

**2730**  
ANGLE  
125 mm

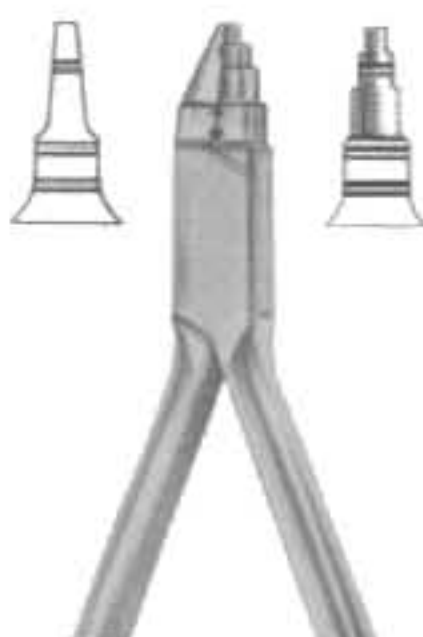

**2732**  
YOUNG  
130 mm



**2733**  
NANCE  
130 mm



**2734**  
LANGEBECK  
125 mm



**2735**  
LANGEBECK  
140 mm

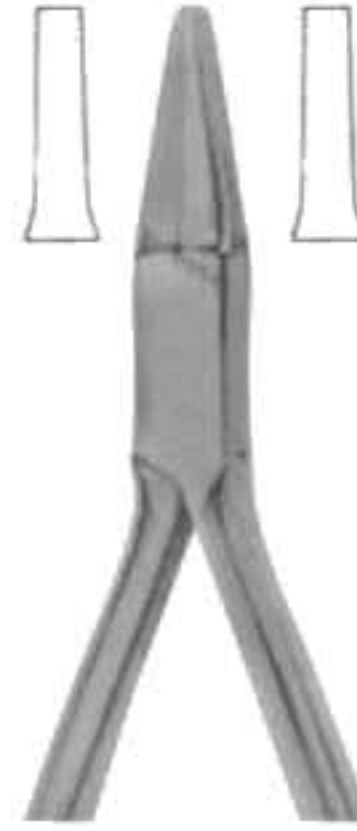

**2736**  
LANGEBECK  
130 mm

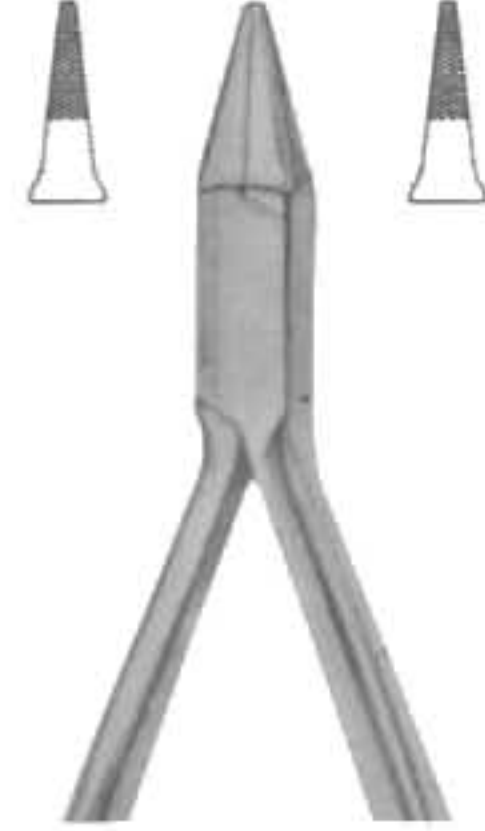

**2737**  
PEESO  
125 mm



**2738**  
GOSLEE  
125 mm

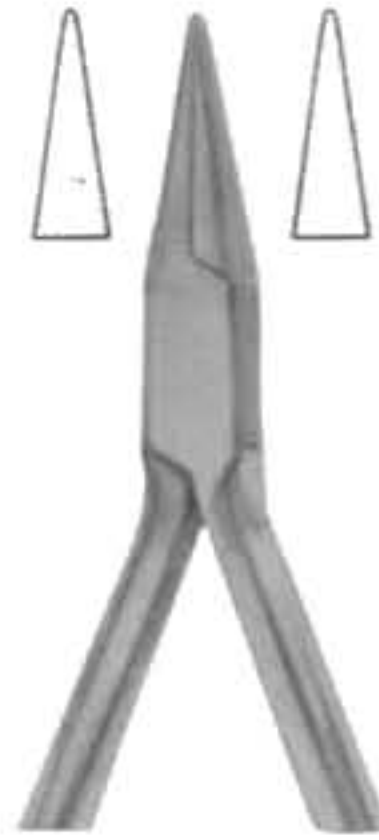

**2739**  
FISCHER  
140 mm



**2740**  
FISCHER  
140 mm



**2741**  
JOHNSON  
130 mm



**2742**  
MSY  
130 mm



**2743**  
MC KELLOPS  
155 mm



**2744**  
ANDRESEN  
130 mm

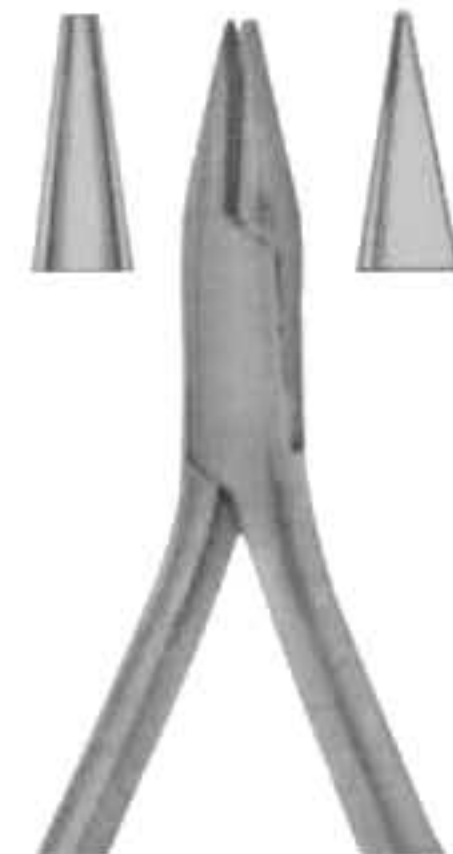

**2745**  
SCHWARZ  
130 mm



**2746**  
BLUMENTHAL  
6", 30°, Standard

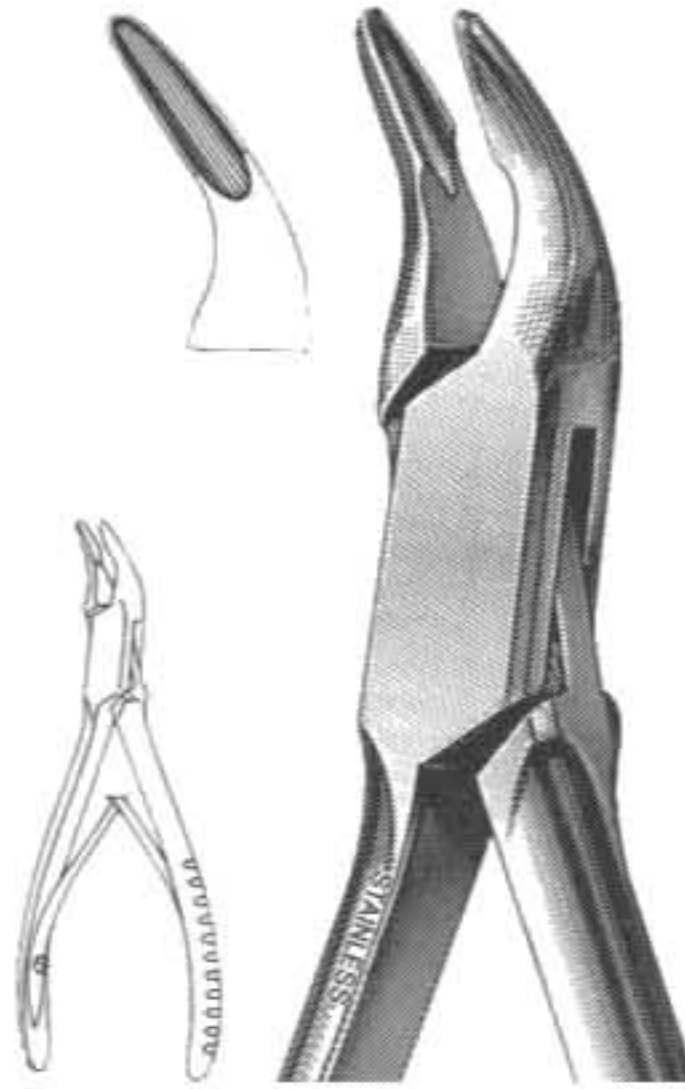

**2747**  
MINI-BLUMENTHAL  
6", 45°

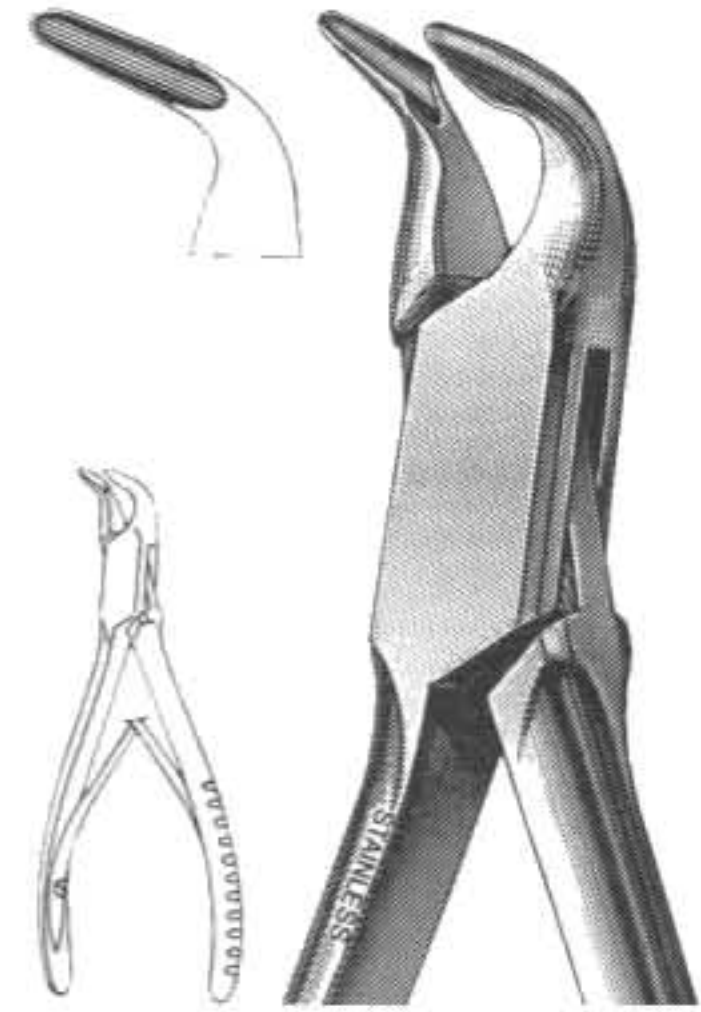

**2748**  
MINI-BLUMENTHAL  
6", 90°

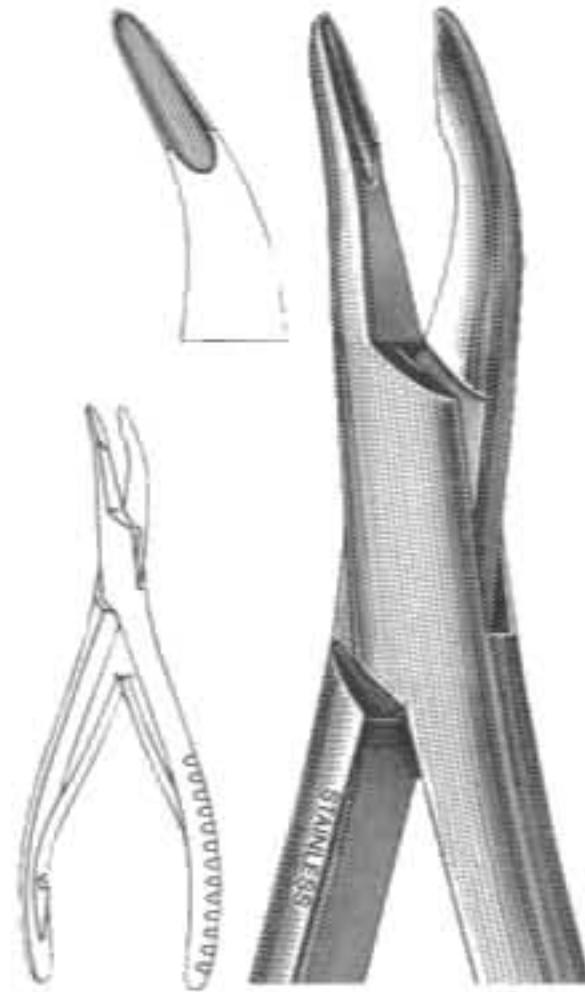

**2749**  
BLUMENTHAL  
7", 30°

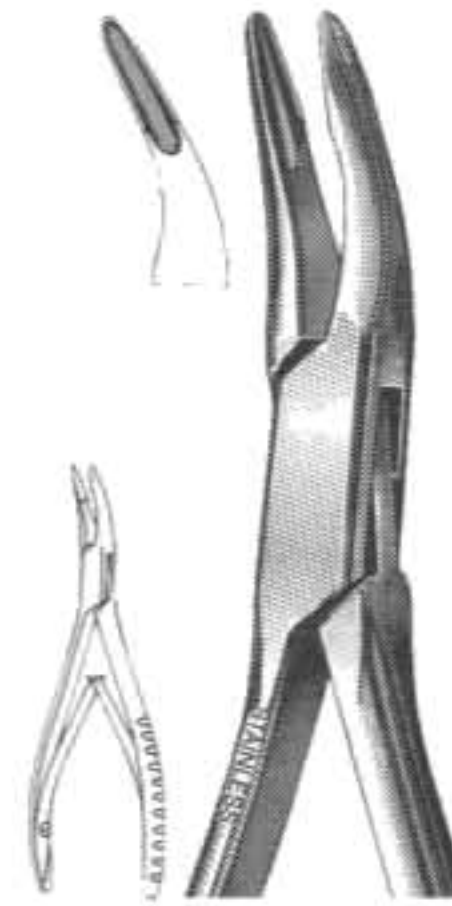

**2750**  
MINI-BLUMENTHAL  
4 1/2", 30°

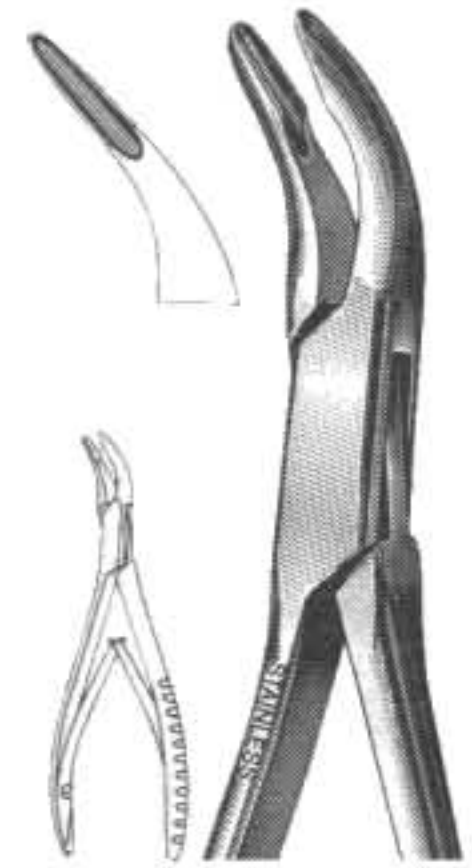

**2751**  
MINI-BLUMENTHAL  
4 1/2", 45°



**2752**  
CLEVELAND  
No. 5-Side Cutting,  
6 3/4"

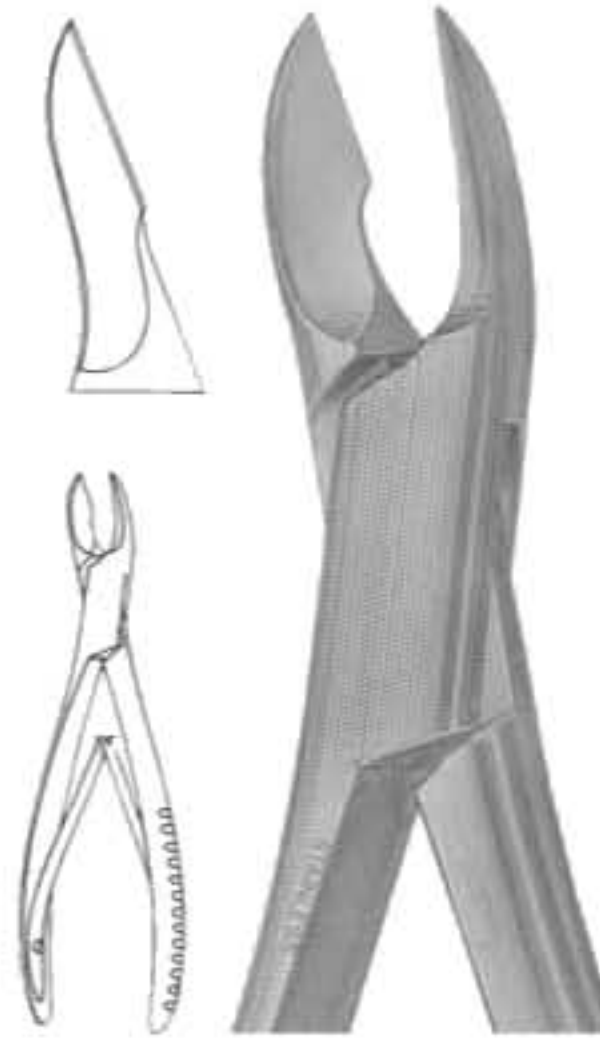

**2753**  
CLEVELAND  
No. 5A-Side Cutting,  
6 1/2"

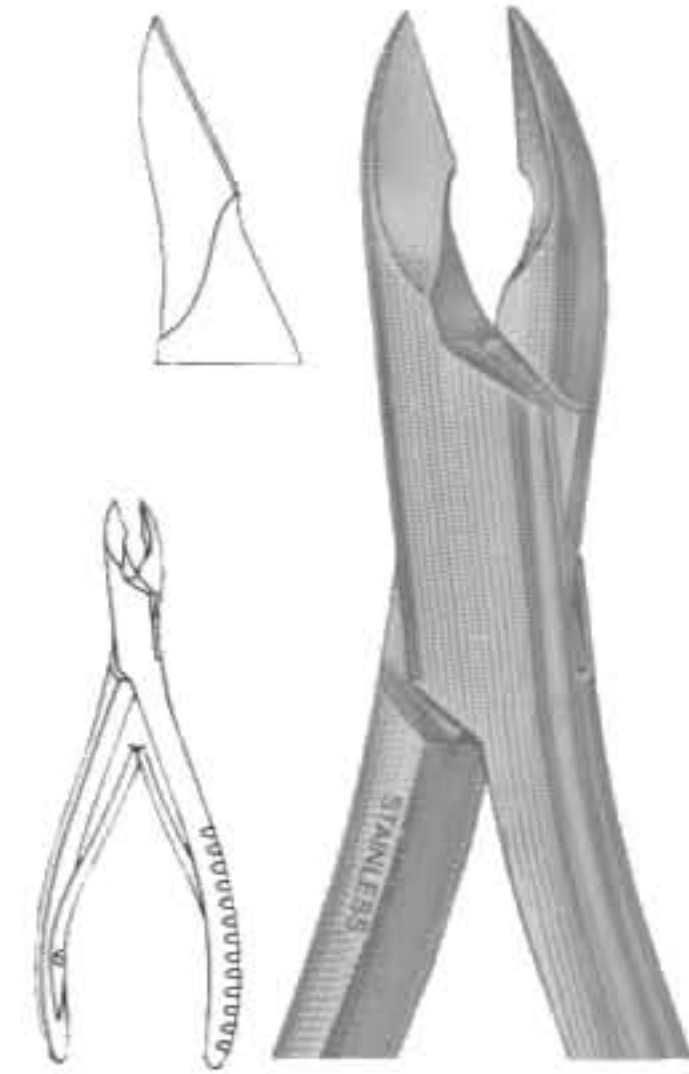

**2754**  
CLEVELAND  
No. 5S-Side Cutting,  
6"

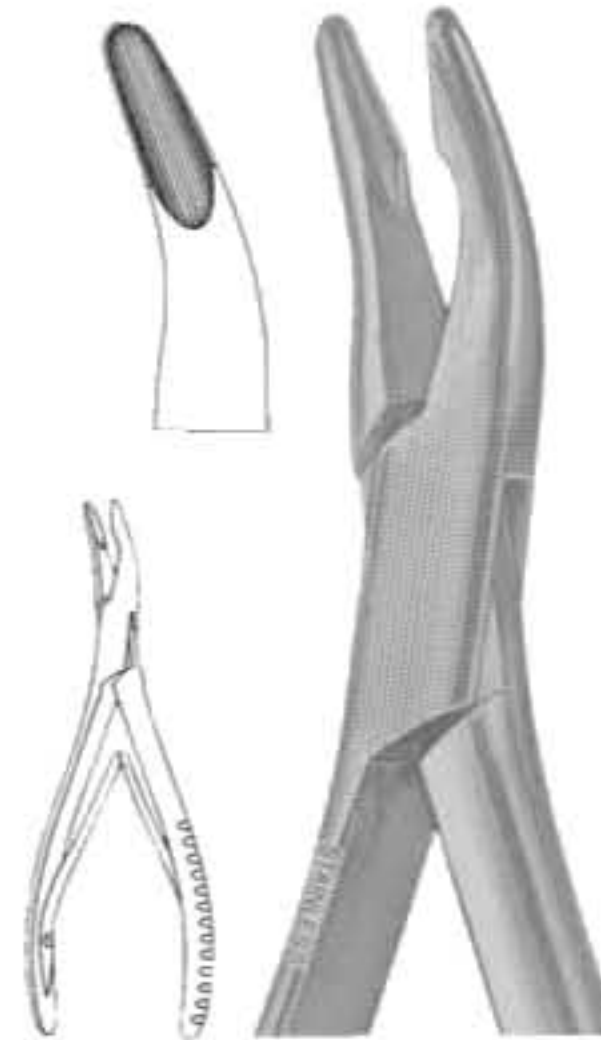

**2755**  
No. 1A-MEAD  
6 1/2"

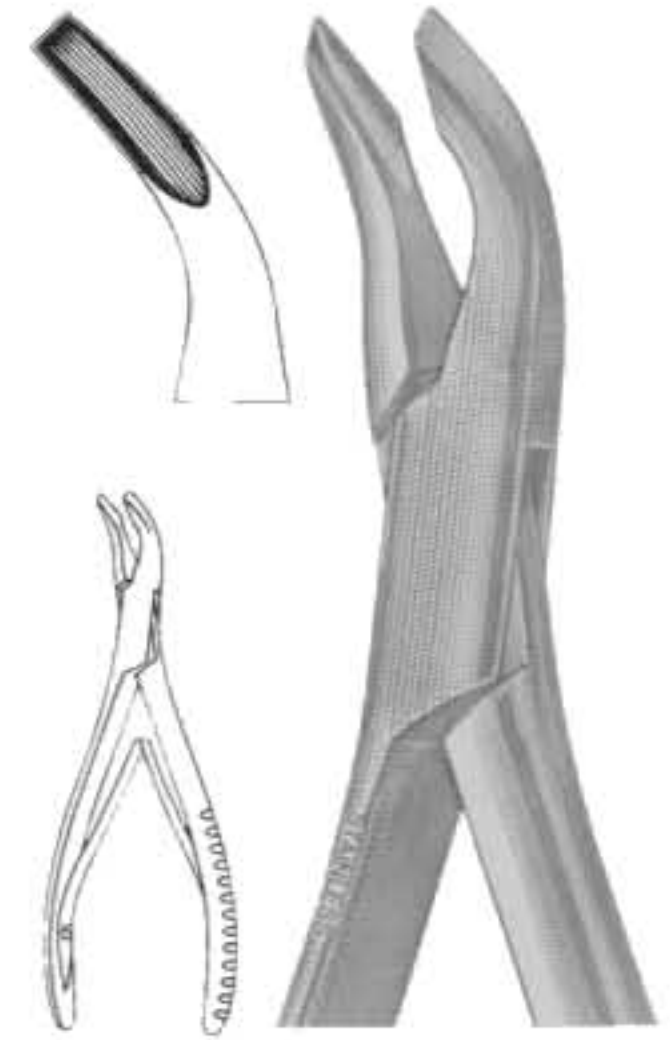

**2756**  
MEAD, Square  
No. 2A  
Tips, 6 1/2"

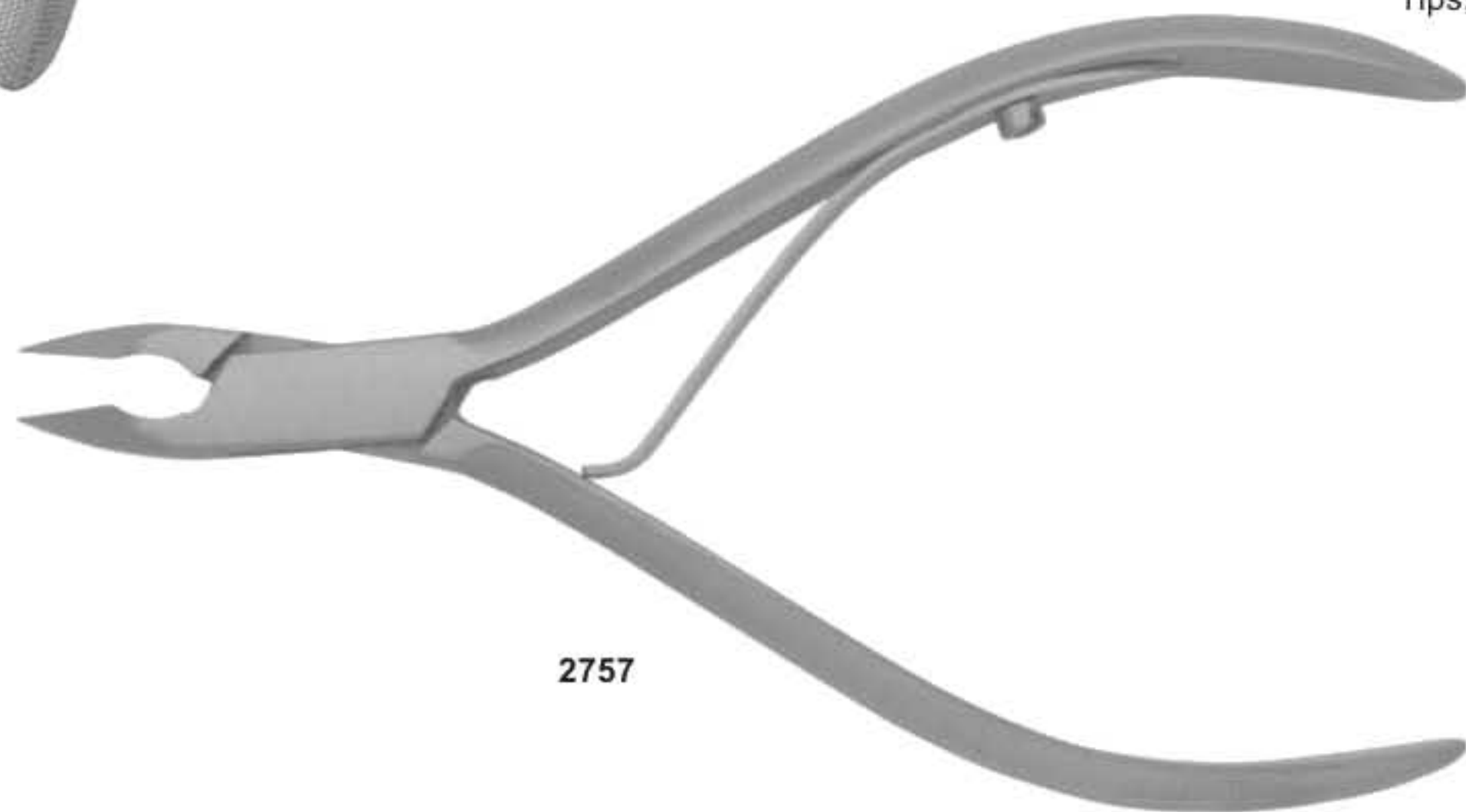

**2757**



**2757**  
FRIEDMAN  
5 1/2"

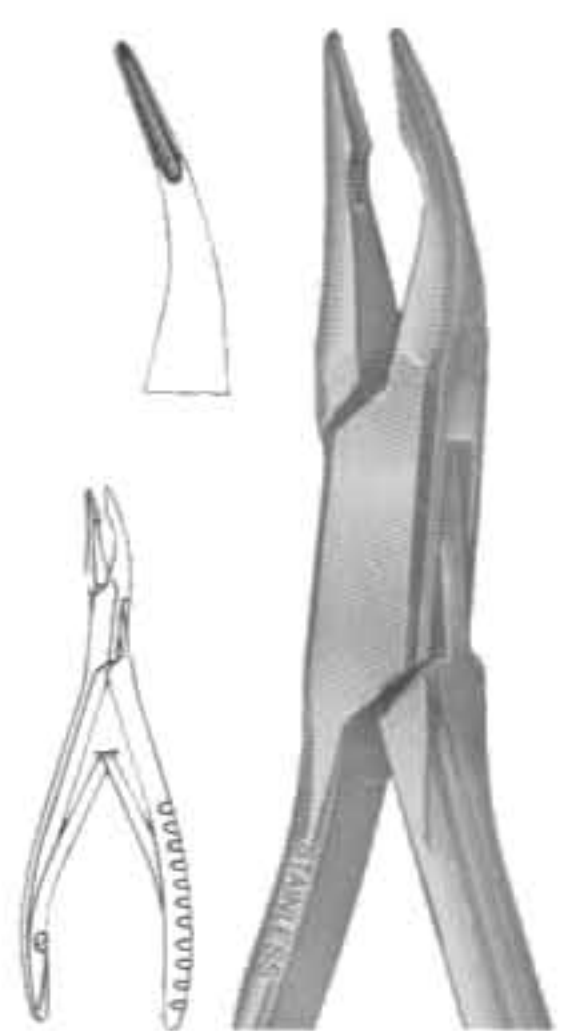

**2758**  
MICRO-FRIEDMAN  
5 1/2", 15° Curved Jaws



**2759**  
MICRO-FRIEDMAN  
Perio Rongeur, 5 1/2"

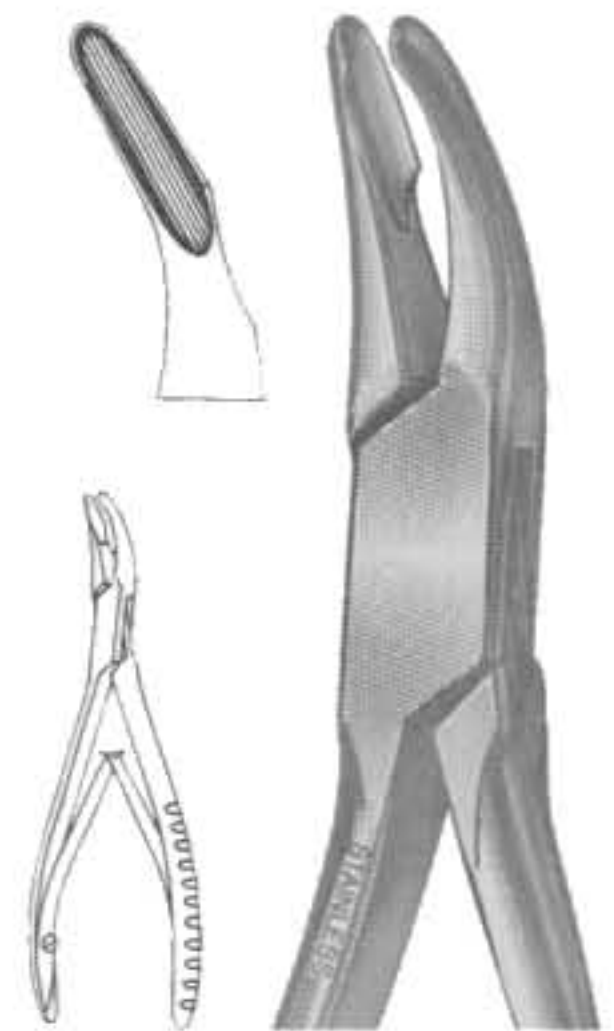

**2760**  
CLEVELAND  
No. 4 - 5 1/2"

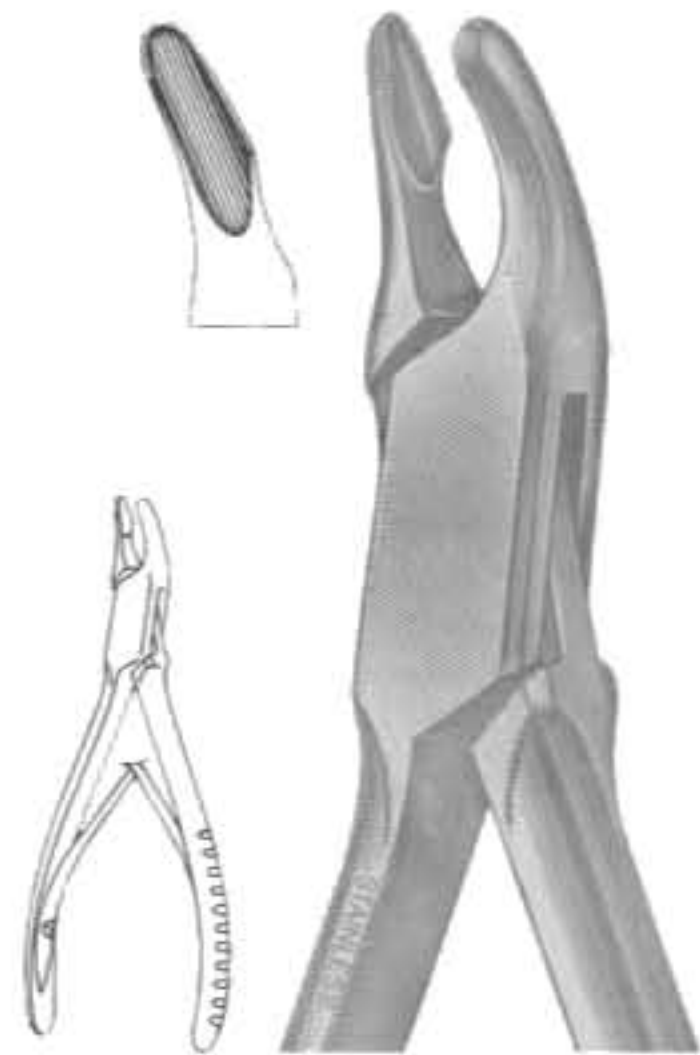

**2761**  
CLEVELAND  
No. 4A - 6 1/2"

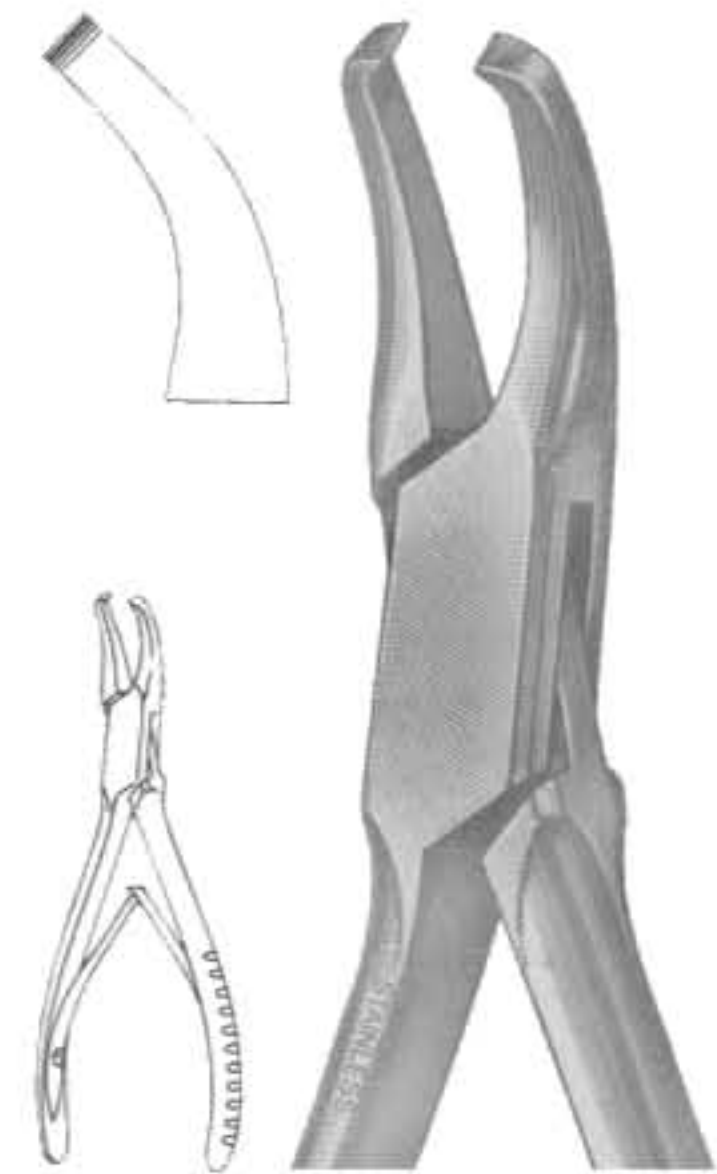

**2762**  
GARDNER  
No. 6A, End Cutting  
6 1/2"



**2763**  
BEYER  
Double Action,  
16,18 cm



**2764**  
No. 1  
6 1/2"

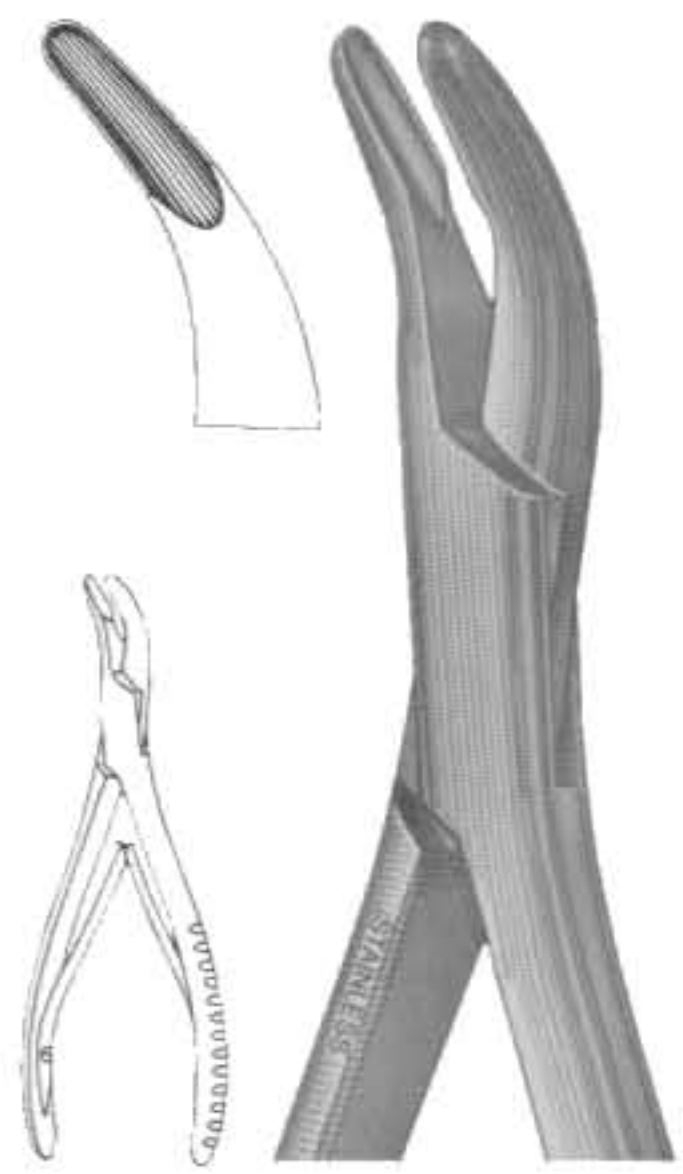

**2765**  
HARTMAN  
5 3/4"  
Strong Curve

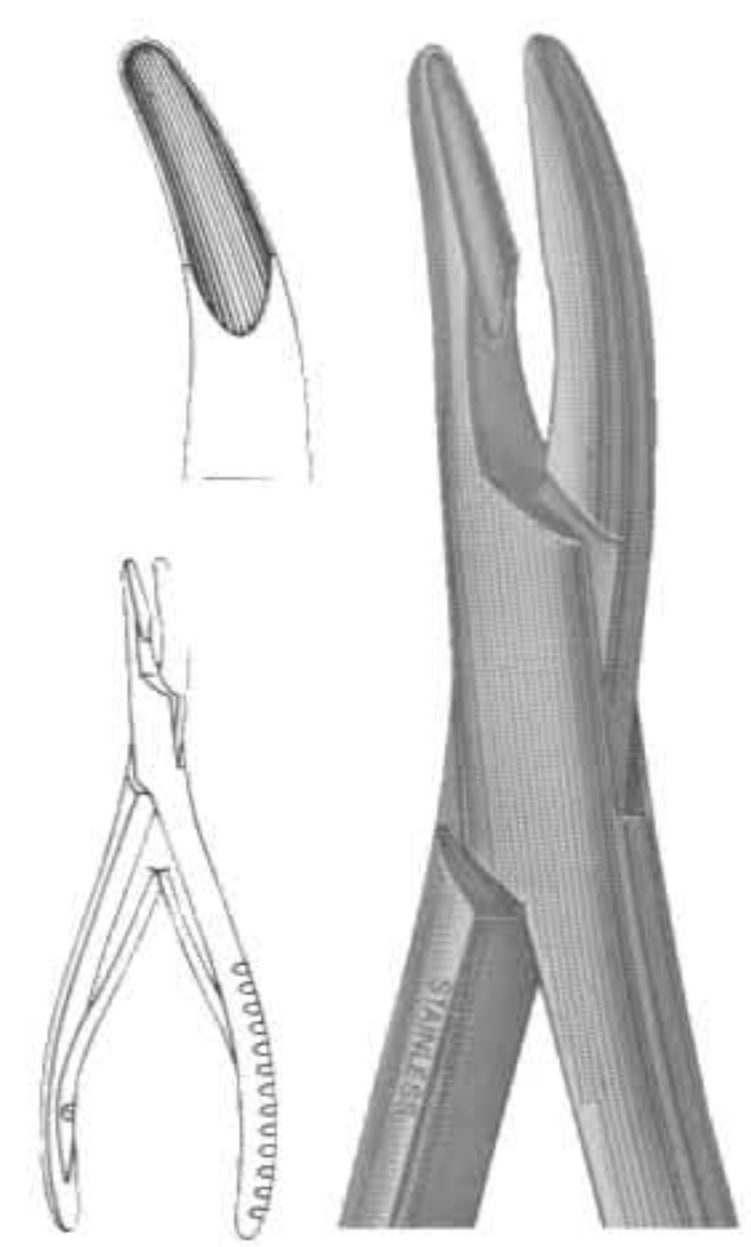

**2766**  
BANE  
Slight Curve  
7"



**2767**  
COLLIER  
5", Fenestrated Jaws



**2768**  
DERF  
4 3/4"



**2769**  
WEBSTER  
Delicate Smooth Jaws  
5"

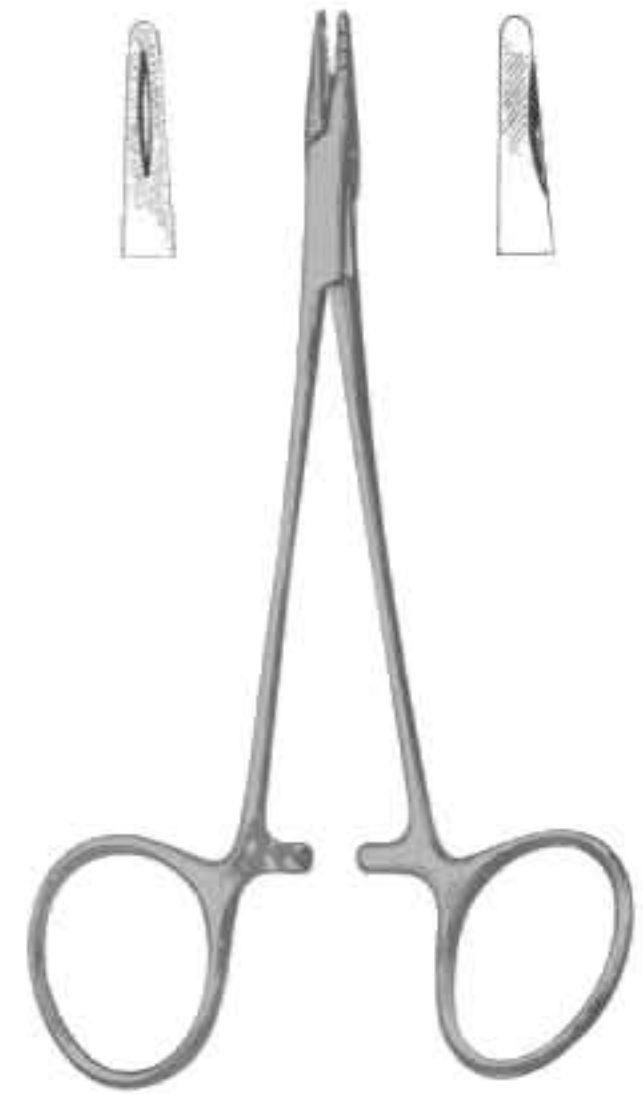

**2770**  
NEIVERT  
One Offset Ring  
5"



**2771**  
OLSEN-HEGAR  
5 1/2"



**2772**  
BAUMGARTNER  
5 1/2"



**2773**  
CRILE-WOOD  
6"



**2774**  
GARDNER  
5"

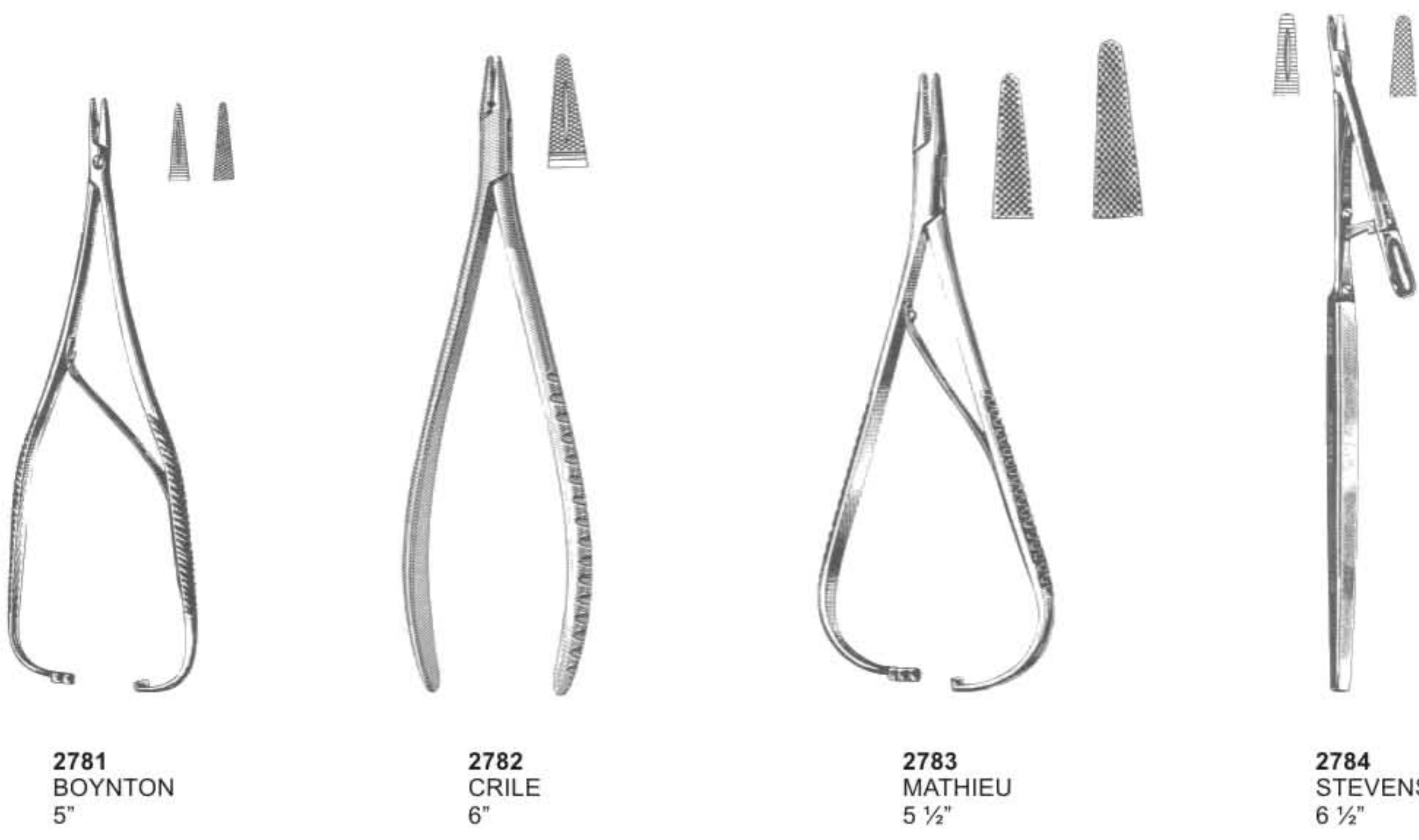
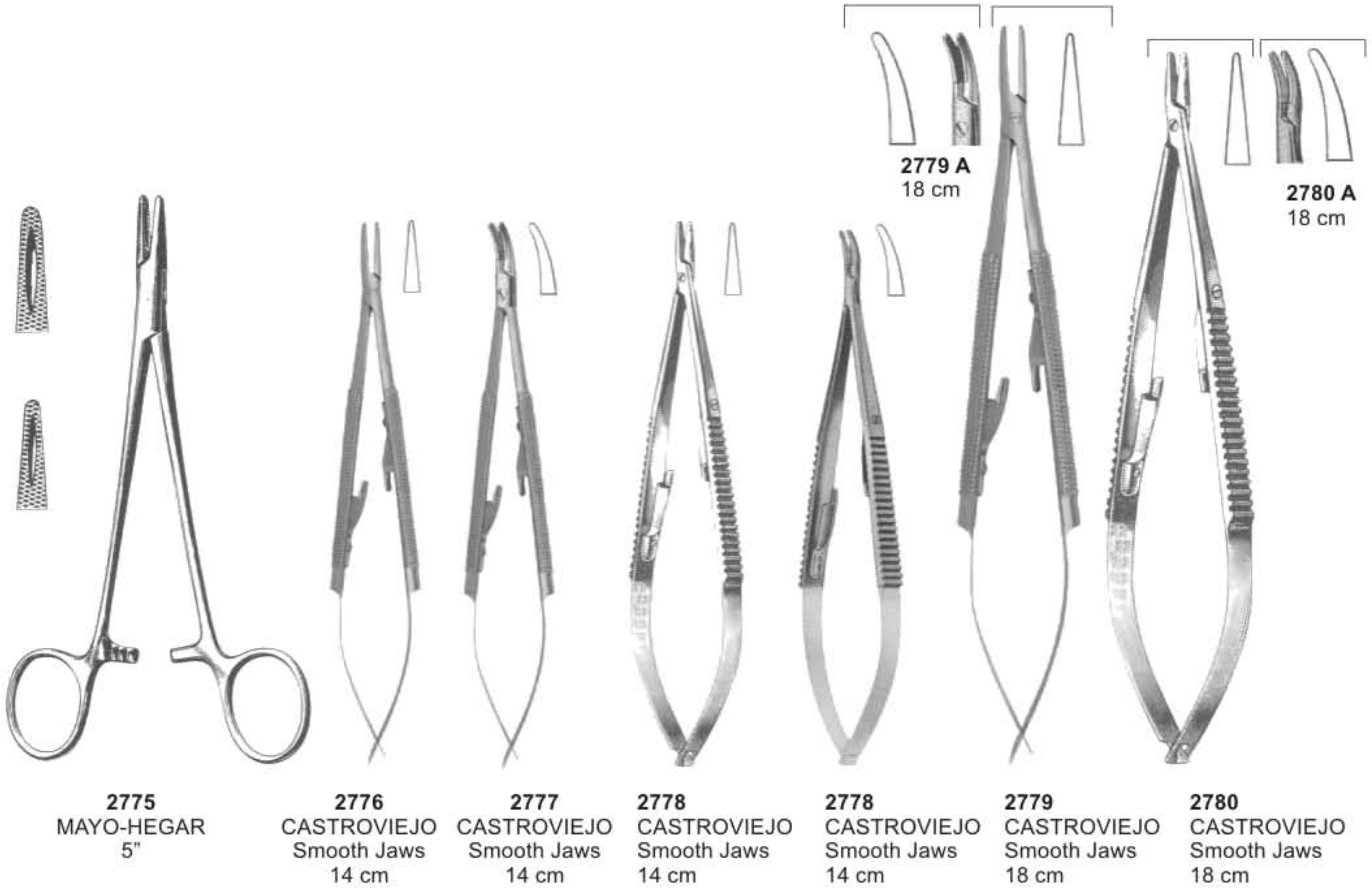

**2781**  
BOYNTON  
5"

**2782**  
CRILE  
6"

**2783**  
MATHIEU  
5 ½"

**2784**  
STEVENS  
6 ½"





**2785**  
Micro Scissor  
Straight, 155 mm



**2786**  
Micro Scissor  
Straight, 150 mm



**2787**  
Micro Scissor  
Curved, 150 mm



**2788**  
Micro Scissor  
Curved, 155 mm

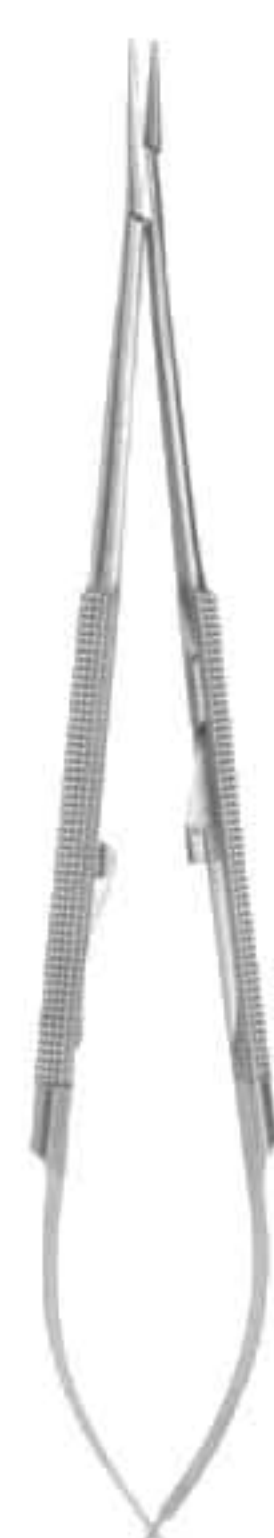

**2789**  
CASTROVIEJO  
T.C.  
Straight, 180 mm



**2790**  
Retractor  
Fig.3  
165 mm



**2791**  
Micro Adson  
120 mm



**2792**  
GERALD  
Curved,  
180 mm







**2793**  
GERALD  
Straight,  
175 mm

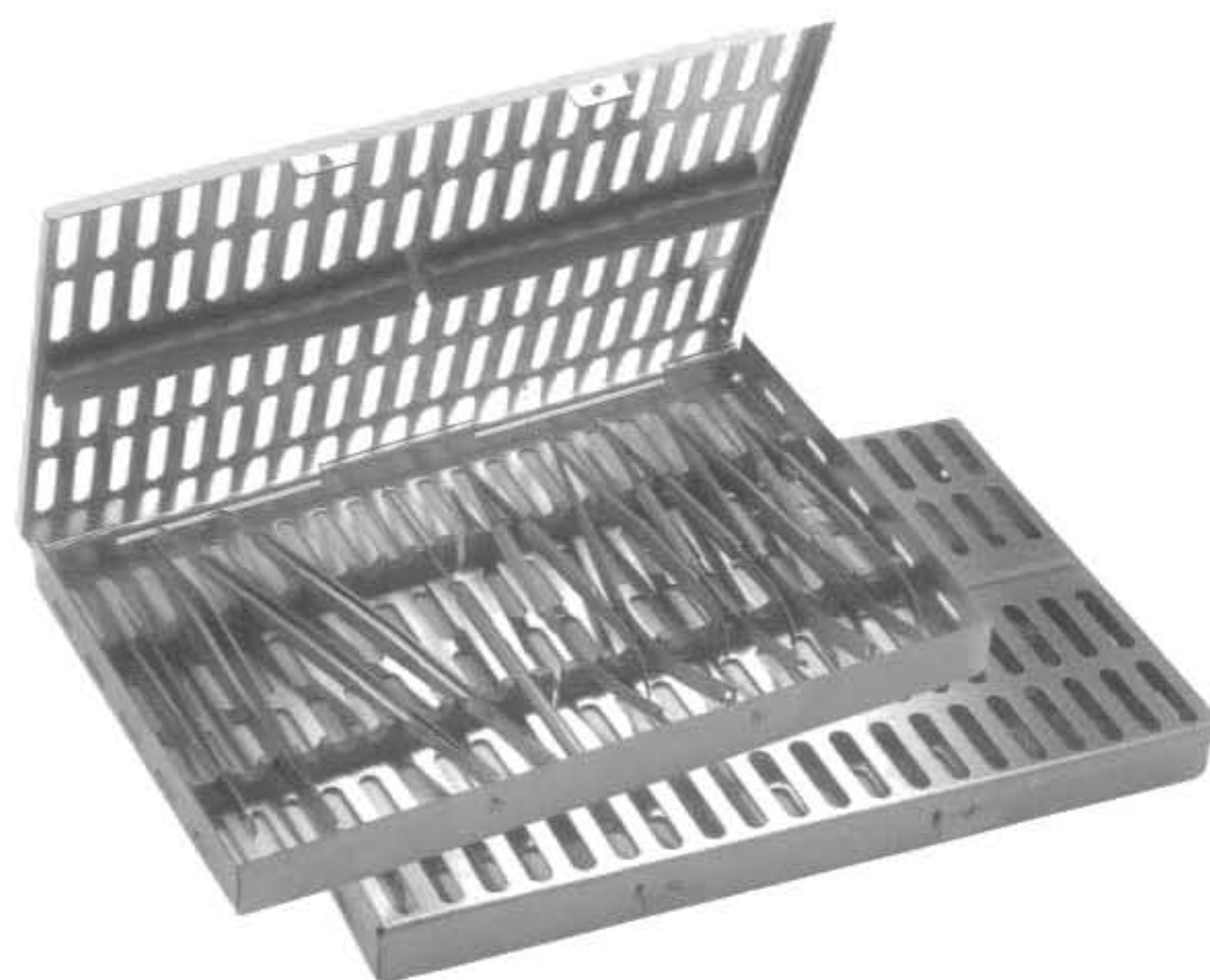

**2794**  
Micro Adson  
160 mm



**2795**  
Micro Surgery Set 10 Pieces.

-  Scissors
-  Impression Trays
-  Articulators
-  Hollow Wares
-  T.C. Instruments

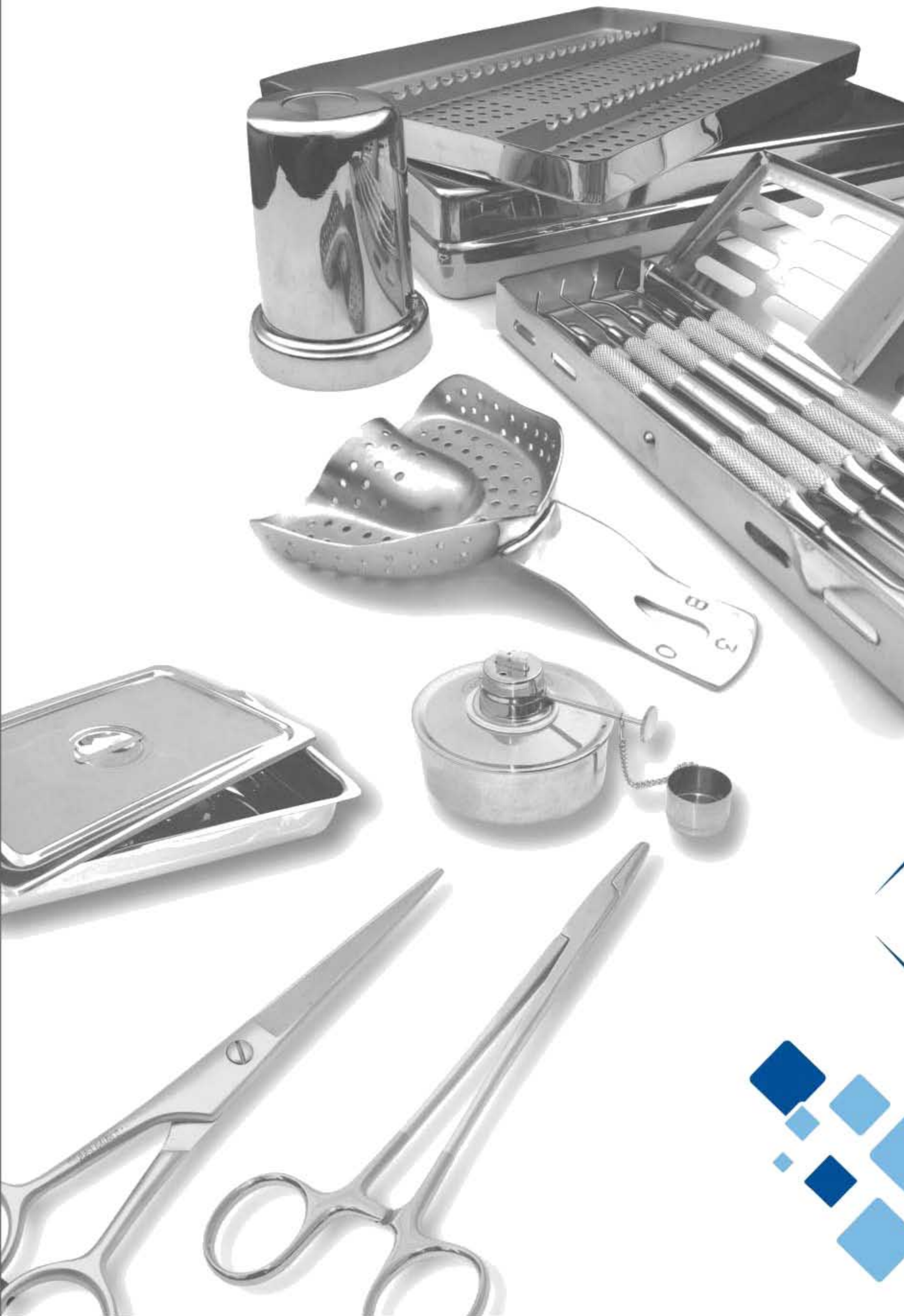

# 08

SECTION



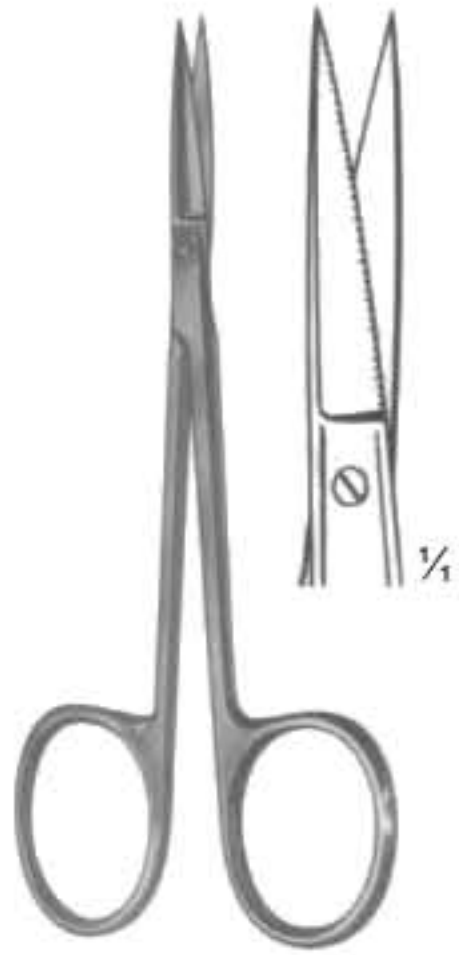

**2796**  
IRIS (Standard)  
Straight  
11.5 cm, 4 1/2"

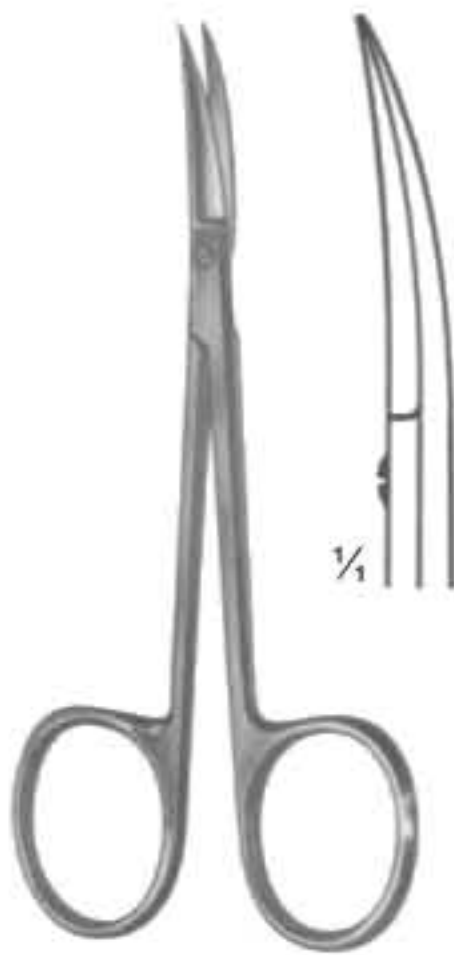

**2797**  
IRIS (Standard)  
Curved  
11.5 cm, 4 1/2"



**2798**  
STEVENS  
Dissecting Scissors  
Size: 115 mm



**2799**  
Sharp

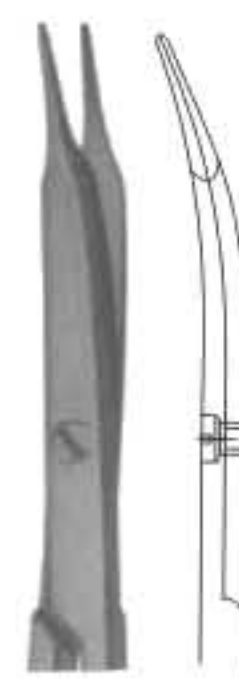

**2800**  
Sharp



**2801**  
Blunt

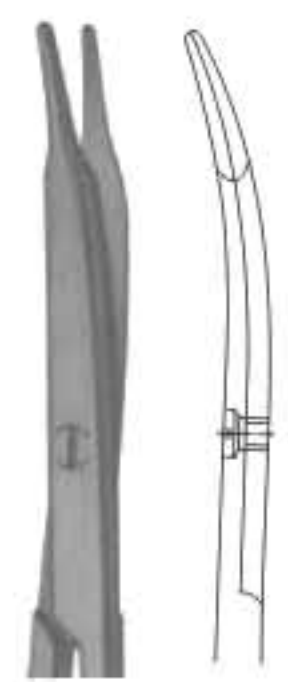

**2802**  
Blunt



**2803**



**2804**  
JOSEPH  
Size: 150 mm

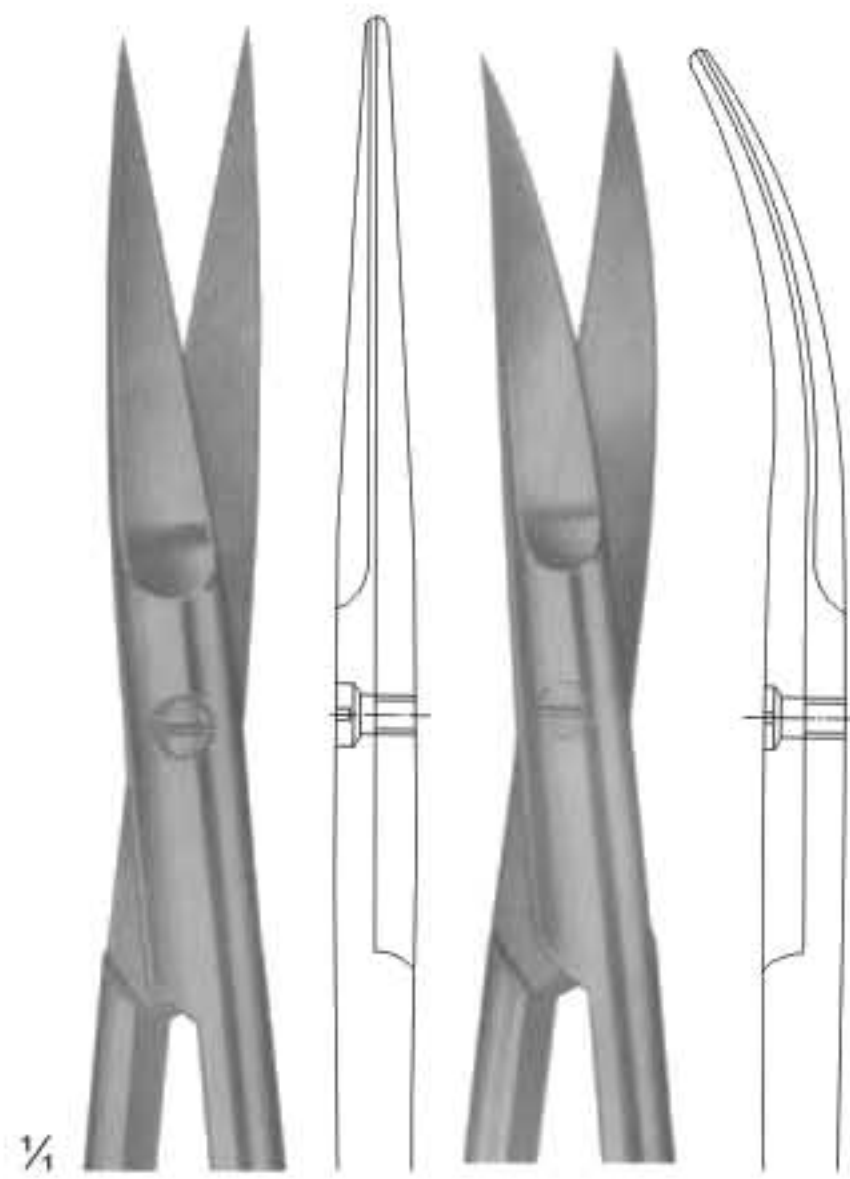

**2805**

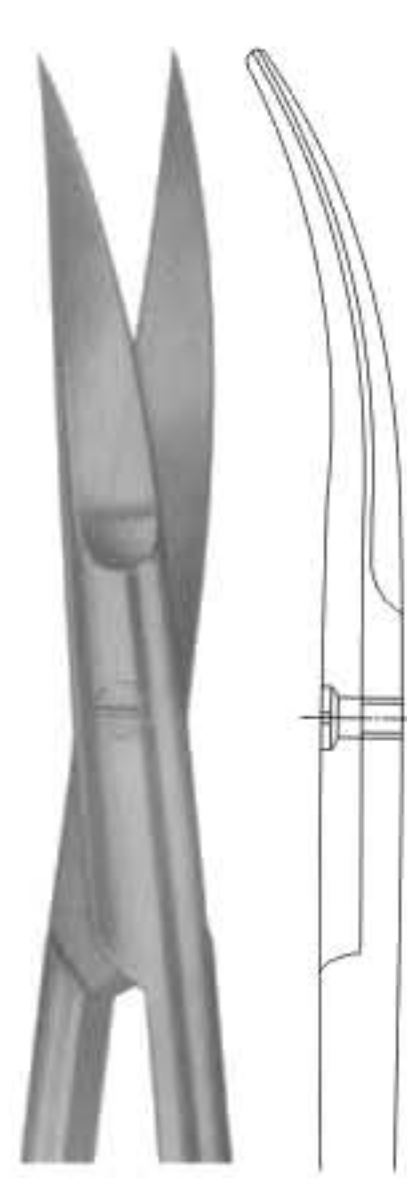

**2806**

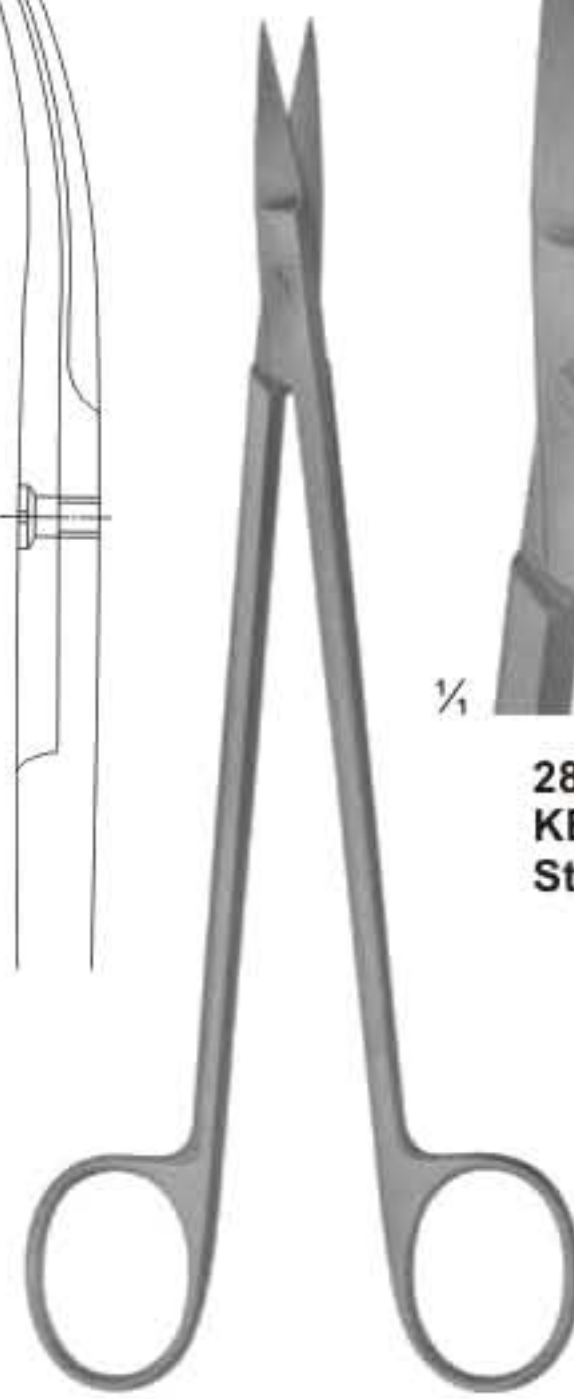

**2807**  
KELLY  
Size: 175 mm

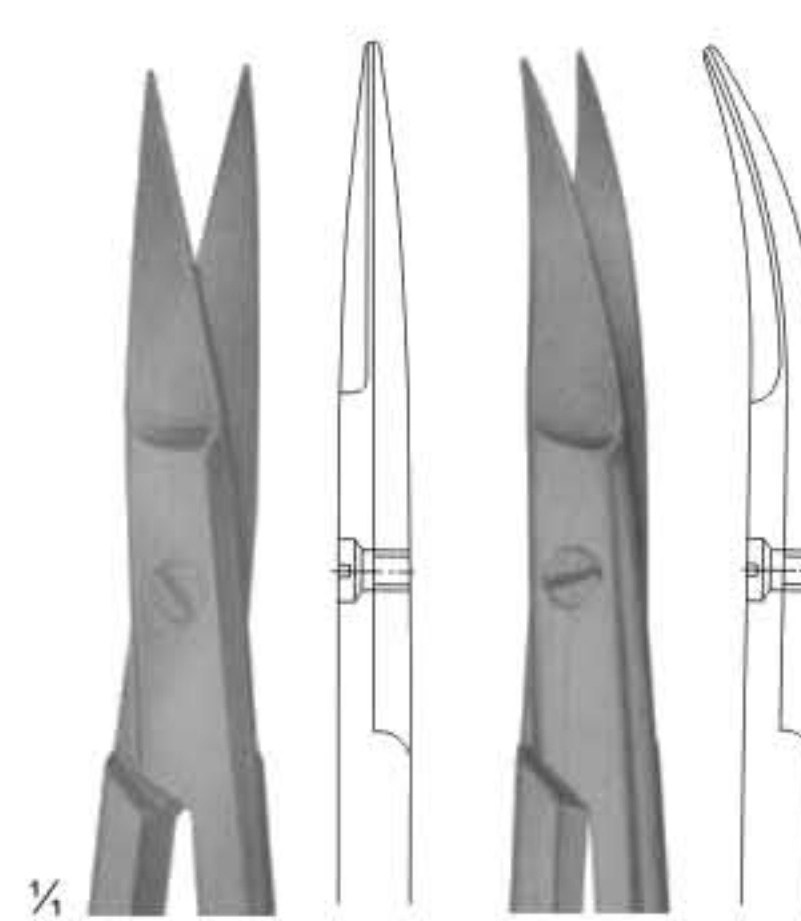

**2808**  
KELLY  
Straight

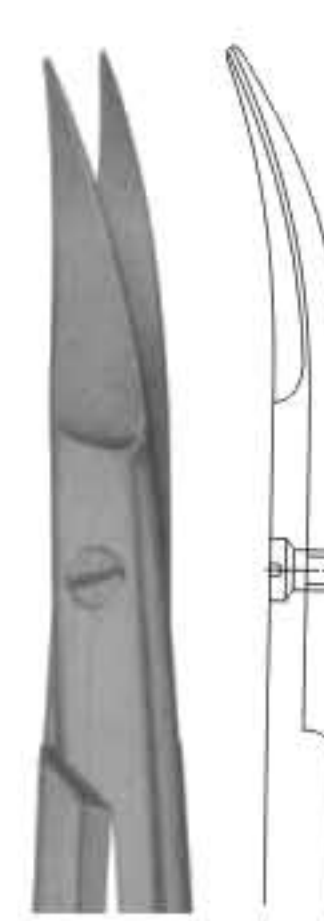

**2809**  
KELLY  
Curved

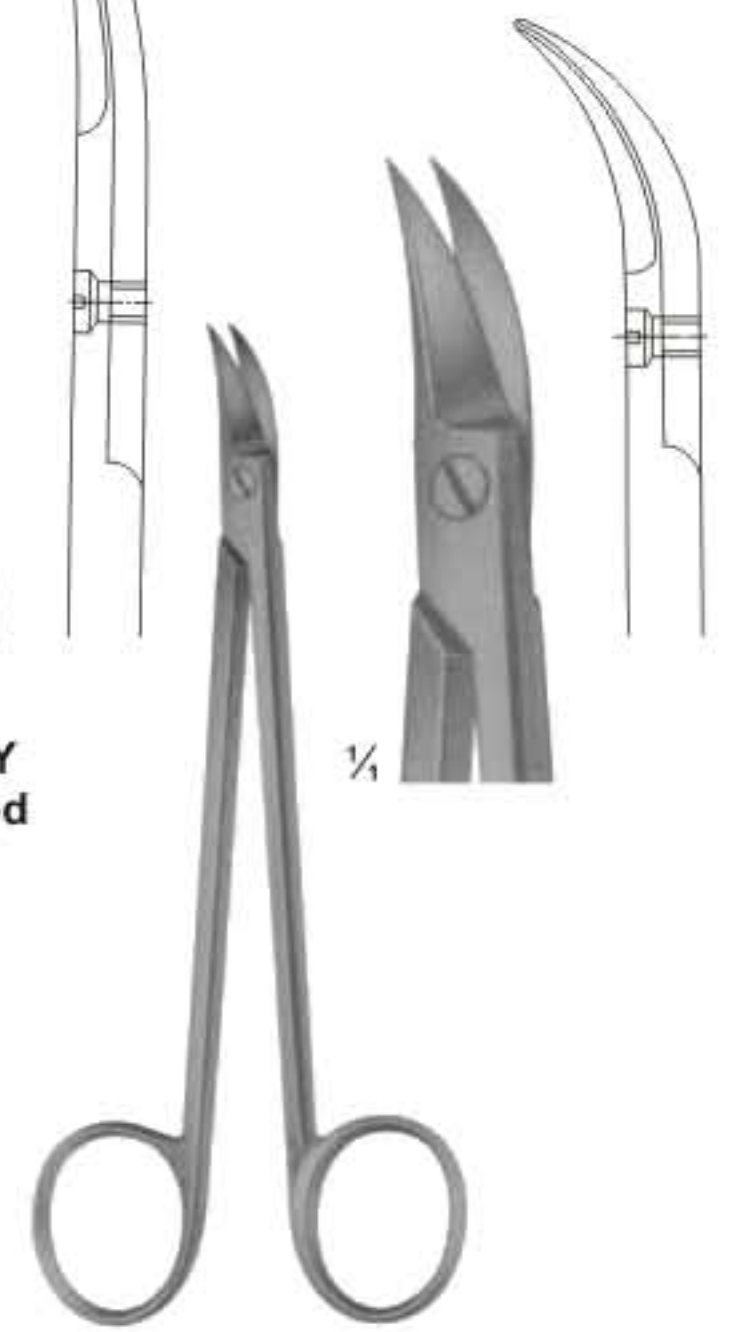

**2810**  
QUINBY  
Size: 130 mm

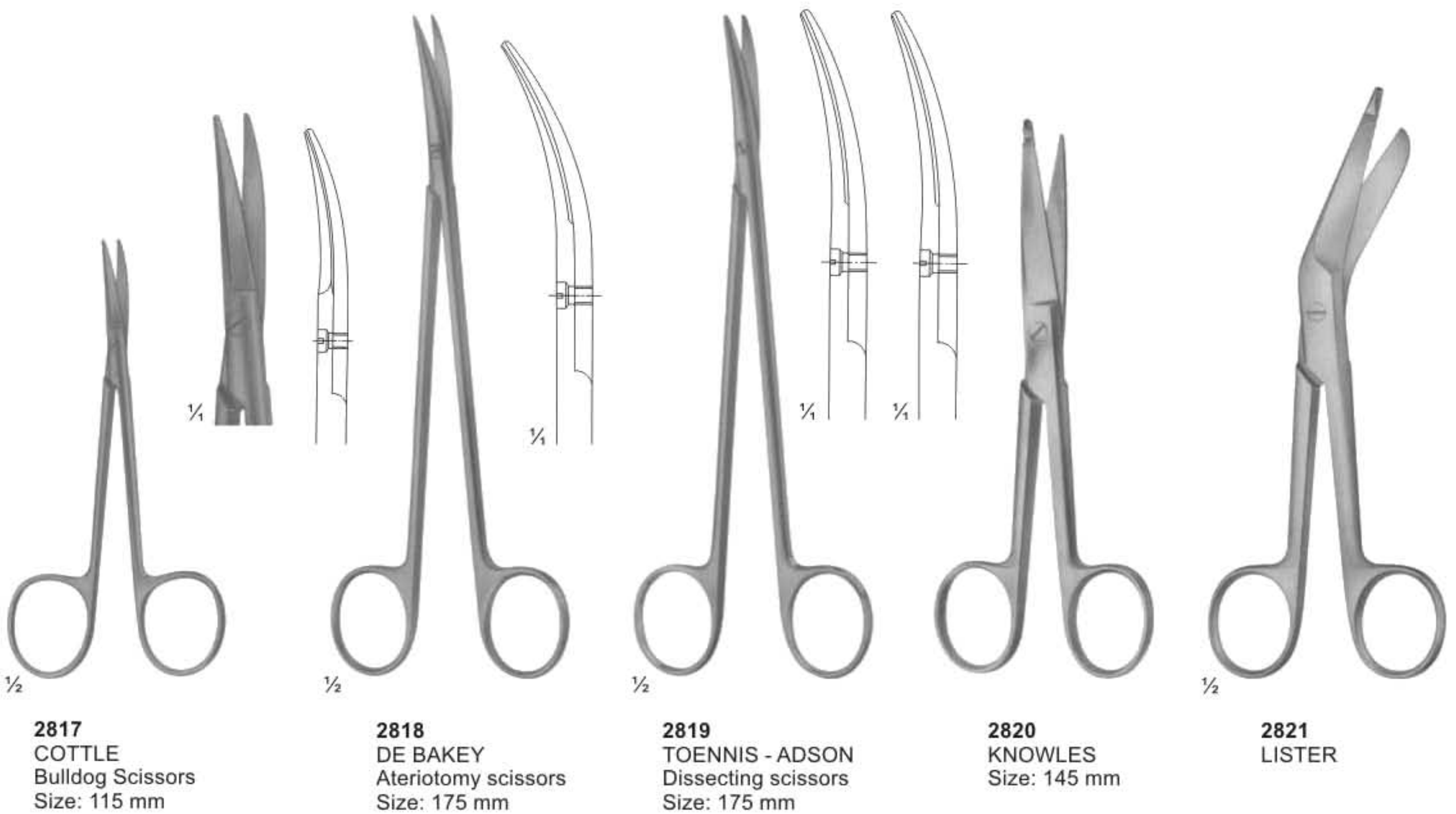
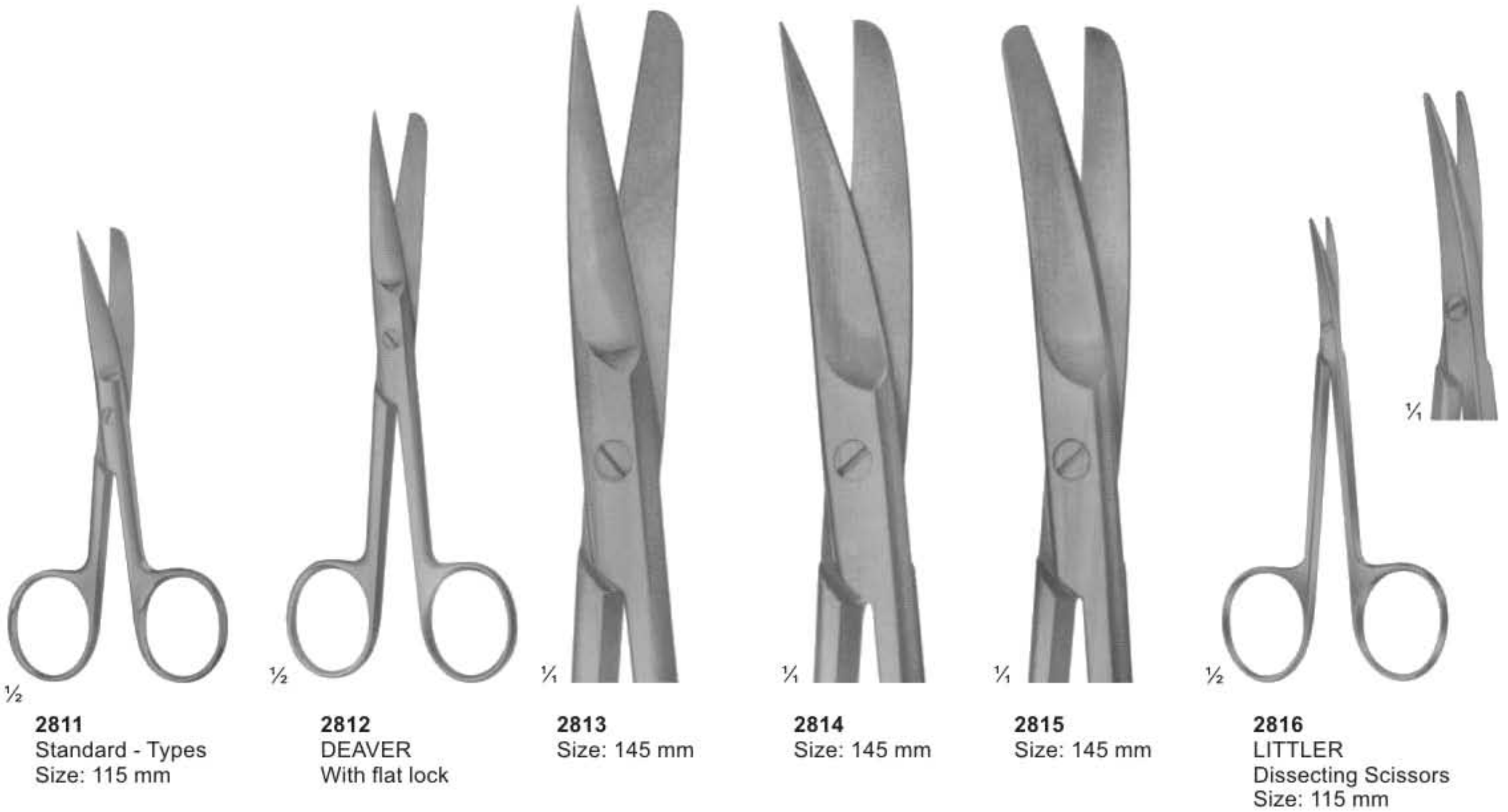

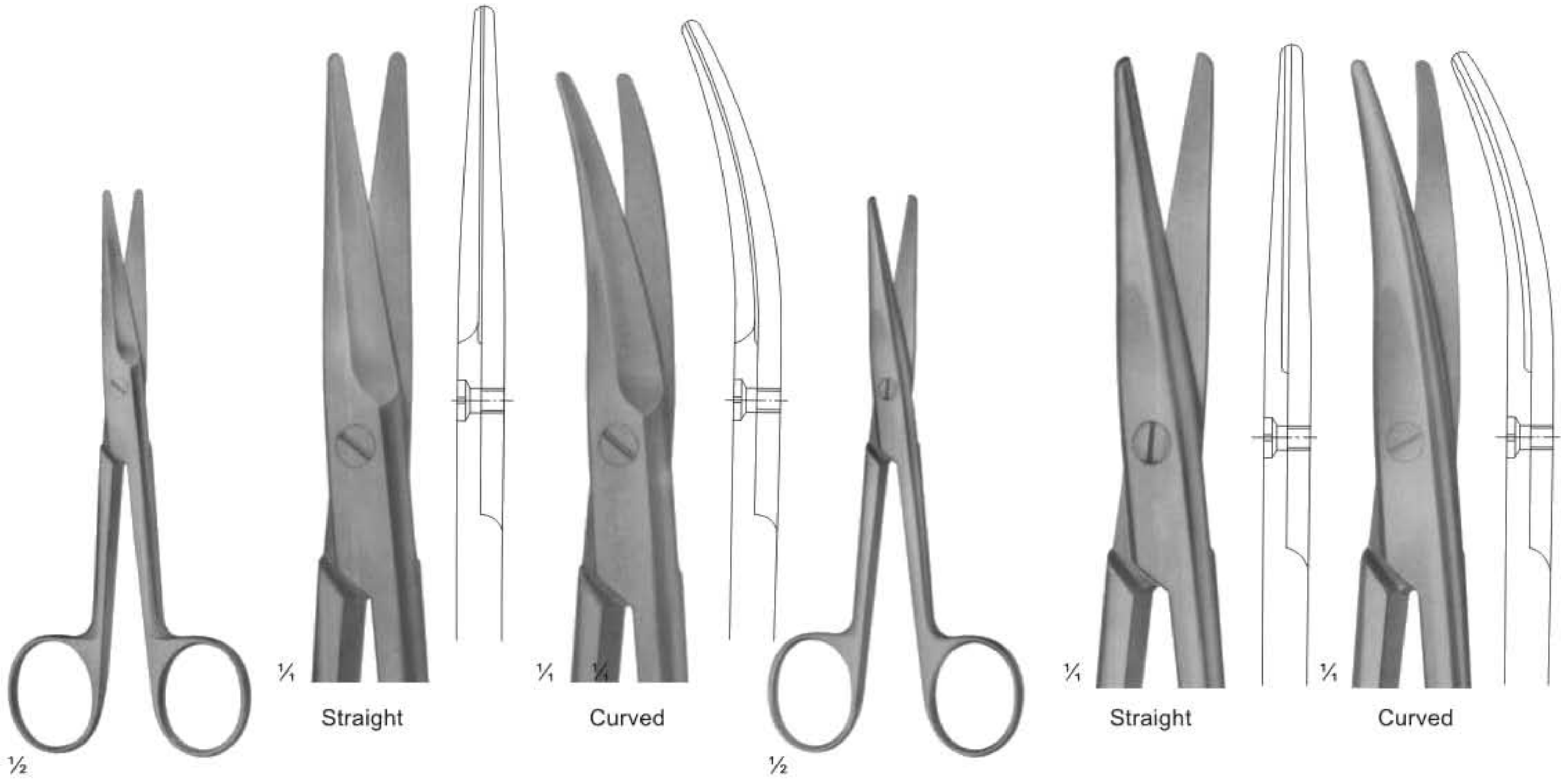

**2822**  
MAYO(straight)  
Size: 140 mm

**2823**  
MAYO-STILLE (straight)  
Size: 140 mm

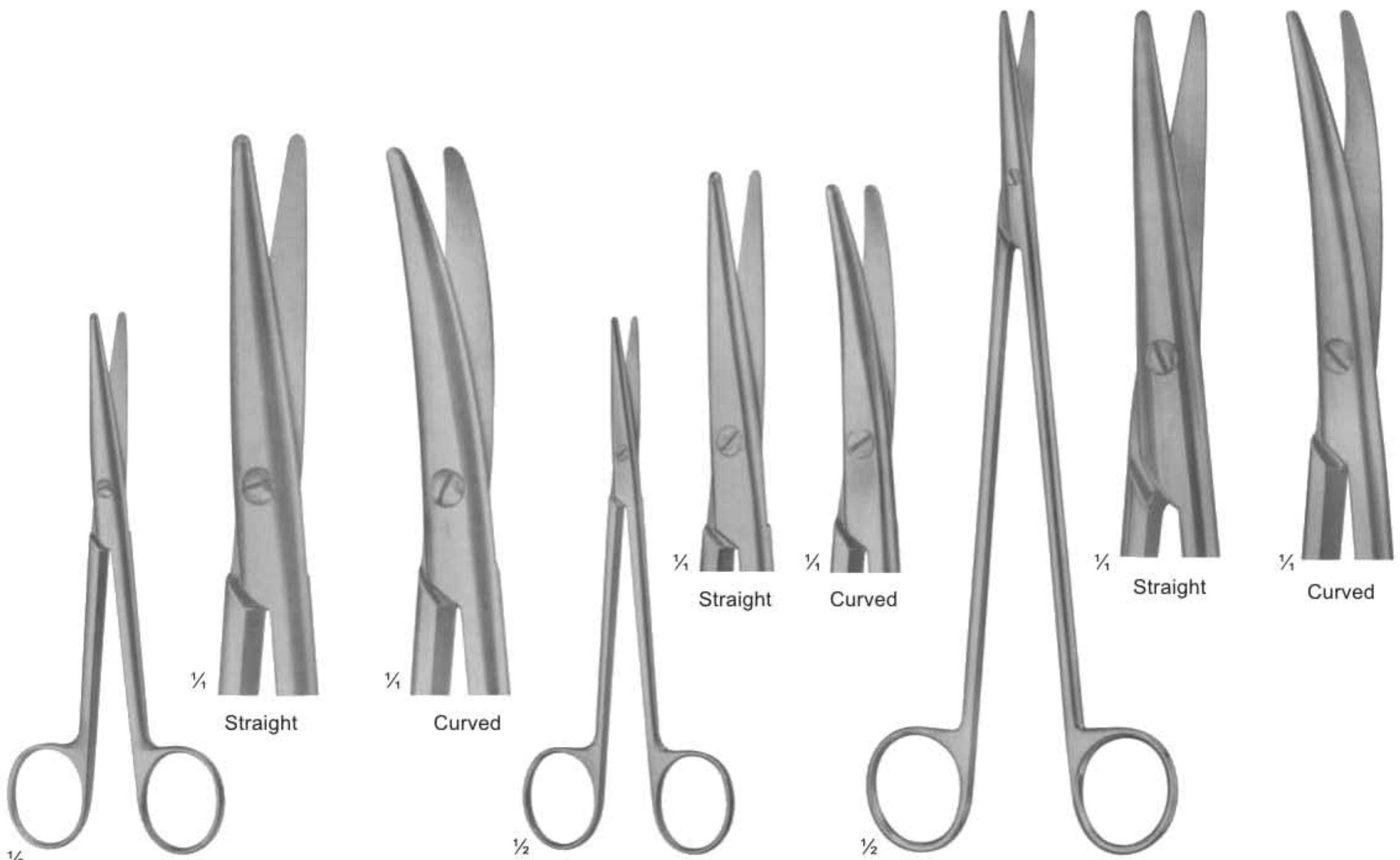

**2824**  
STILLE  
Size: 140 mm

**2825**  
METZENBAUM  
Size: 145 mm

**2826**  
NELSON-METZENBAUM  
Size: 230 mm

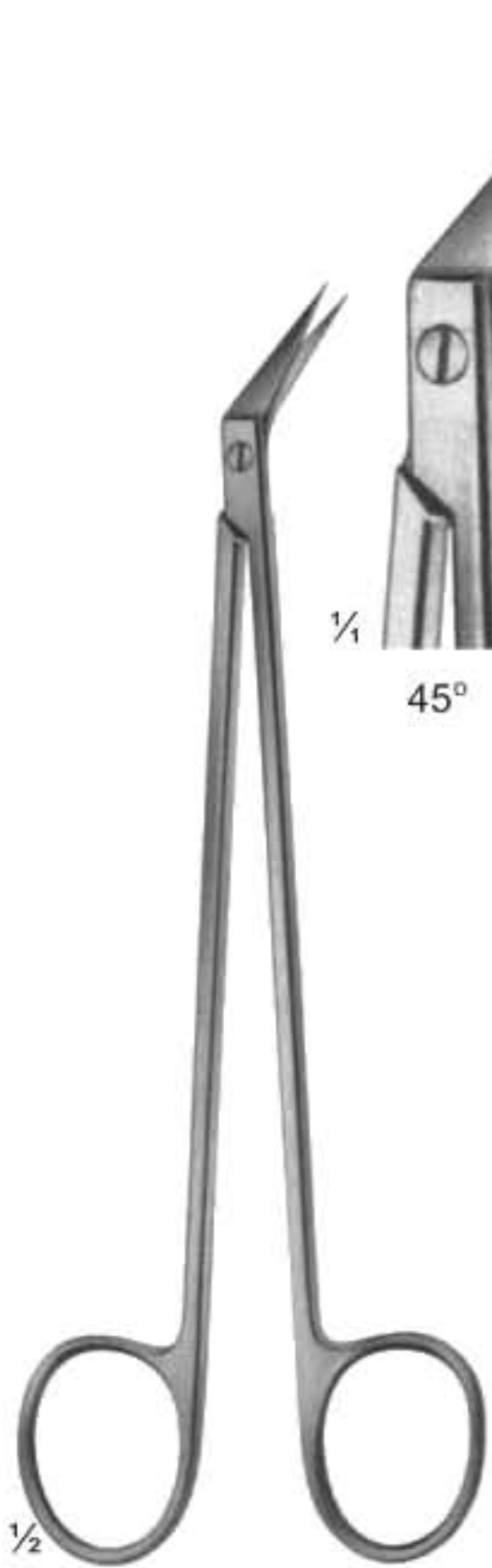

**2827**  
DE BAKEY  
Size: 155 mm



**2828**  
LOCKLIN  
Curved Sideways,  
1 Toothed Blade  
Size: 155 mm

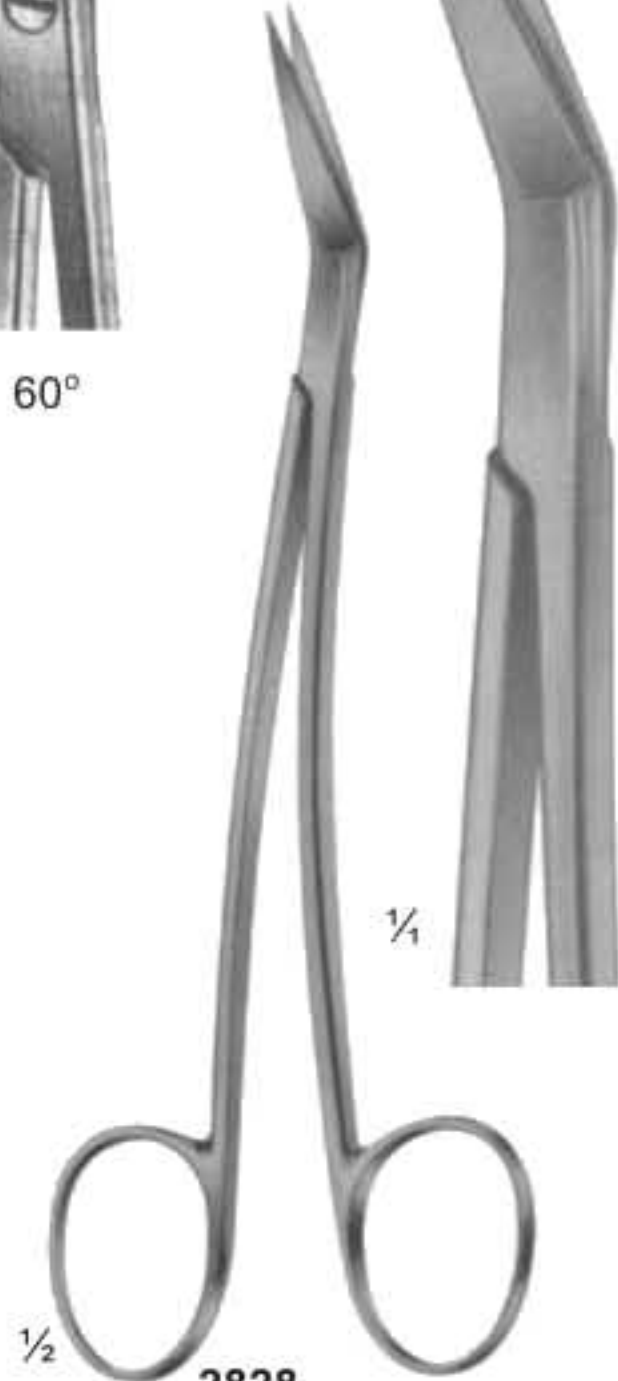

**2829**  
LaGrange  
Double-Curved  
11.5 cm



**2830**  
Goldman-Fox  
Double-Curved  
13cm



**2831**  
SPENCER  
Size: 90 mm

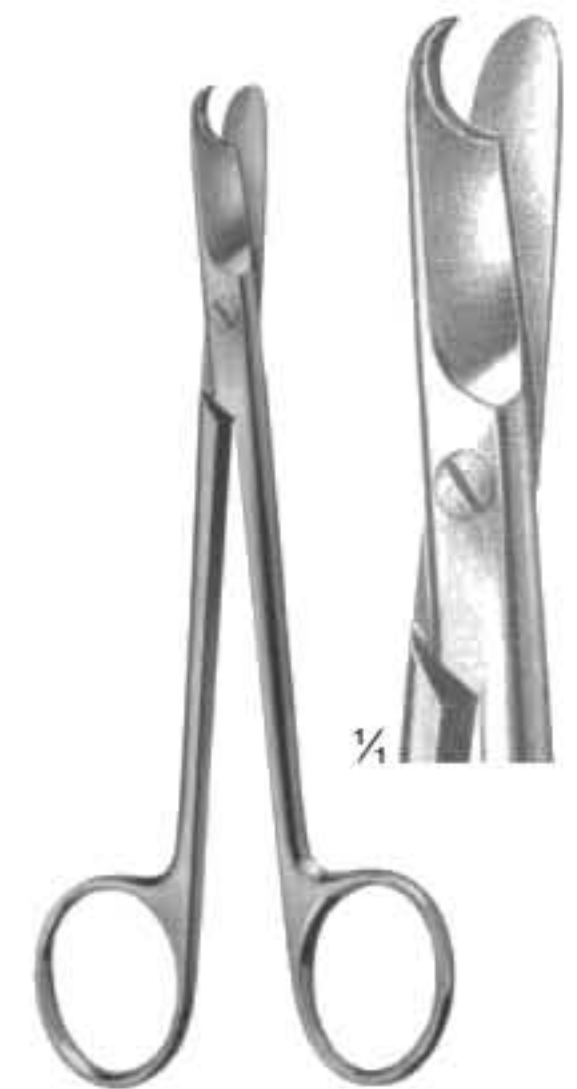

**2832**  
LITTAUER  
Size: 135 mm

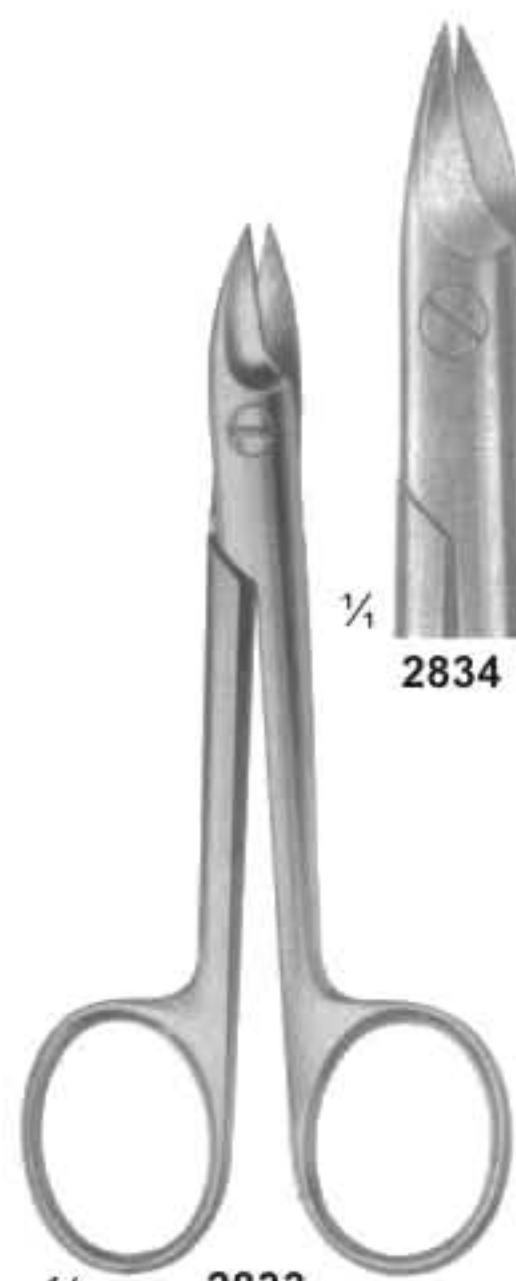

**2833**  
BEEBE  
Size: 110 mm

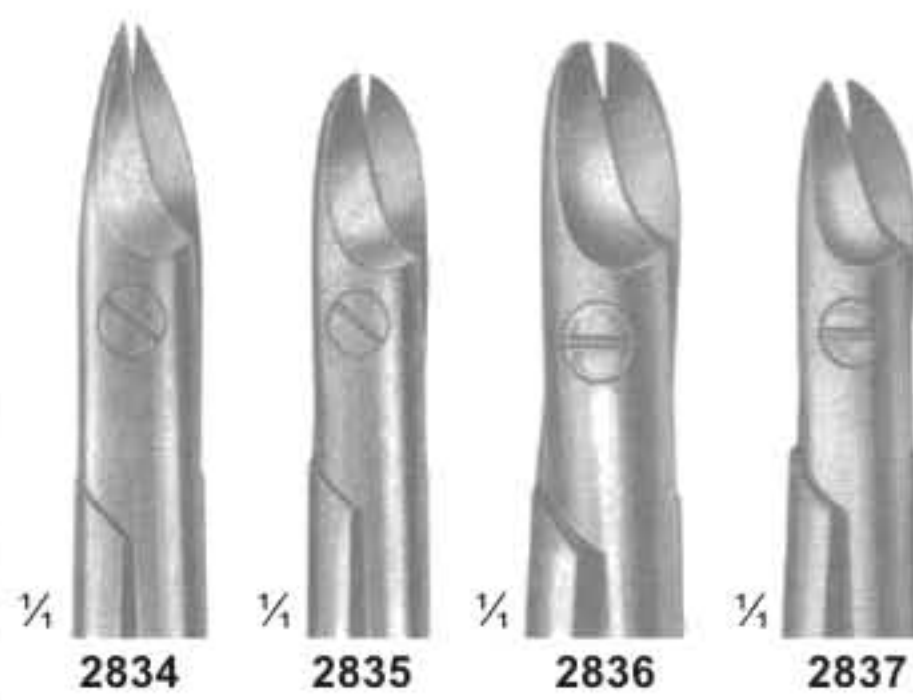

**2834**

**2835**

**2836**

**2837**



**2838**  
Dean  
17cm

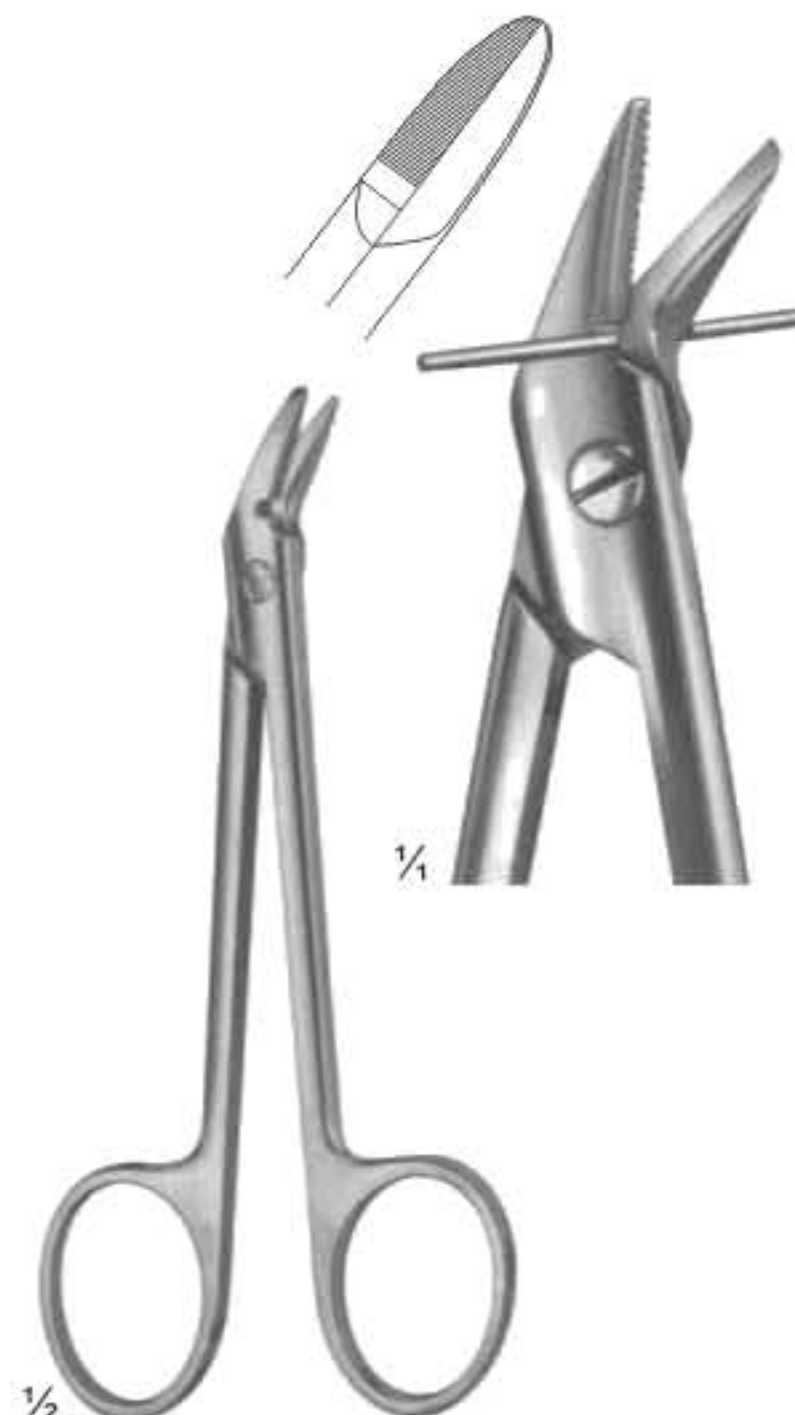

**2839**  
1 Blade Serrated  
Size: 120 mm

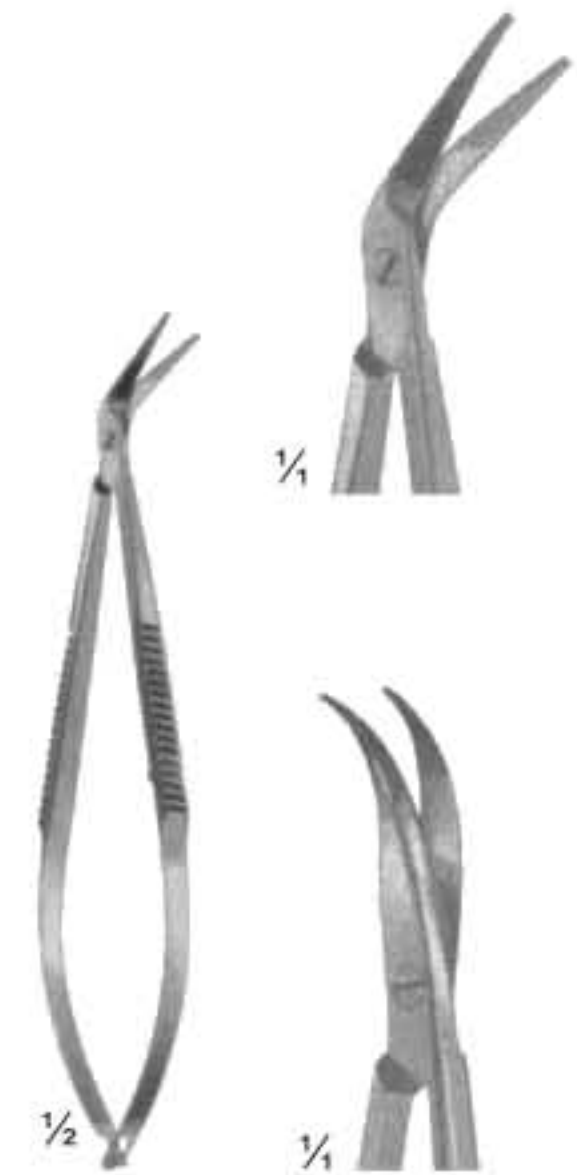

**2840**  
CASTROVIEJO  
Size: 90 mm

Made of 18/8 Stainless Steel, Solid, Set of 10

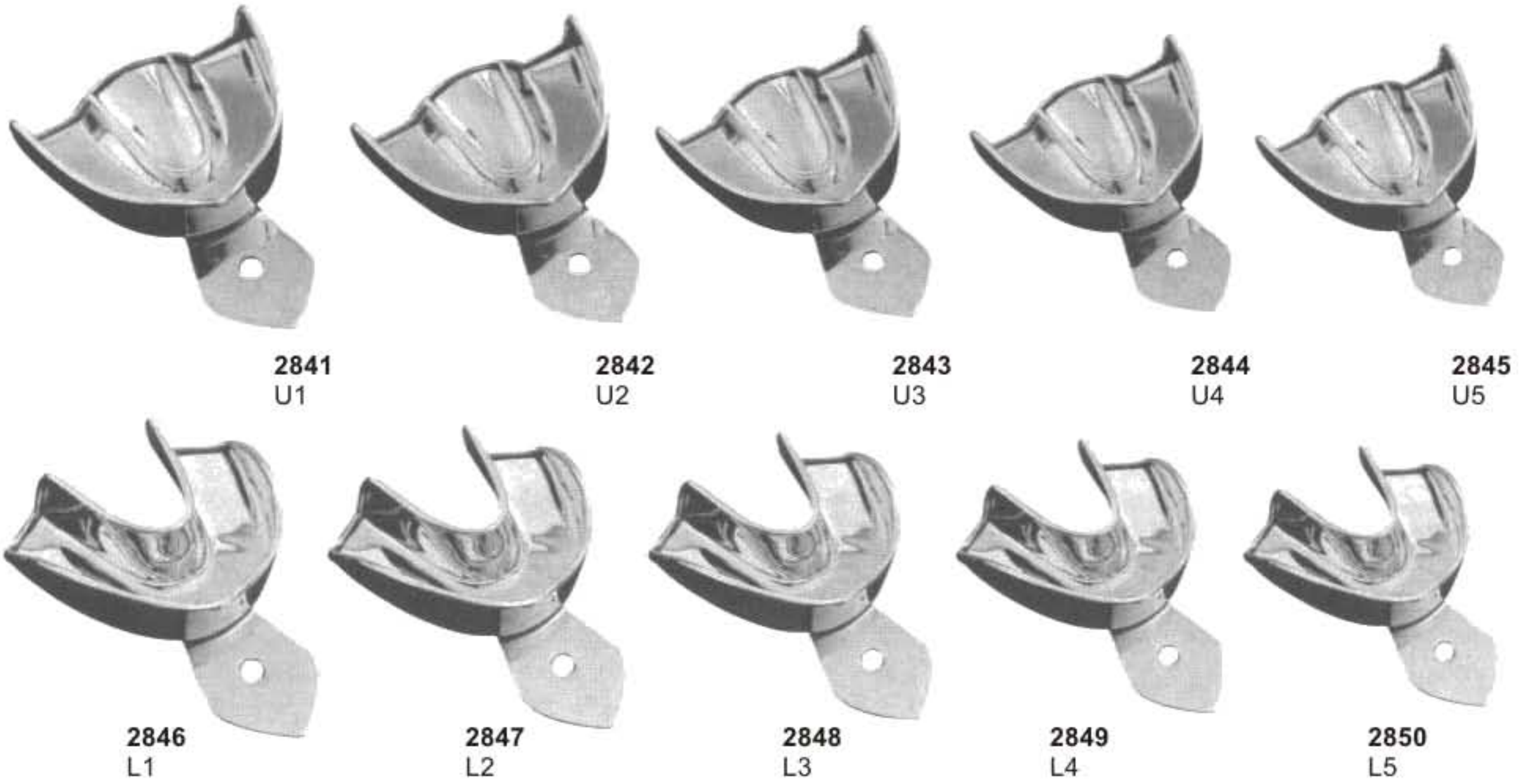

All The Above Impression Trays are Available in These 5 Sizes

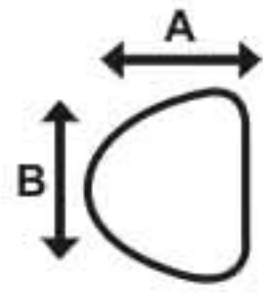

| UPPER |    | U1 | U2 | U3 | U4 | U5 |
|-------|----|----|----|----|----|----|
|       | A  | 62 | 60 | 53 | 54 | 52 |
| B     | 83 | 75 | 73 | 69 | 68 |    |

All Dimension are in mm

| LOWER |    | L1 | L2 | L3 | L4 | L5 |
|-------|----|----|----|----|----|----|
|       | A  | 63 | 61 | 57 | 60 | 53 |
| B     | 82 | 81 | 78 | 74 | 71 |    |

All Dimension are in mm

Perforated, Set of 10

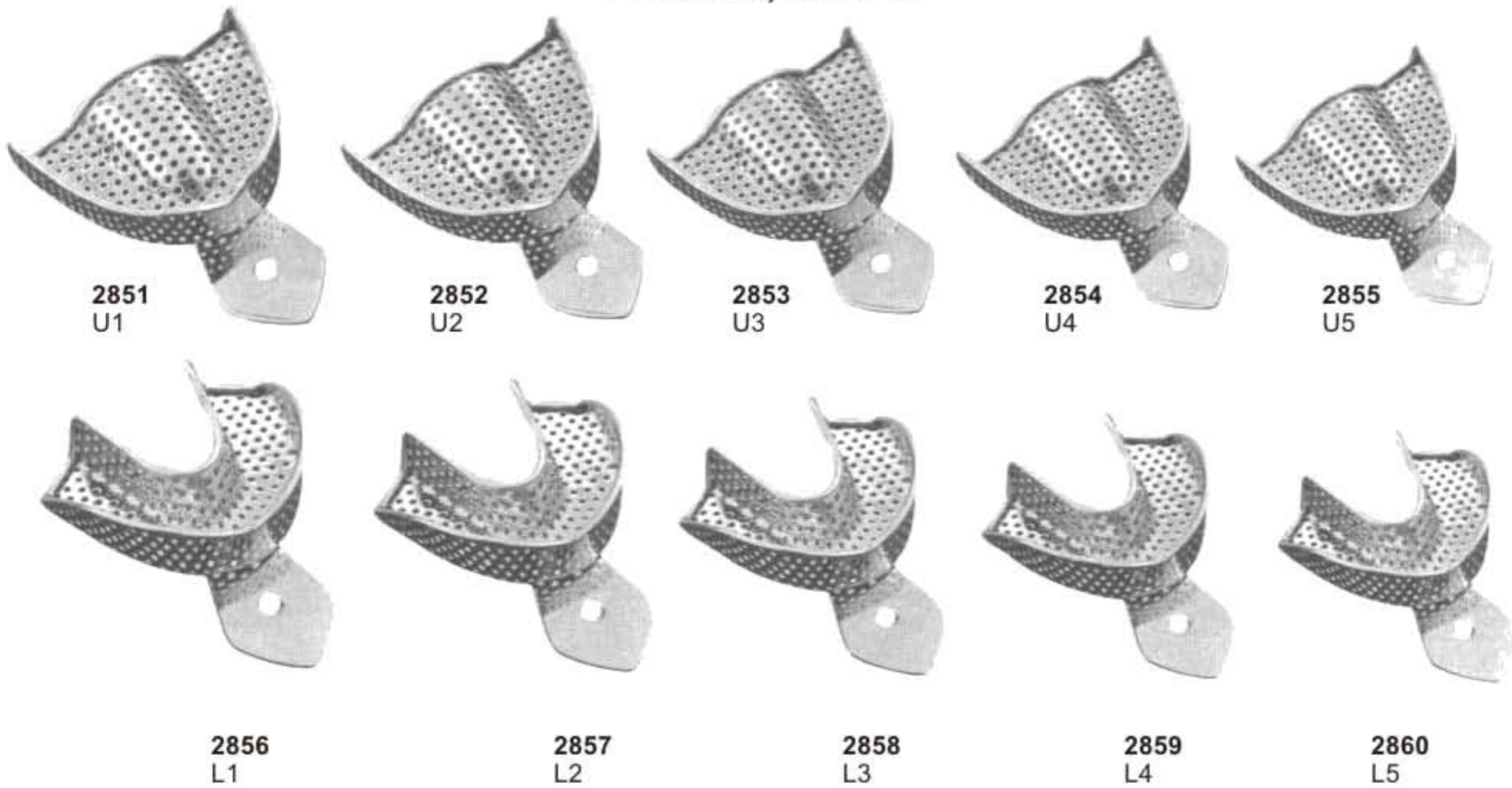

# Impression Trays

Made of 18/8 Stainless Steel, Solid Full Denture Set of 8

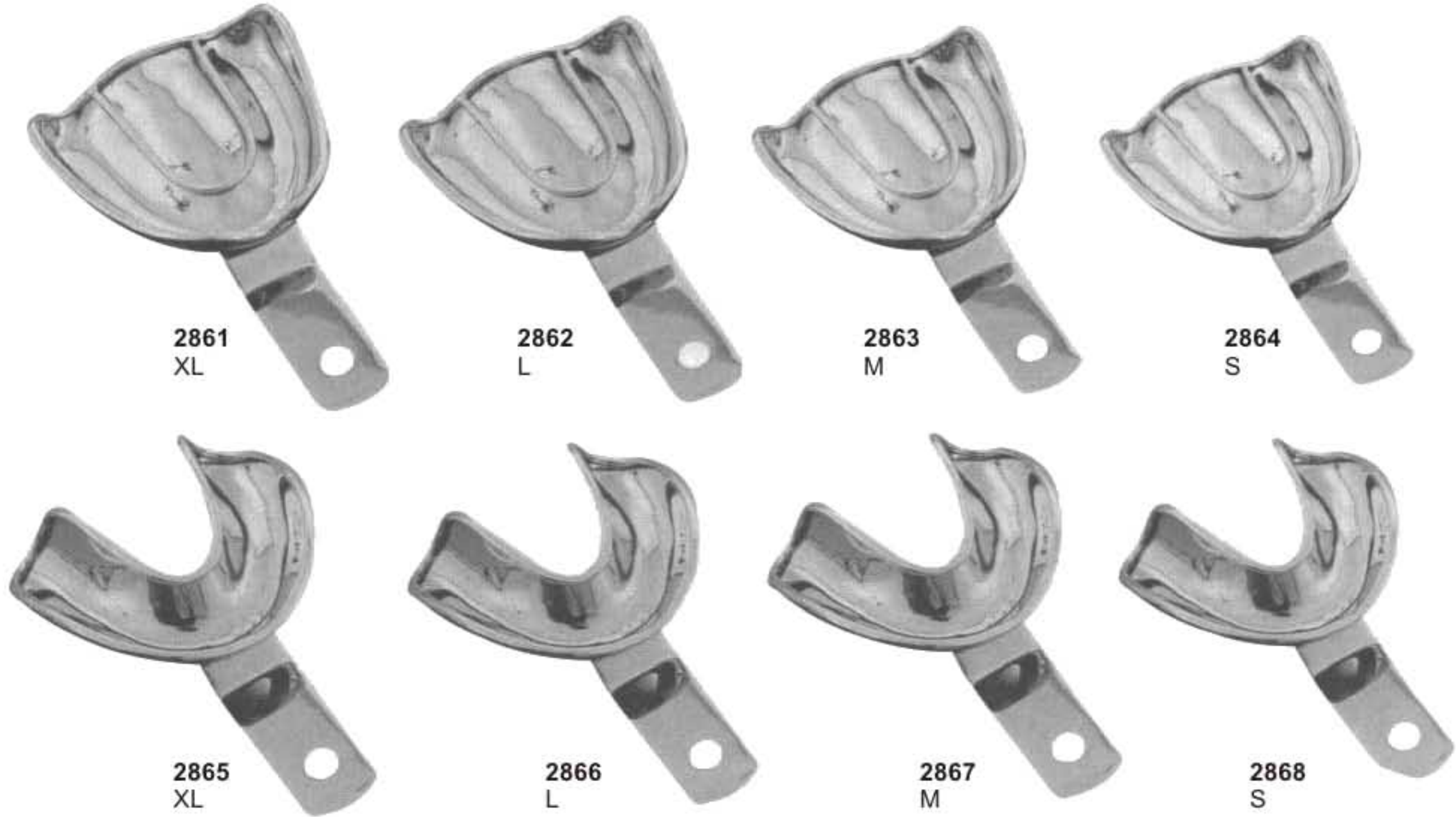

All The Above Impression Trays are Available in These 4 Sizes

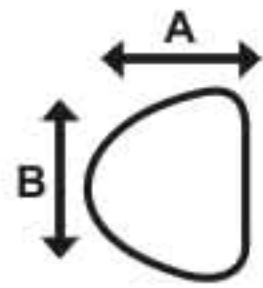

| UPPER | XL | L  | M  | S  |
|-------|----|----|----|----|
|       | A  | 70 | 67 | 64 |
| B     | 79 | 76 | 70 | 73 |

All Dimension are in mm

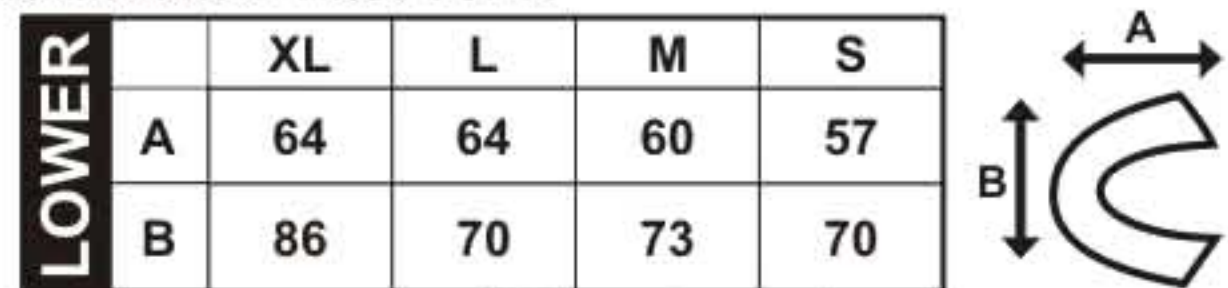

| LOWER | XL | L  | M  | S  |
|-------|----|----|----|----|
|       | A  | 64 | 64 | 60 |
| B     | 86 | 70 | 73 | 70 |

All Dimension are in mm

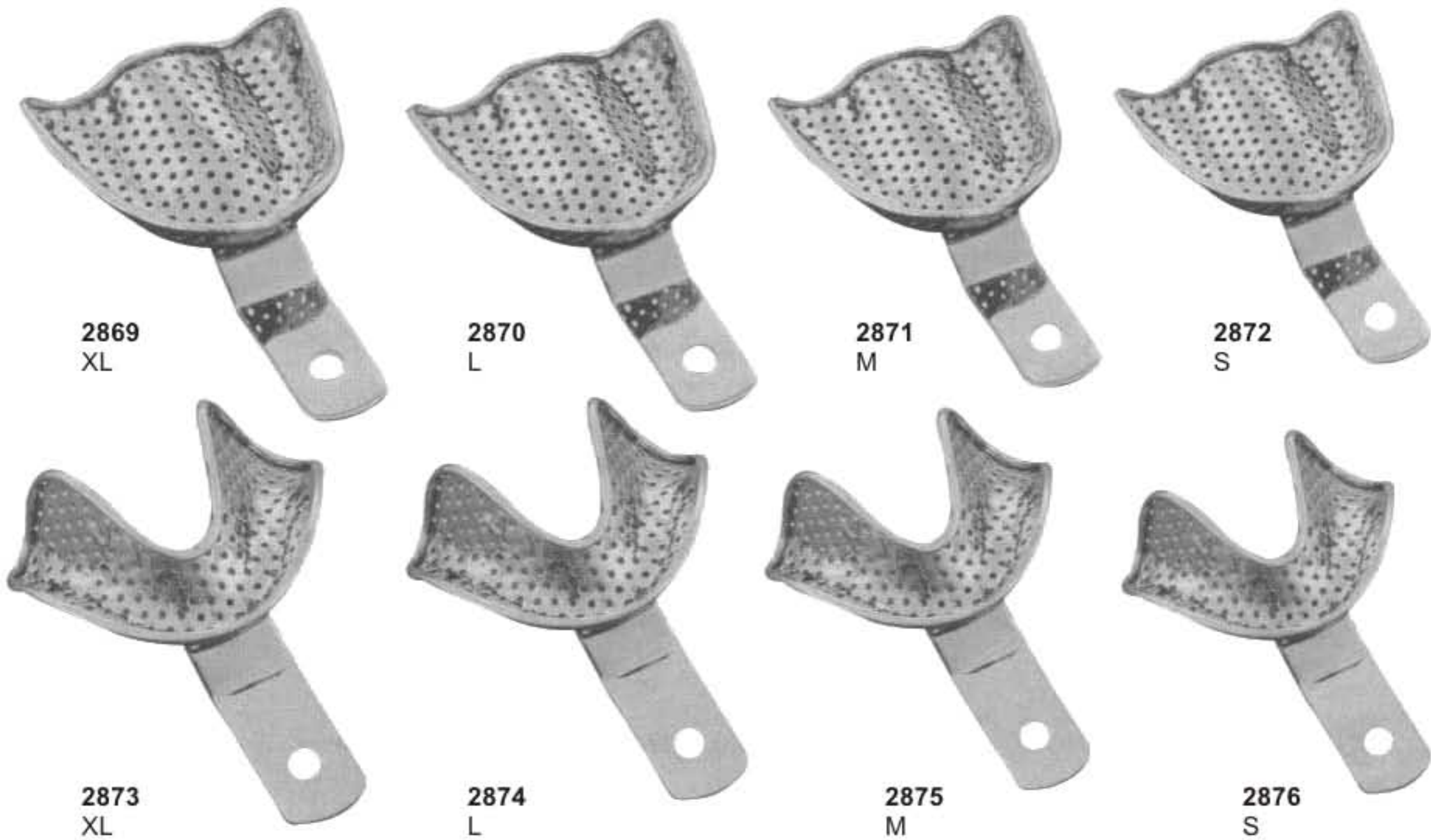

Perforated Full Denture Set of 8



Made of 18/8 Stainless Steel, Solid Set of 6



2877  
U1



2878  
U2



2879  
U3



2880  
L1



2881  
L2



2882  
L3

All The Above Impression Trays are Available in These 4 Sizes

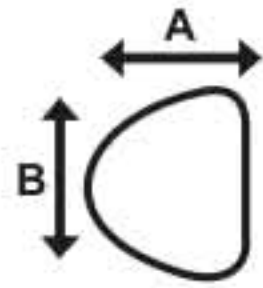

| UPPER |    | U1 | U2 | U3 |
|-------|----|----|----|----|
|       | A  | 67 | 64 | 57 |
| B     | 81 | 71 | 70 |    |

All Dimension are in mm

| LOWER |    | L1 | L2 | L3 |
|-------|----|----|----|----|
|       | A  | 60 | 57 | 54 |
| B     | 81 | 79 | 76 |    |

All Dimension are in mm

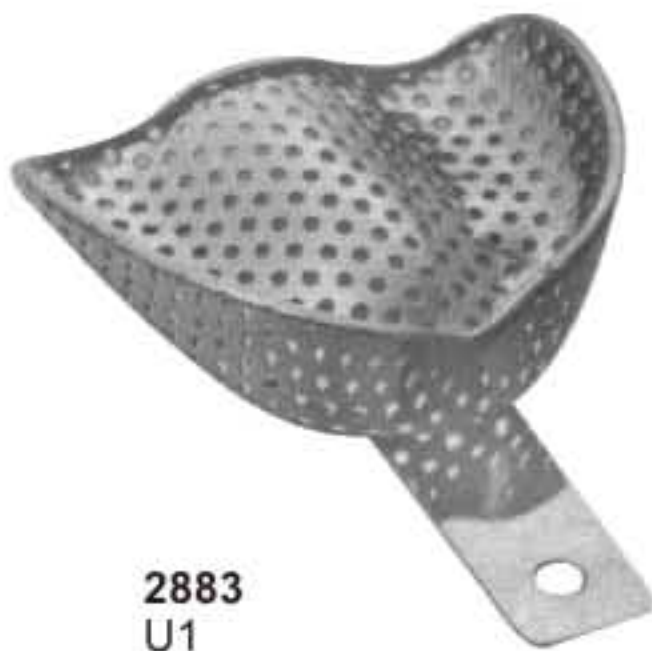
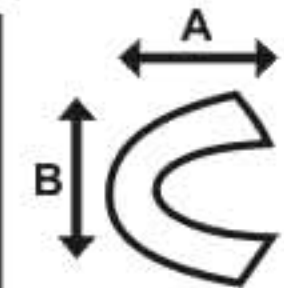

2883  
U1

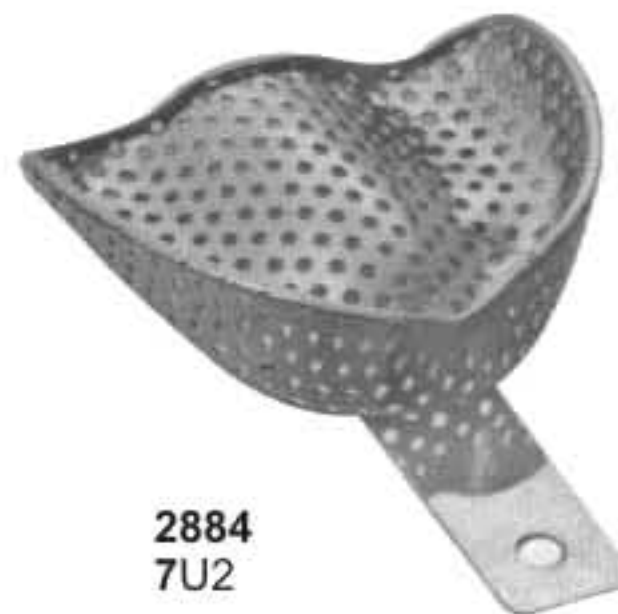

2884  
U2

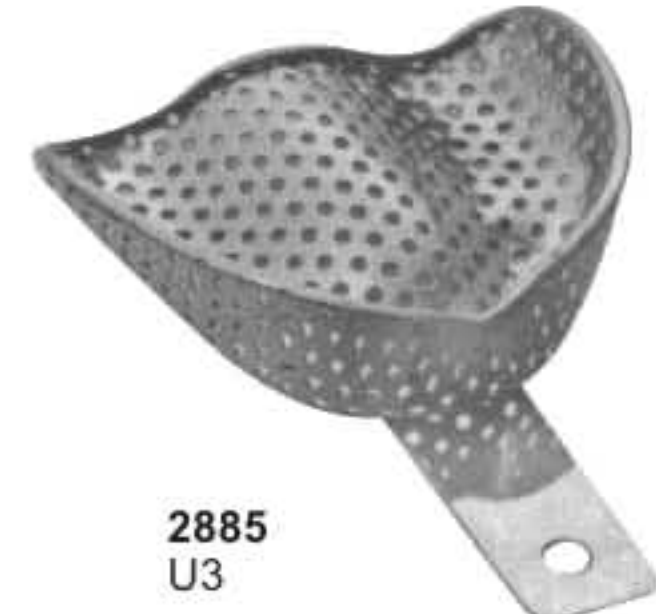

2885  
U3



2886  
L1



2887  
L2



2888  
L3

Perforated Set of 6

Made of 18/8 Stainless Steel, English Pattern Set of 8

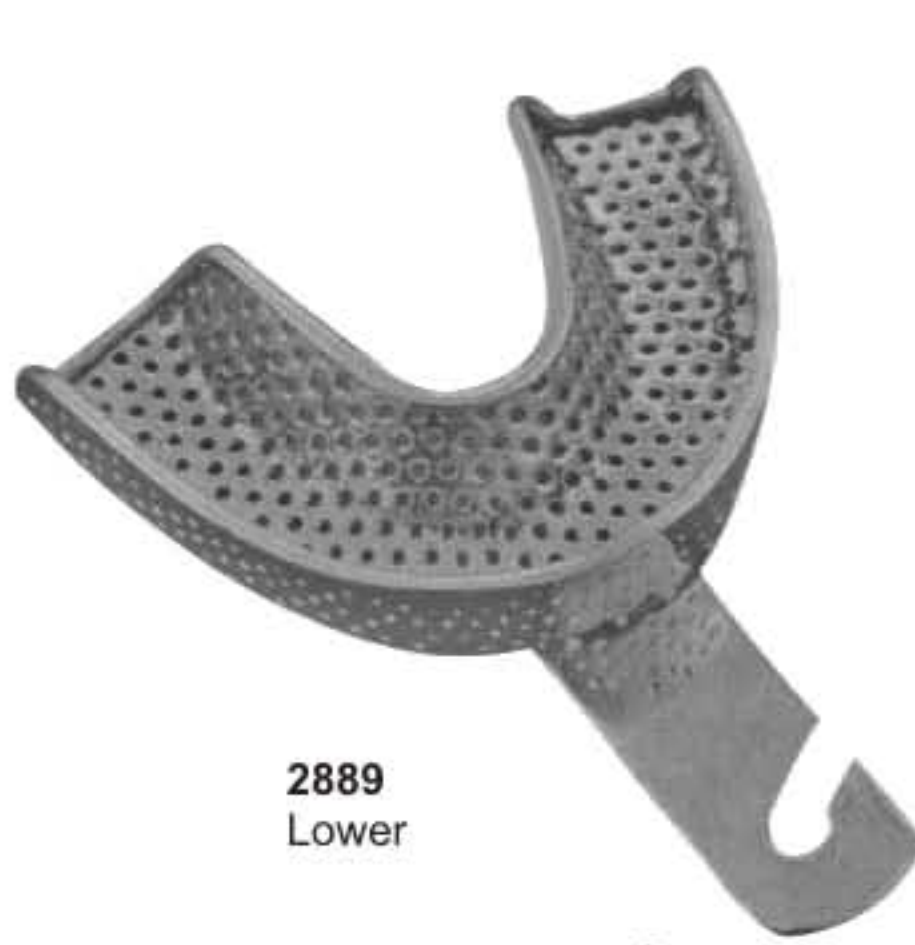

**2889**  
Lower



**2890**  
Upper



**2891**  
Lower



**2892**  
Upper



**2893**  
Lower



**2894**  
Upper

All The Above Impression Trays are Available in These 4 Sizes

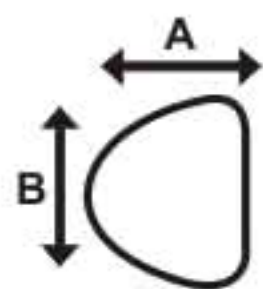

| <b>UPPER</b> | Size | A  | B  | C  |
|--------------|------|----|----|----|
|              | 0    | 67 | 50 | 12 |
|              | 1    | 72 | 51 | 13 |
|              | 2    | 78 | 55 | 15 |
|              | 3    | 80 | 58 | 15 |

All Dimension are in mm

| <b>LOWER</b> | Size | A  | B  | C  |
|--------------|------|----|----|----|
|              | 0    | 70 | 50 | 14 |
|              | 1    | 77 | 51 | 15 |
|              | 2    | 79 | 55 | 15 |
|              | 3    | 80 | 60 | 17 |

All Dimension are in mm

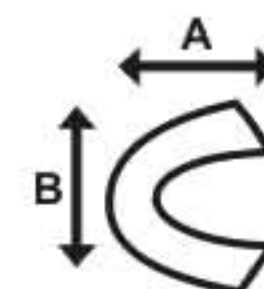

Made of 18/8 Stainless Steel, Solid Full Denture Set of 8

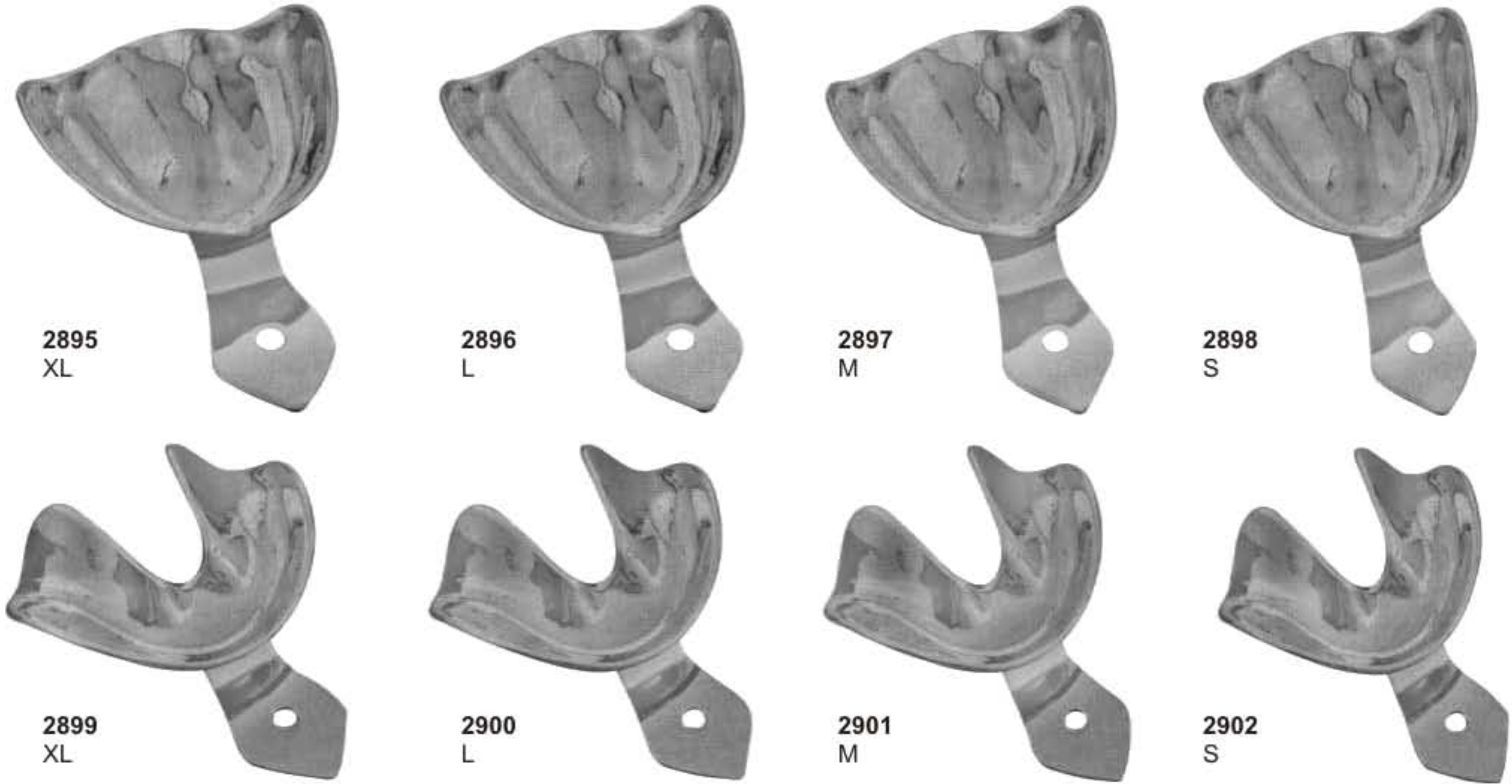

All The Above Impression Trays are Available in These 4 Sizes

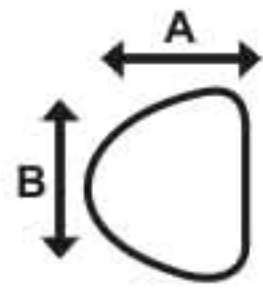

| UPPER | XL | L  | M  | S  |
|-------|----|----|----|----|
| A     | 70 | 67 | 64 | 60 |
| B     | 79 | 76 | 70 | 73 |

All Dimension are in mm

| LOWER | XL | L  | M  | S  |
|-------|----|----|----|----|
| A     | 64 | 64 | 60 | 57 |
| B     | 86 | 70 | 73 | 70 |

All Dimension are in mm

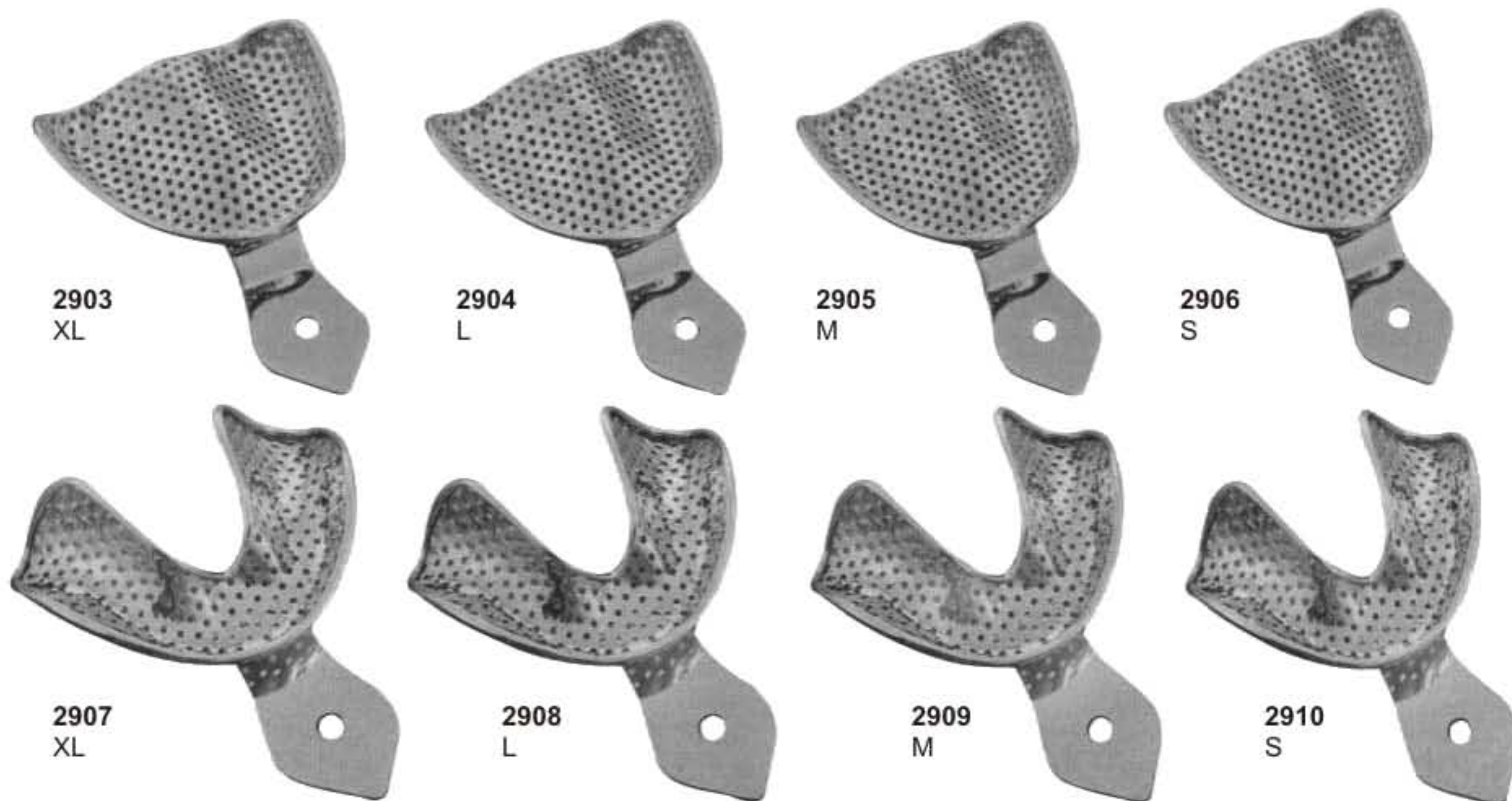

Made of 18/8 Stainless Steel, Perforated Full Denture Set of 8

Made of 18/8 Stainless Steel, Solid Full Denture Set of 8

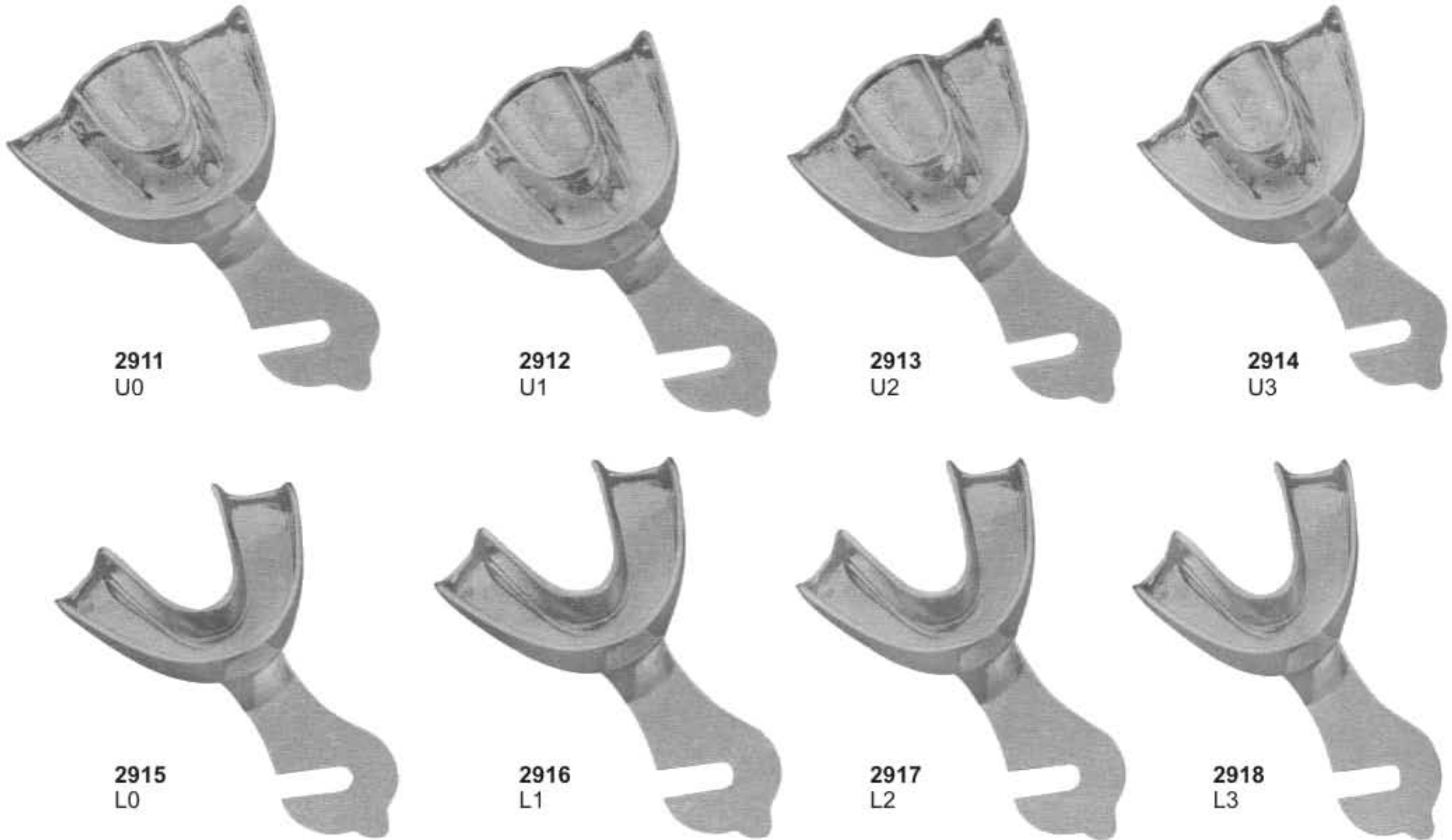

2911  
U0

2912  
U1

2913  
U2

2914  
U3

2915  
L0

2916  
L1

2917  
L2

2918  
L3

Upper Sizes: 0,1,2,3  
Depth of Tray: 15,9 mm, Height of Plate: 12,5 mm

Lower Sizes: 0,1,2,3  
Depth of Tray: 12,9 mm

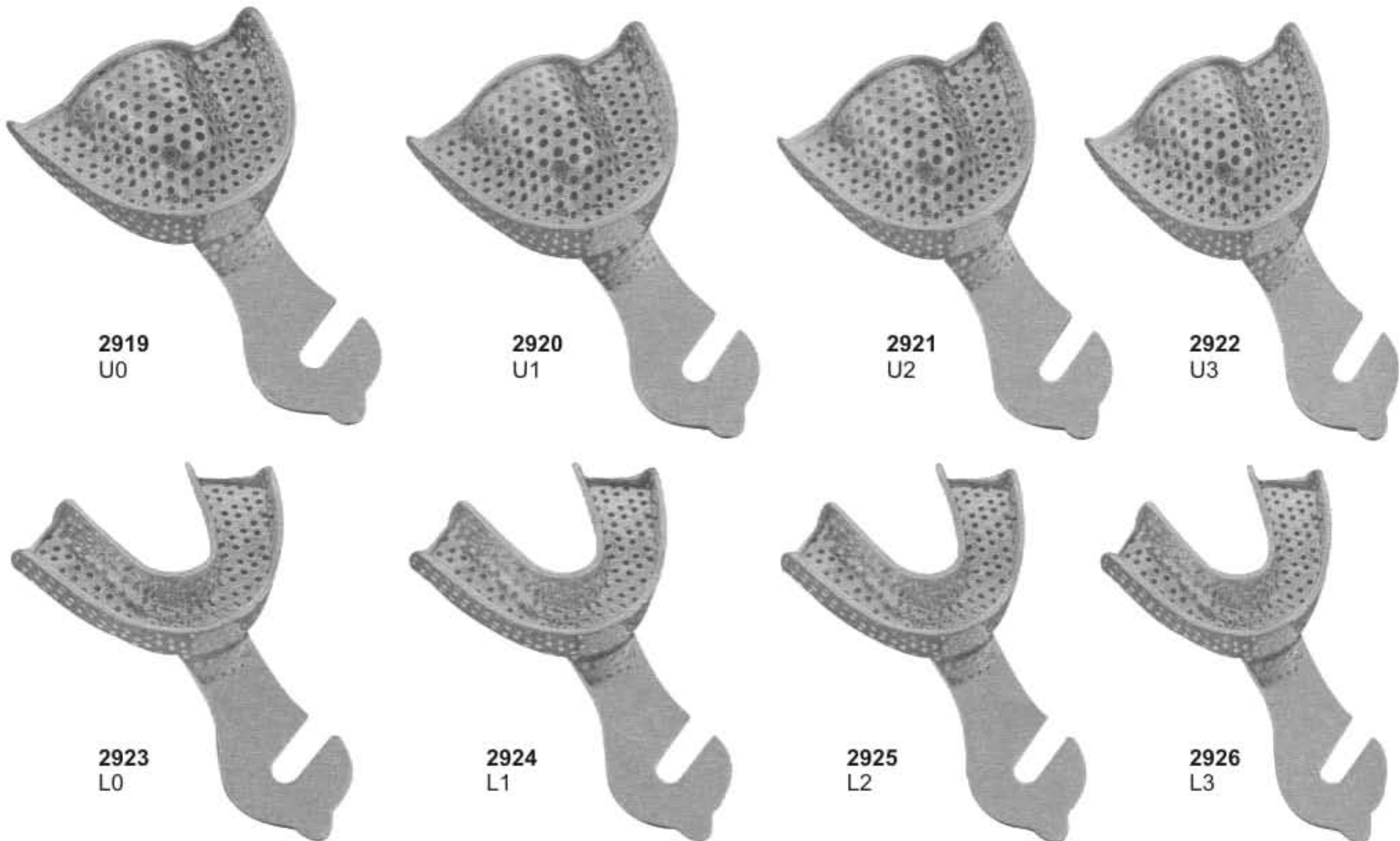

2919  
U0

2920  
U1

2921  
U2

2922  
U3

2923  
L0

2924  
L1

2925  
L2

2926  
L3

Made of 18/8 Stainless Steel, Perforated Full Denture Set of 8

Impression Trays For Crown & Bridge Work

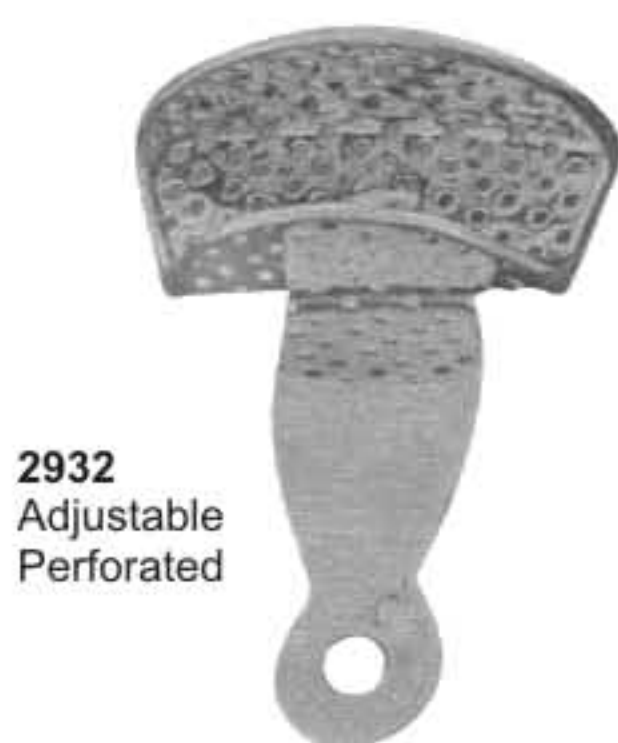
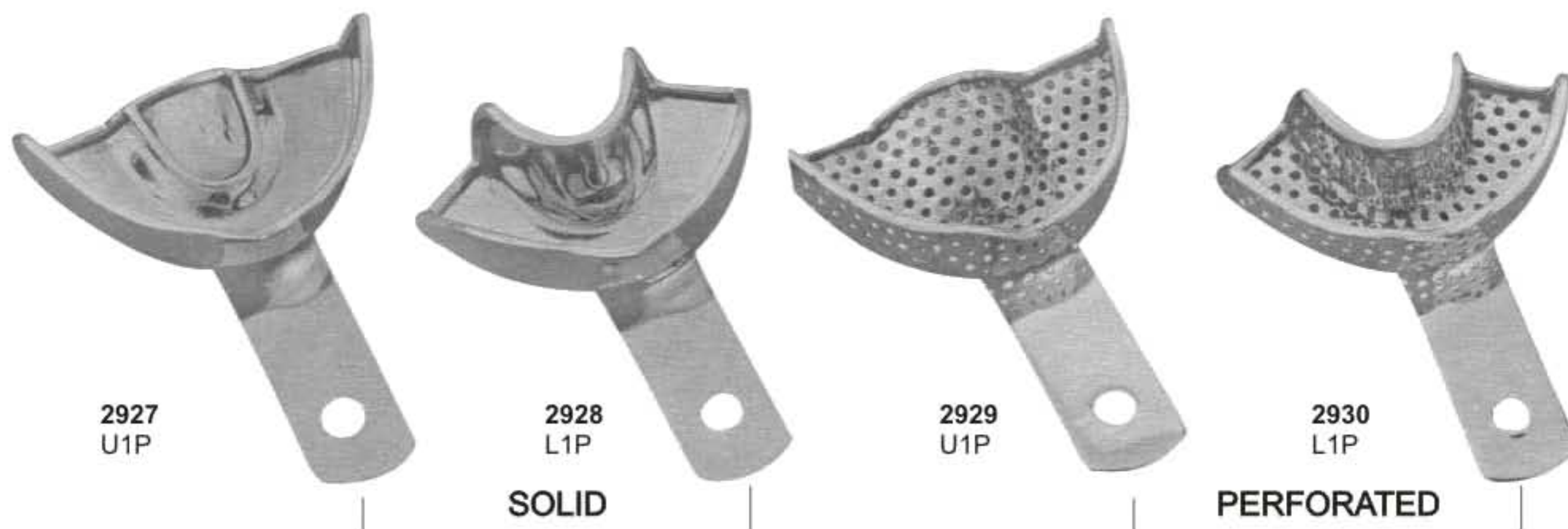

2932  
Adjustable  
Perforated



2933  
Adjustable  
Solid

PERFORATED

SOLID



2931-A  
For upper right jaw  
For lower left jaw

2931-B  
For upper left jaw  
For lower right jaw



2931-C  
For upper right jaw  
For lower left jaw

2931-D  
For upper left jaw  
For lower right jaw

Available in 4 sizes

- 1.....44 mm
- 2.....55 mm
- 3.....60 mm
- 4.....65 mm

Available in 4 sizes

- 1.....44 mm
- 2.....55 mm
- 3.....60 mm
- 4.....65 mm



2934



2935



2936



2937



2939



2938



2940



2941



2942



2943



2944



2945



2946



2947



**2948**  
Instruments Tray of 20 Pcs

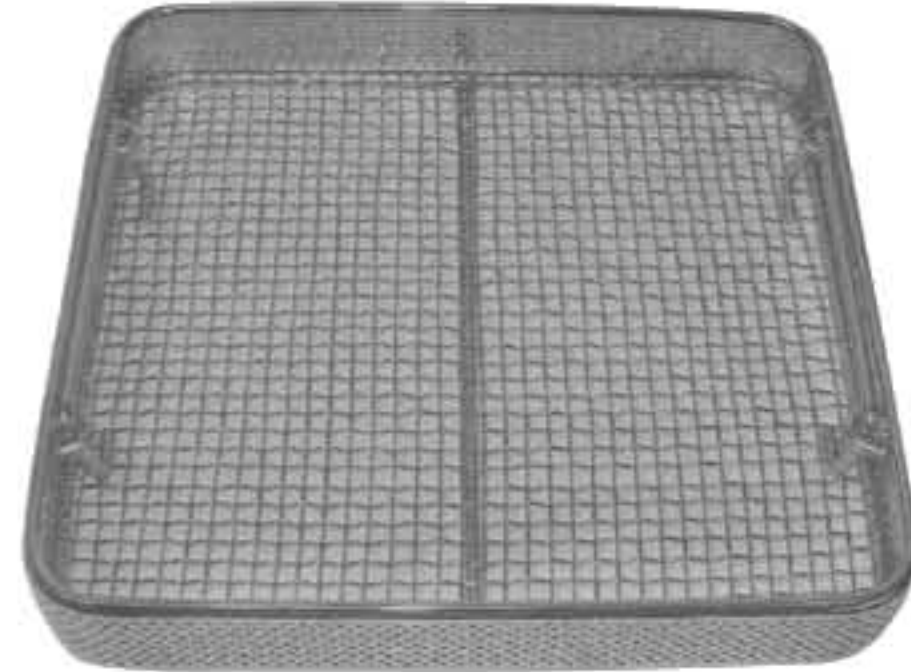

**2951**  
Instruments Riddle



**2949**  
Instruments Tray of 7 Pcs



**2949-A**  
Instruments Tray of 10 Pcs



**2950**  
Instruments Tray of 5 Pcs

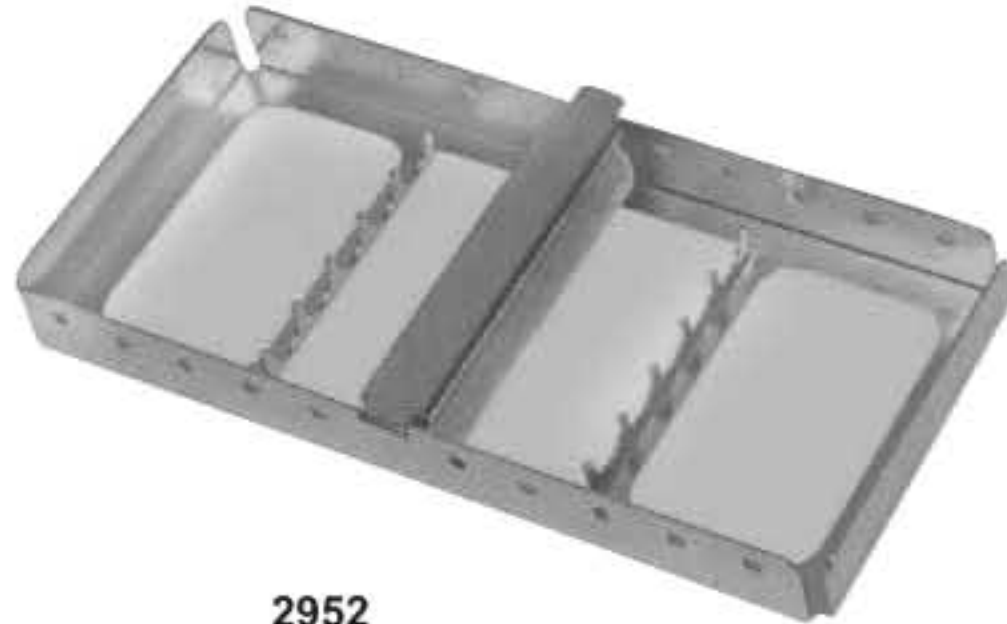

**2952**  
Instruments Tray of 5 Pcs

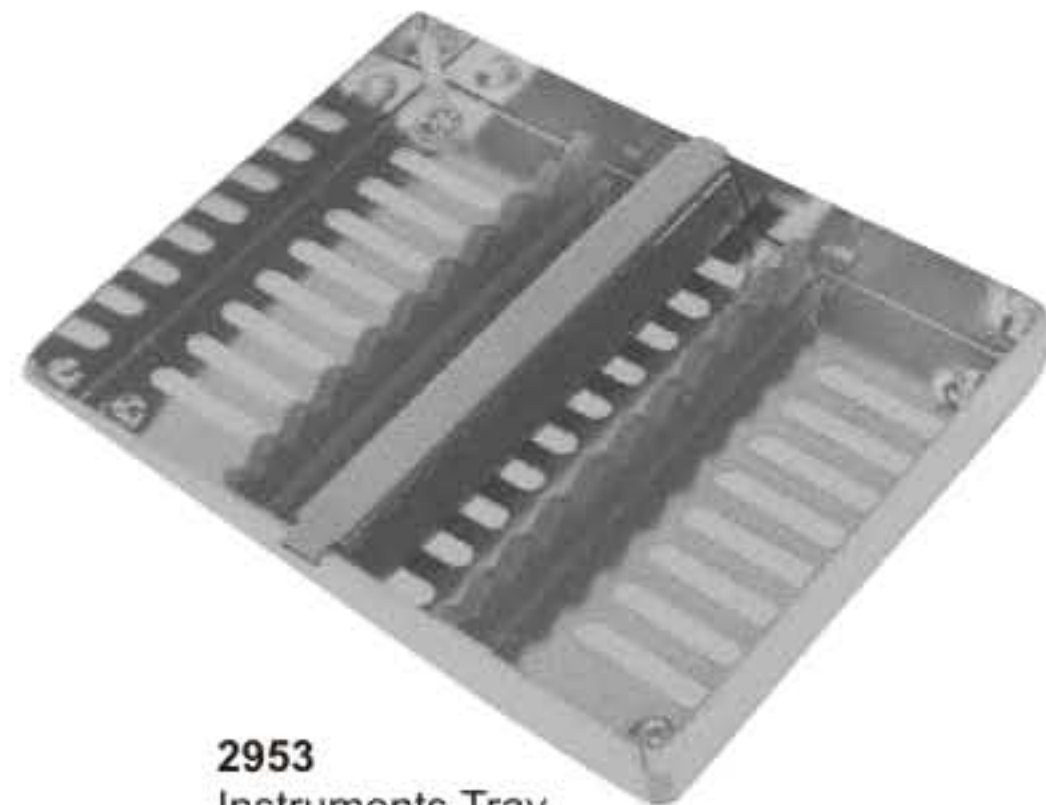

**2953**  
Instruments Tray



**2954**  
Instruments Tray  
Perforated



**2955**  
Instruments Tray  
Perforated Base



**2956**  
Instruments Tray  
Solid Base





**2957**  
Pulpectomy Tray



**2958**  
Sterilizing Box  
Available Sizes:  
17x17x3 cm  
20x10x6 cm  
30x14x6 cm



**2959**  
Endo Tray Box



**2960**  
Finger Cup



**2961**  
Bur Box

**2962**  
Sterilizing Drum  
150x150mm  
175x175mm  
190x190mm  
200x140mm  
200x200mm  
240x120mm  
225x225mm  
240x240mm  
290x160mm



**2963**  
Sterilizing Drum  
280x240mm  
230x150mm  
300x250mm  
340x160mm  
350x250mm  
390x200mm  
380x300mm  
100x100mm  
150x120mm



**2964**  
Instruments Box



**2965**  
Instruments Box



**2966**  
Instruments Box



**2967**  
Instruments Sterilizer  
150x75 mm



**2968**  
Endodontic Box



**2969**  
Sterilizing Box  
320x120 mm



**2970**  
Instruments Tray



**2971**  
Instruments Tray



**2972**  
Instruments Tray  
(Perforated)



**2973**  
Instruments Tray  
Shallow(Mayo)



**2974**  
Scaler Tray  
20.0 x 10.0 x 1.5 cm



**2975**  
Scalers Tray



**2976**  
Scalers Tray



2982  
Spitten Mug



2983  
Spirit Burner With Wick  
Stainless Steel 18/10  
Capacity: 150 ml, 60 ml



2984  
Spirit Burners With Wick  
Stainless Steel 18/10  
Capacity: 70ml



2985  
Dressing Jar



2986  
Dressing Jar



2987  
Irrigator (Douch Can)



2988  
Measuring Jug



**2989**  
Sponge Bowl



**2990**  
Wash Basin  
300mm-350mm-400mm



**2994**  
Kick Bucket With Trolley



**2991**  
Sponge Bowl



**2992**  
Gallipot



**2993**  
Medicine Cup



**2995**  
Kidney Tray Shallow  
150mm-200mm-240mm-300mm



**2996**  
Kidney Tray Without Lid  
150mm-200mm-250mm-300mm



**2997**  
Kidney Tray With Lid  
150mm-200mm-250mm-300mm

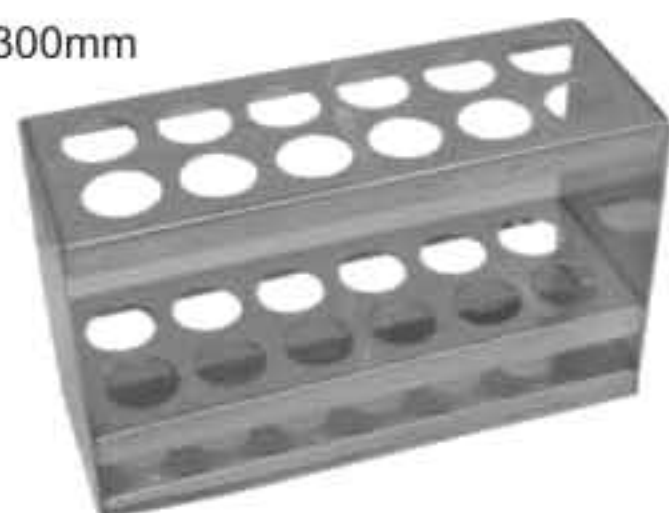

**2998**  
Tube Rack, Stainless Steel 18/10



**2999**  
Needle Case Rectangle  
Needle Case Round With Cover  
90x15



**3000**  
Dustbin Without Stand  
6-10-12 Ltr



**3001**  
Tube Rack, Round Model  
Stainless Steel 18/10



**3002**  
Dustbin Without Stand & Cap  
6-10-12 Ltr

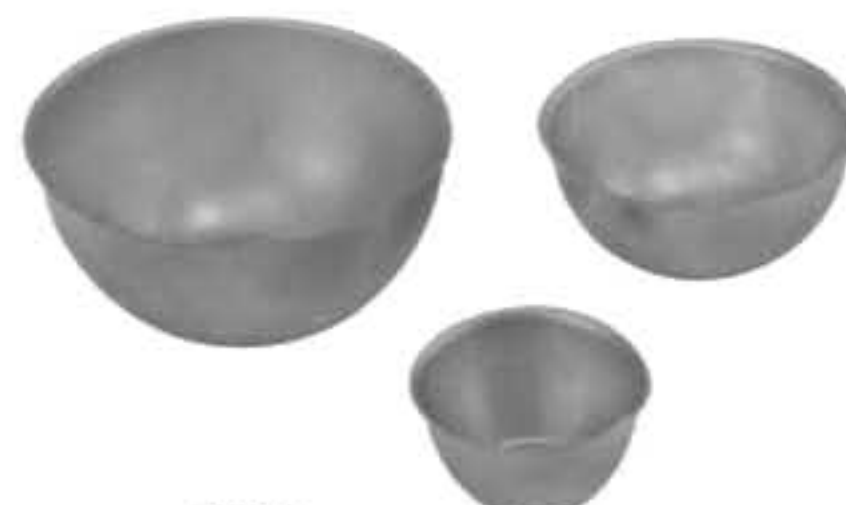

**3003**  
Lotion Bowl With Lip  
40-60-80-100-120-150-180-200mm

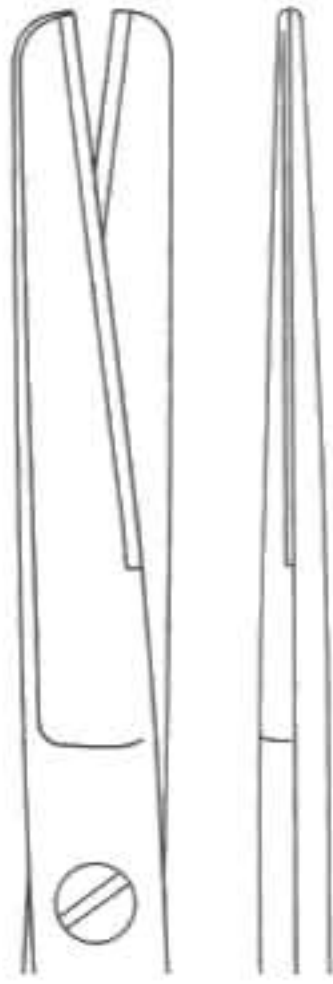

**3004**  
Standard

14,5cm  
16,5cm  
18,5cm



**3005**  
Standard

14,5cm  
16,5cm  
18,5cm

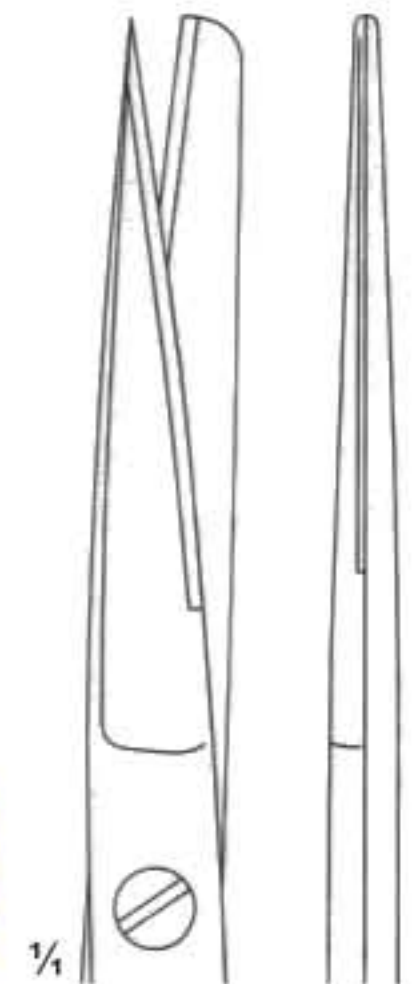

**3006**  
Standard

14,5cm  
16,5cm  
18,5cm

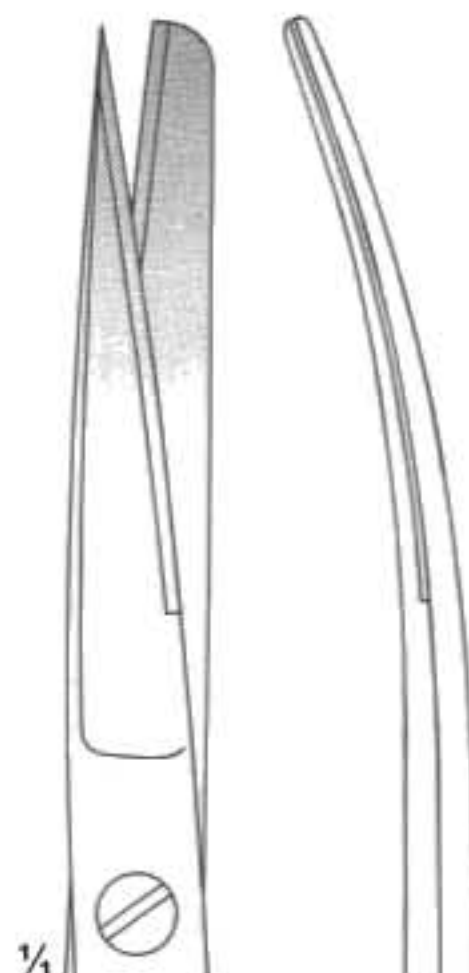

**3007**  
Standard

14,5cm  
16,5cm  
18,5cm

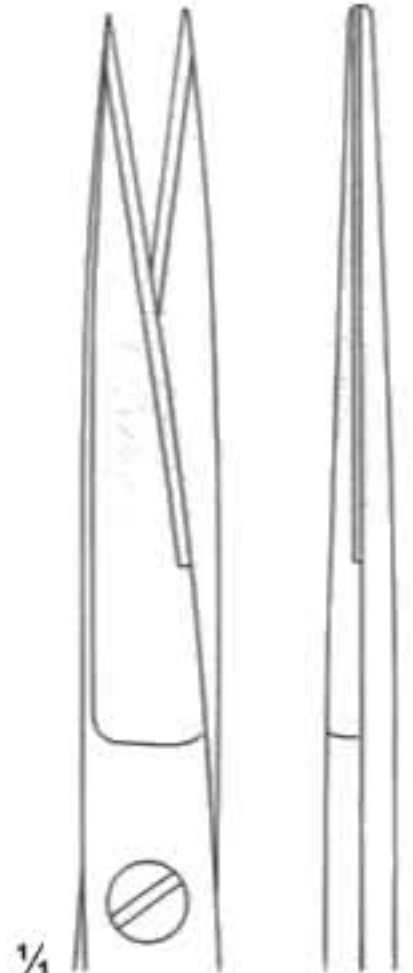

**3008**  
Standard

14,5cm  
16,5cm  
18,5cm

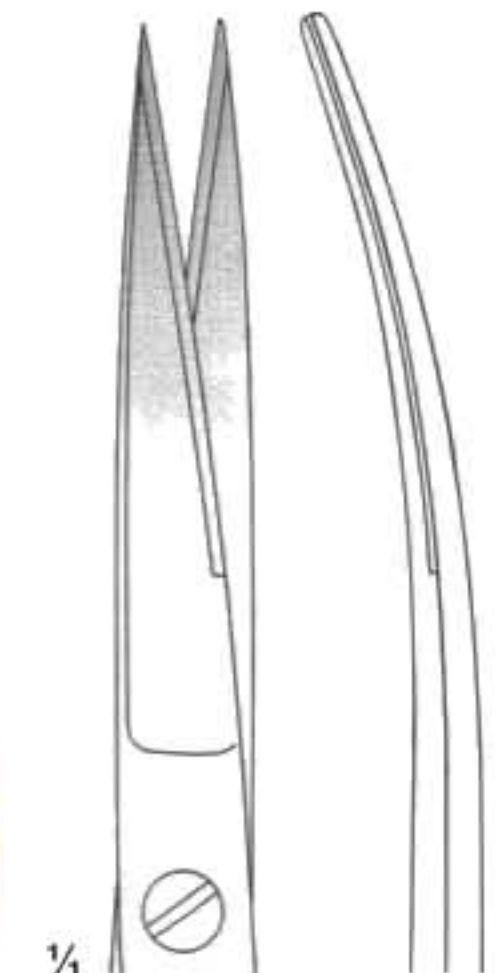

**3009**  
Standard

14,5cm  
16,5cm  
18,5cm

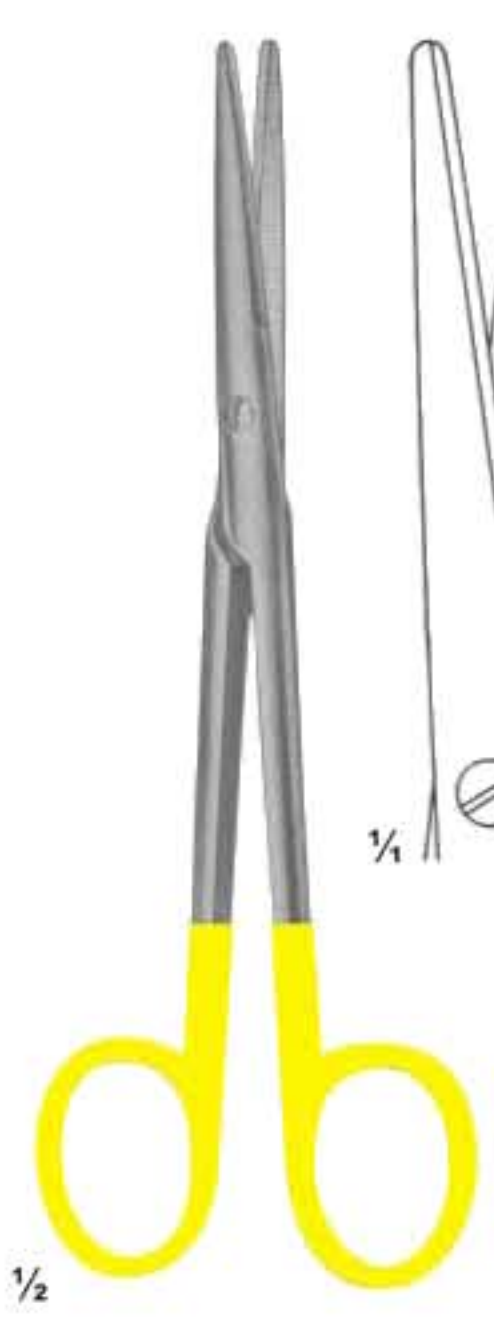

**3010**  
MAYO-LEXER  
Straight  
16 cm

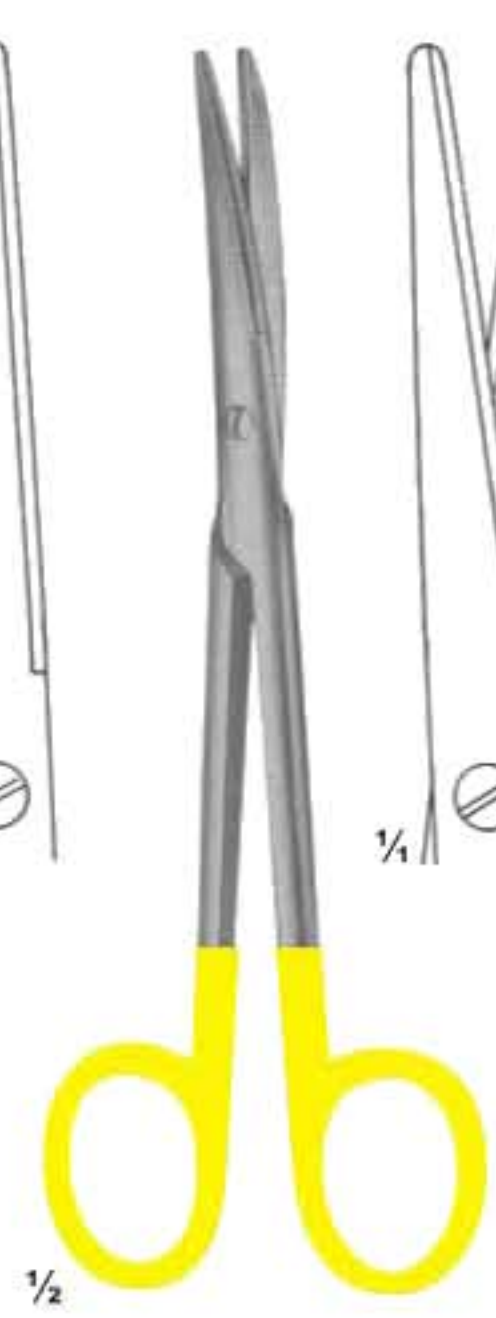

**3011**  
MAYO-LEXER  
Curved  
16 cm

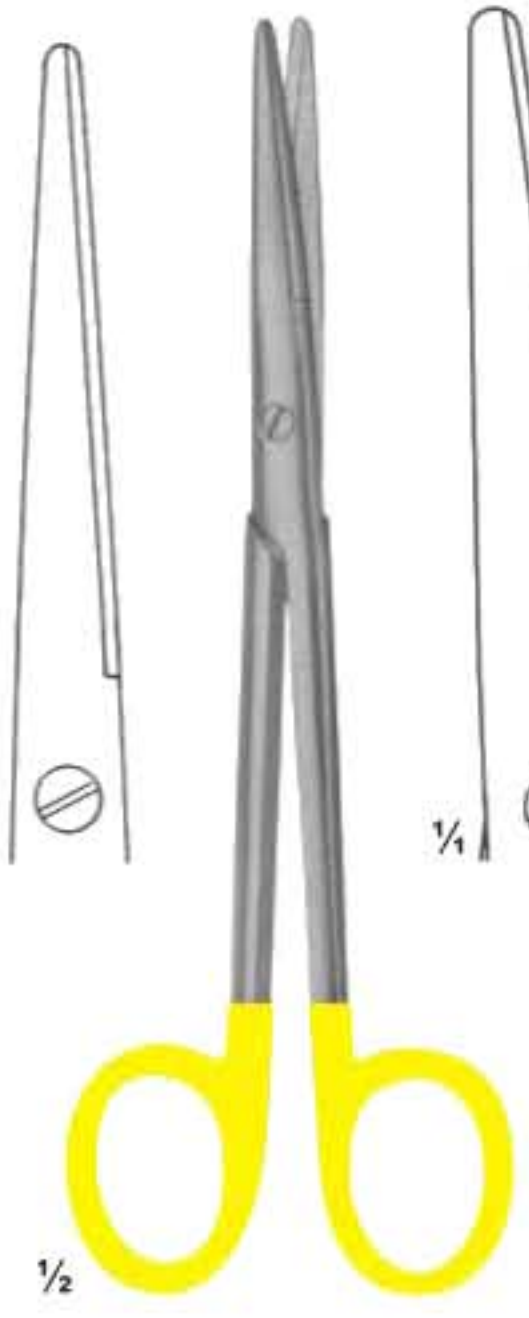

**3012**  
LEXER  
Straight  
16, 21 cm

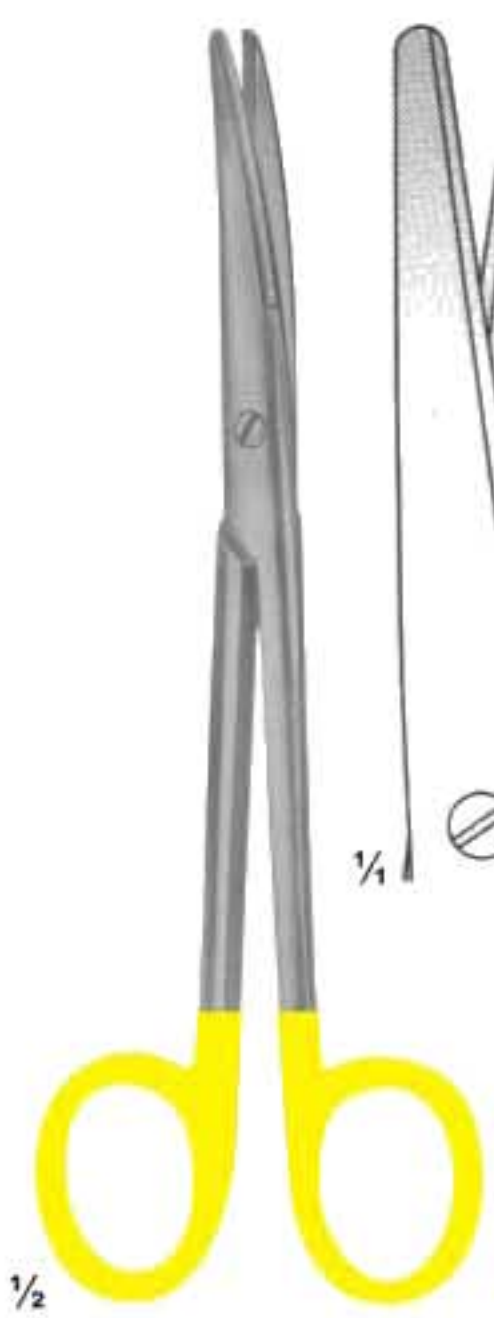

**3013**  
LEXER  
Curved  
16, 21 cm

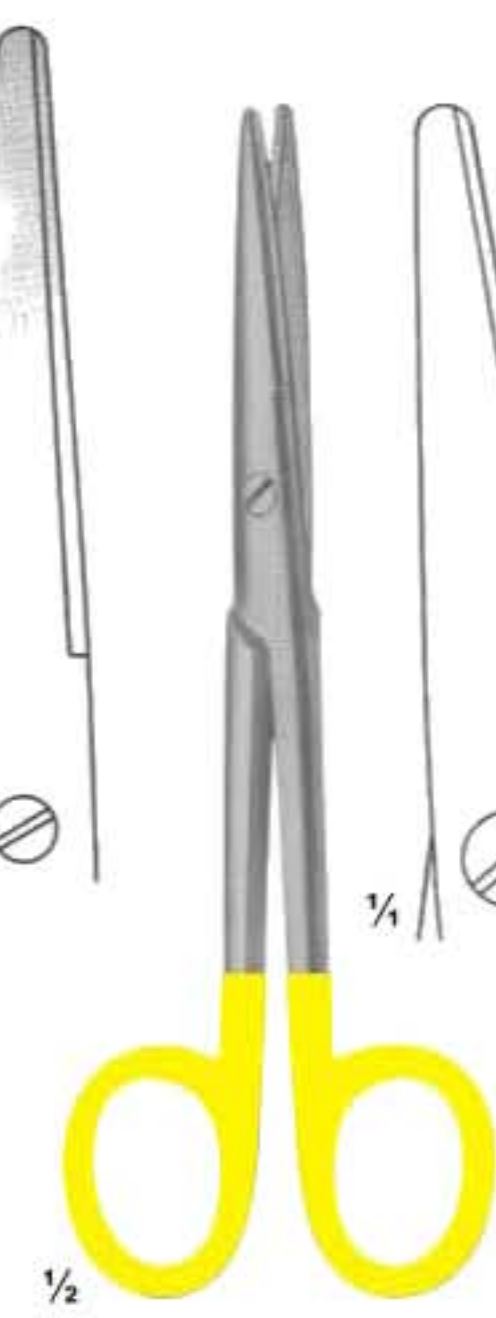

**3014**  
MAYO-STILLE  
Straight  
15, 17 cm

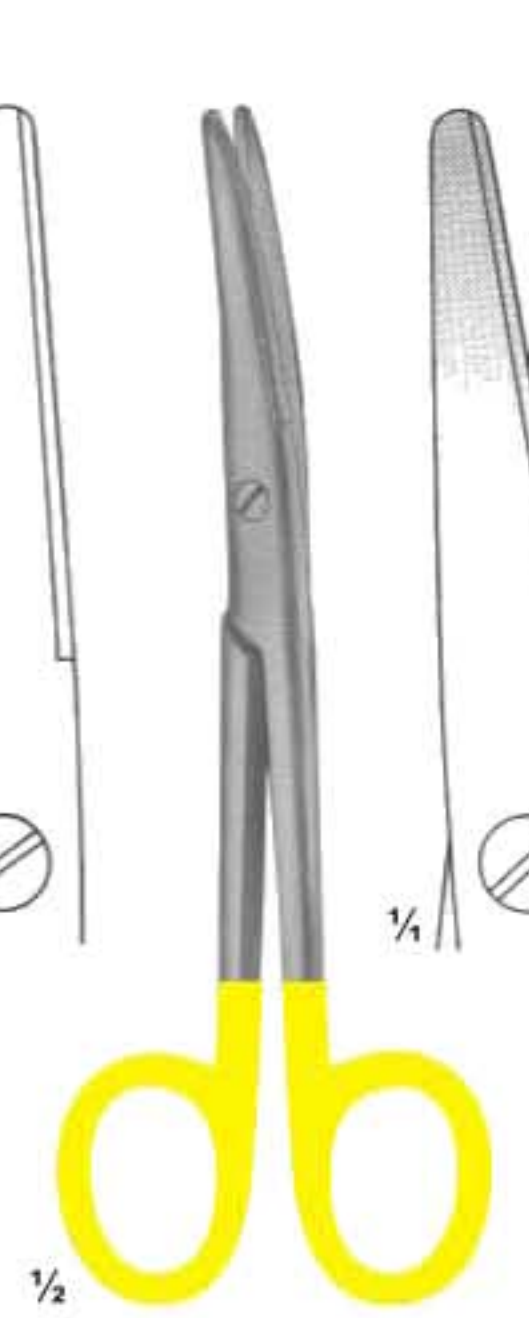

**3015**  
MAYO-STILLE  
Curved  
15, 17 cm

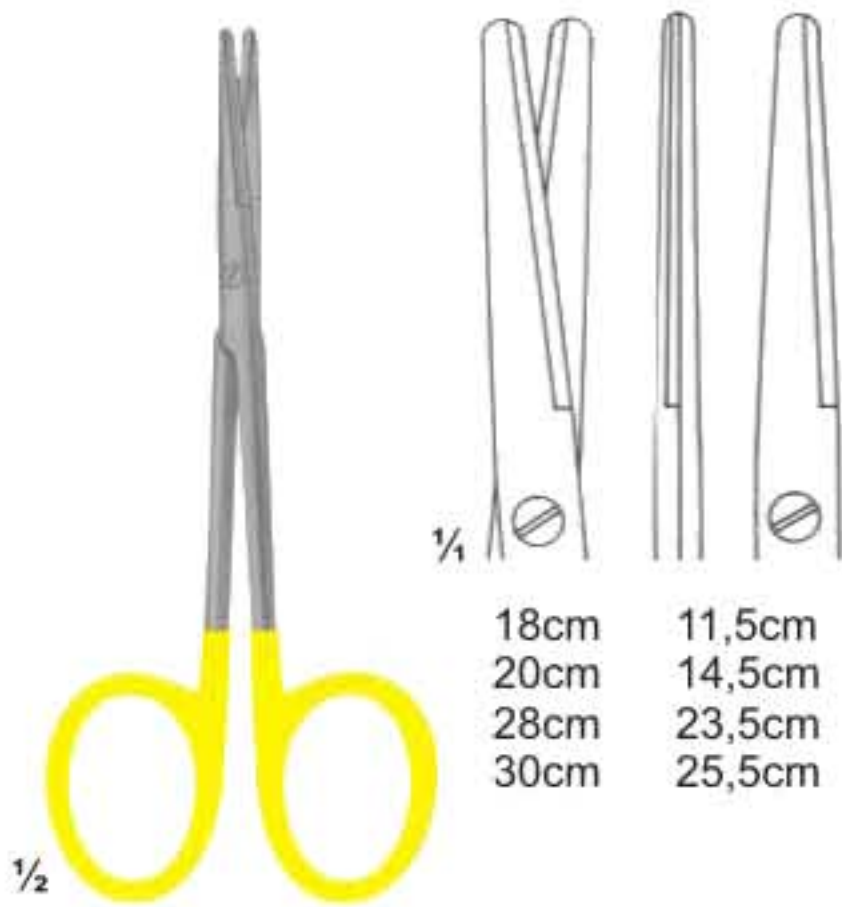

**3016**  
METZENBAUM  
Straight

18cm  
20cm  
28cm  
30cm

11,5cm  
14,5cm  
23,5cm  
25,5cm

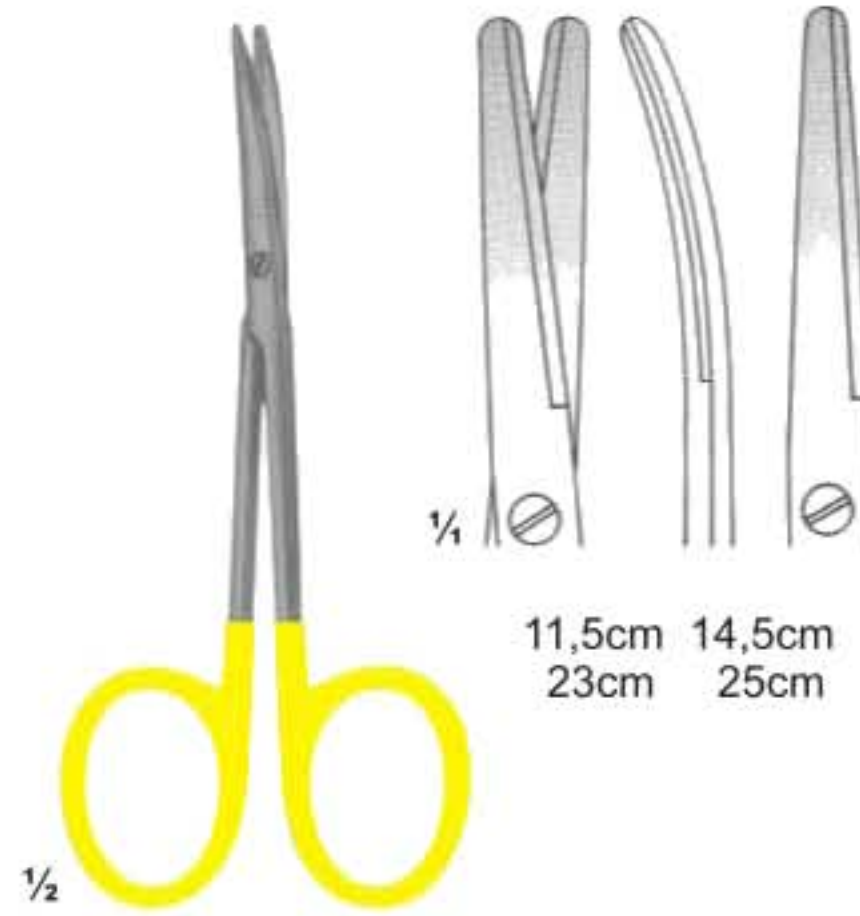

**3017**  
METZENBAUM  
Curved

11,5cm  
23cm

14,5cm  
25cm

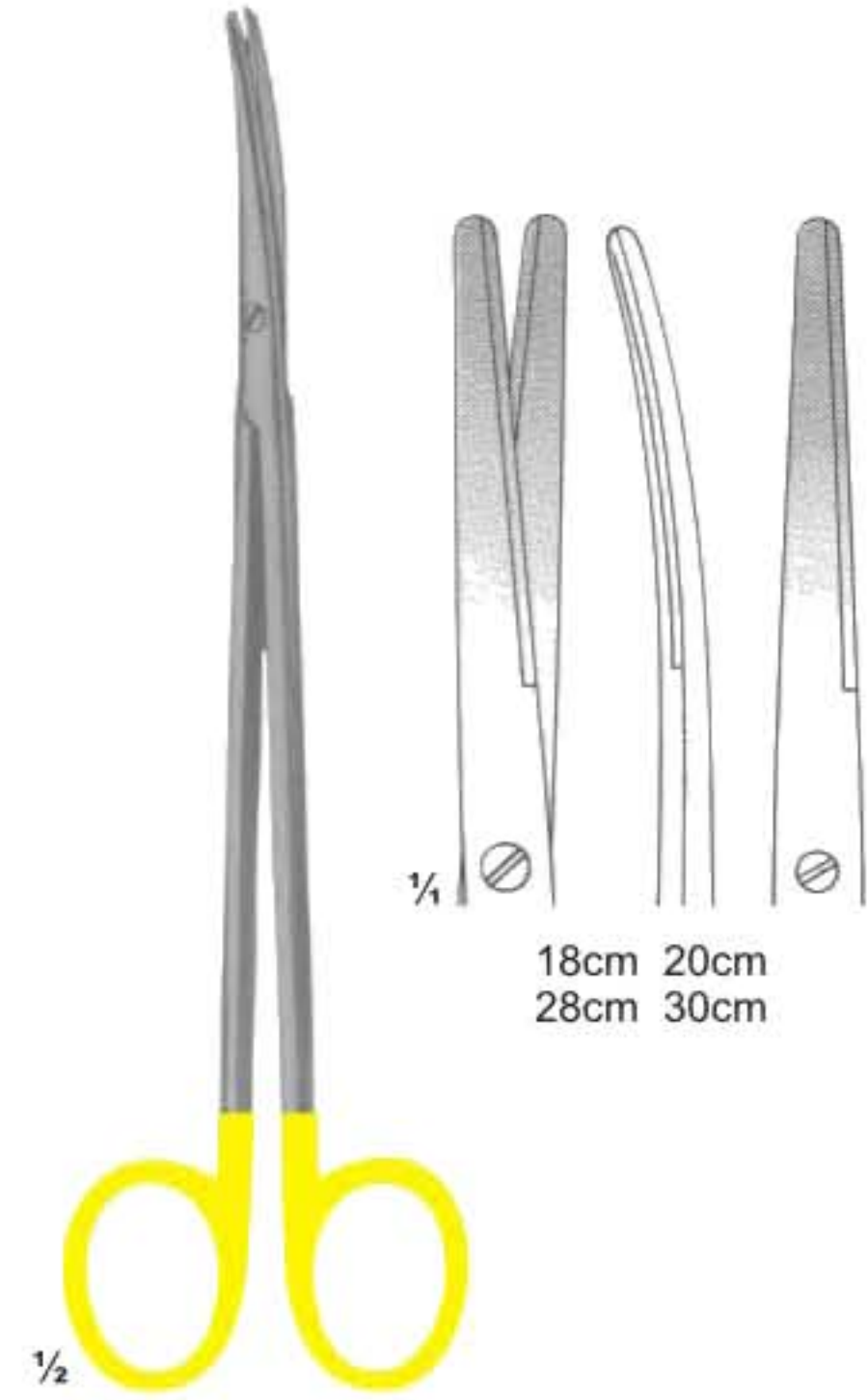

**3018**  
METZENBAUM  
Curved

18cm  
20cm  
28cm  
30cm



**3019**  
METZENBAUM FINO  
Straight

14cm  
23cm

18cm  
25cm

20cm  
28cm



**3020**  
METZENBAUM FINO  
Curved

14cm  
23cm

18cm  
25cm

20cm  
28cm

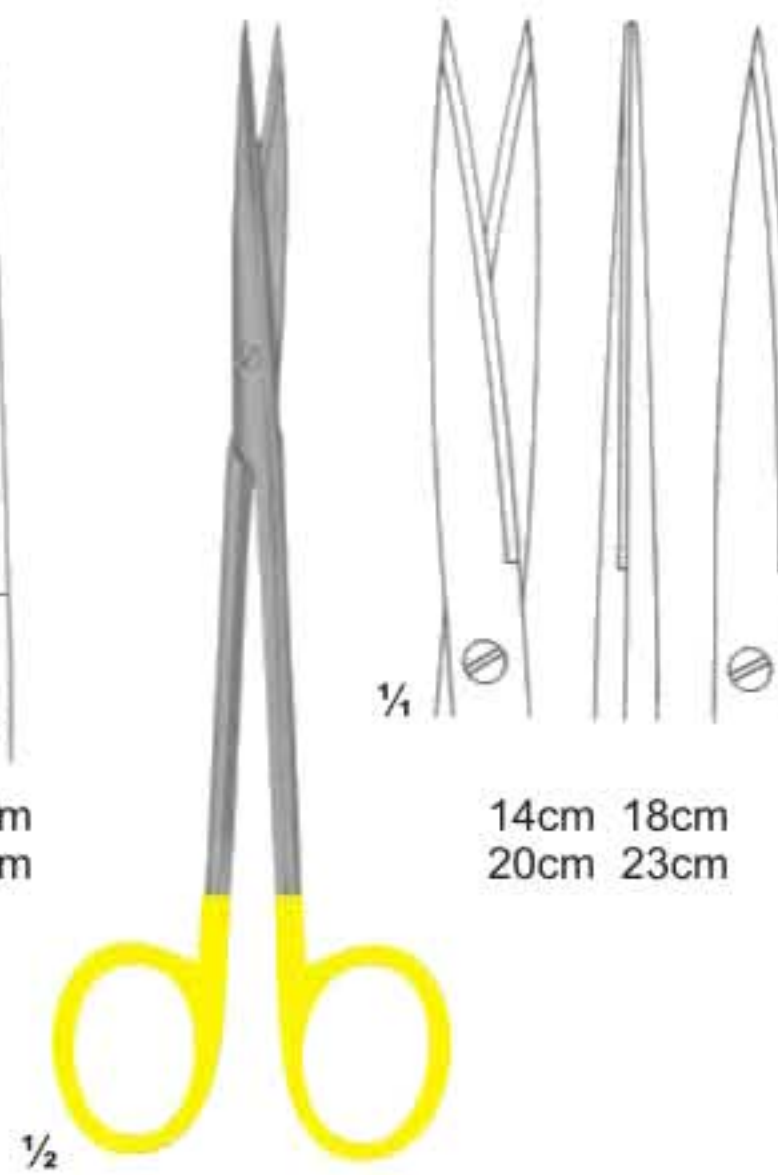

**3021**  
METZENBAUM FINO  
Sharp

14cm  
20cm

18cm  
23cm

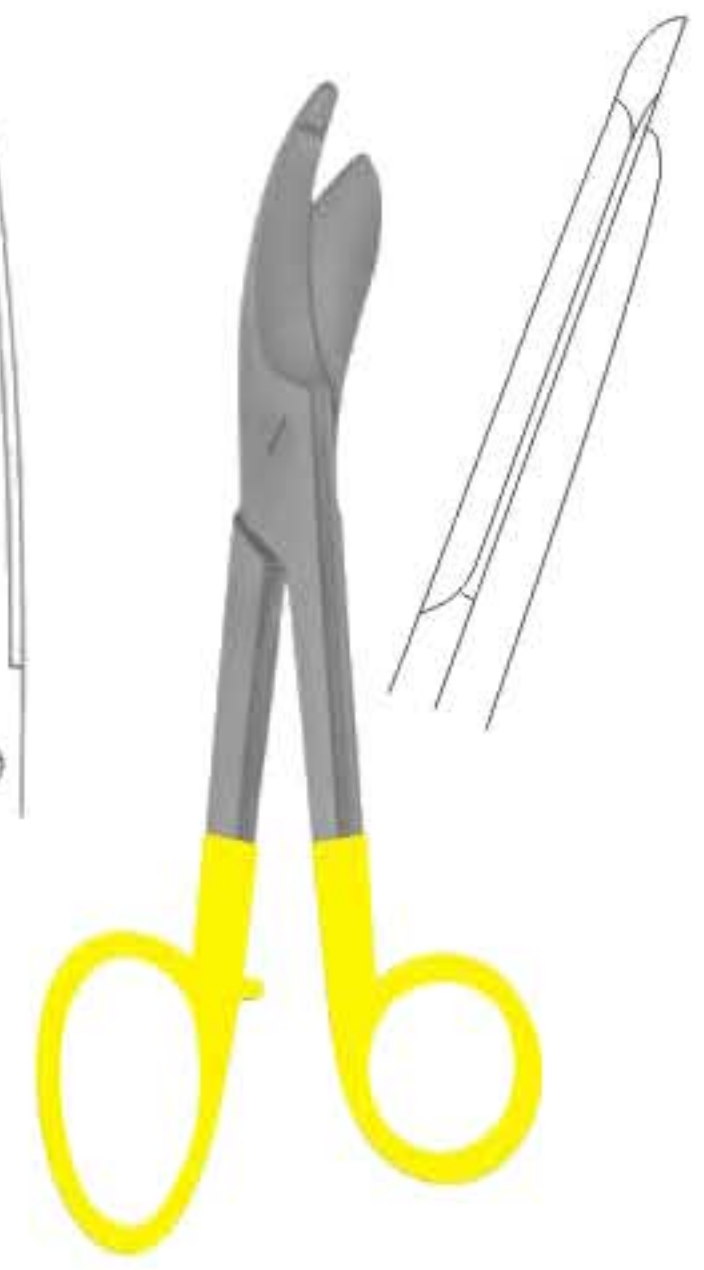

**3022**  
BRUNS  
235 mm

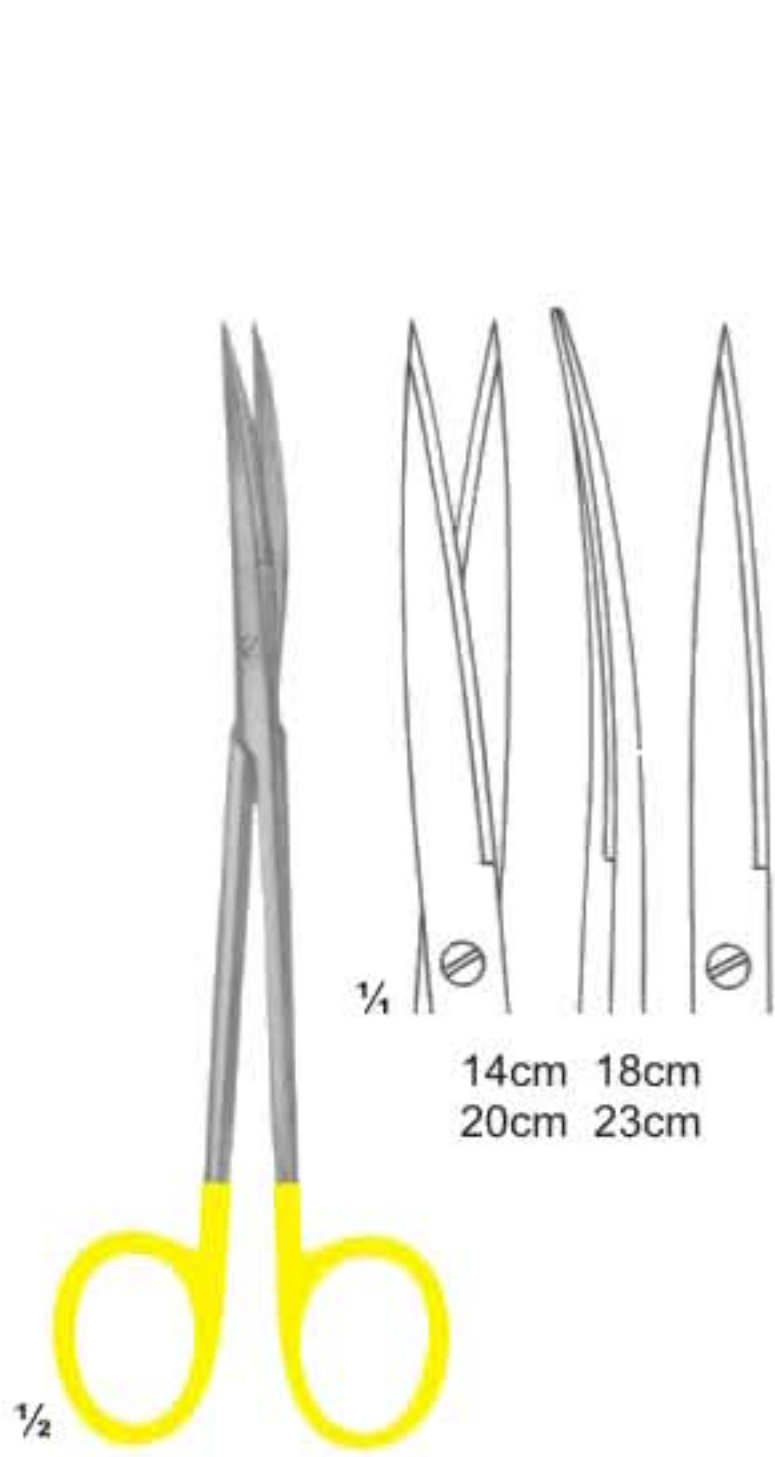

**3023**  
METZENBAUM FINO

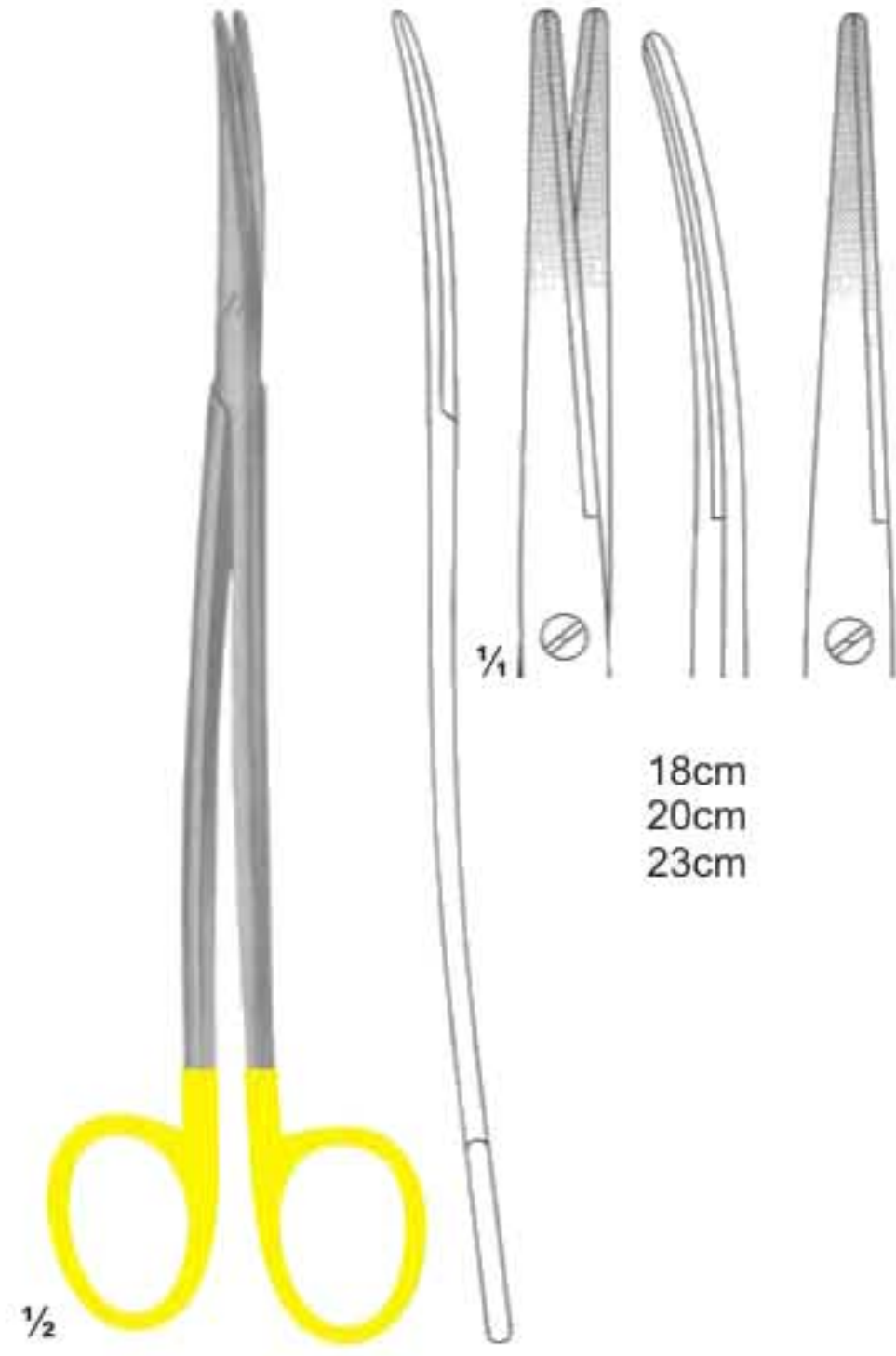

**3024**  
METZENBAUM FINO

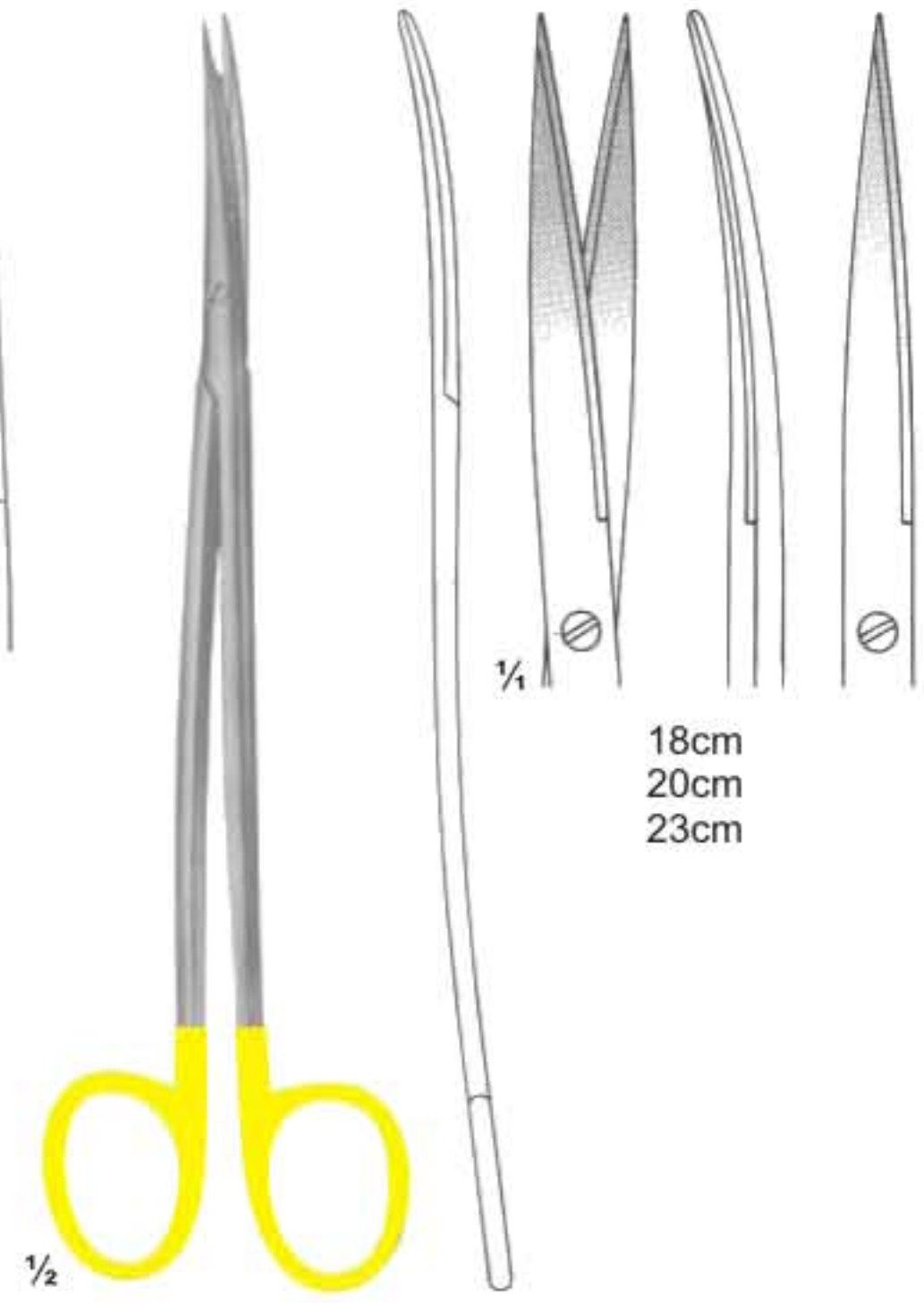

**3025**  
METZENBAUM FINO

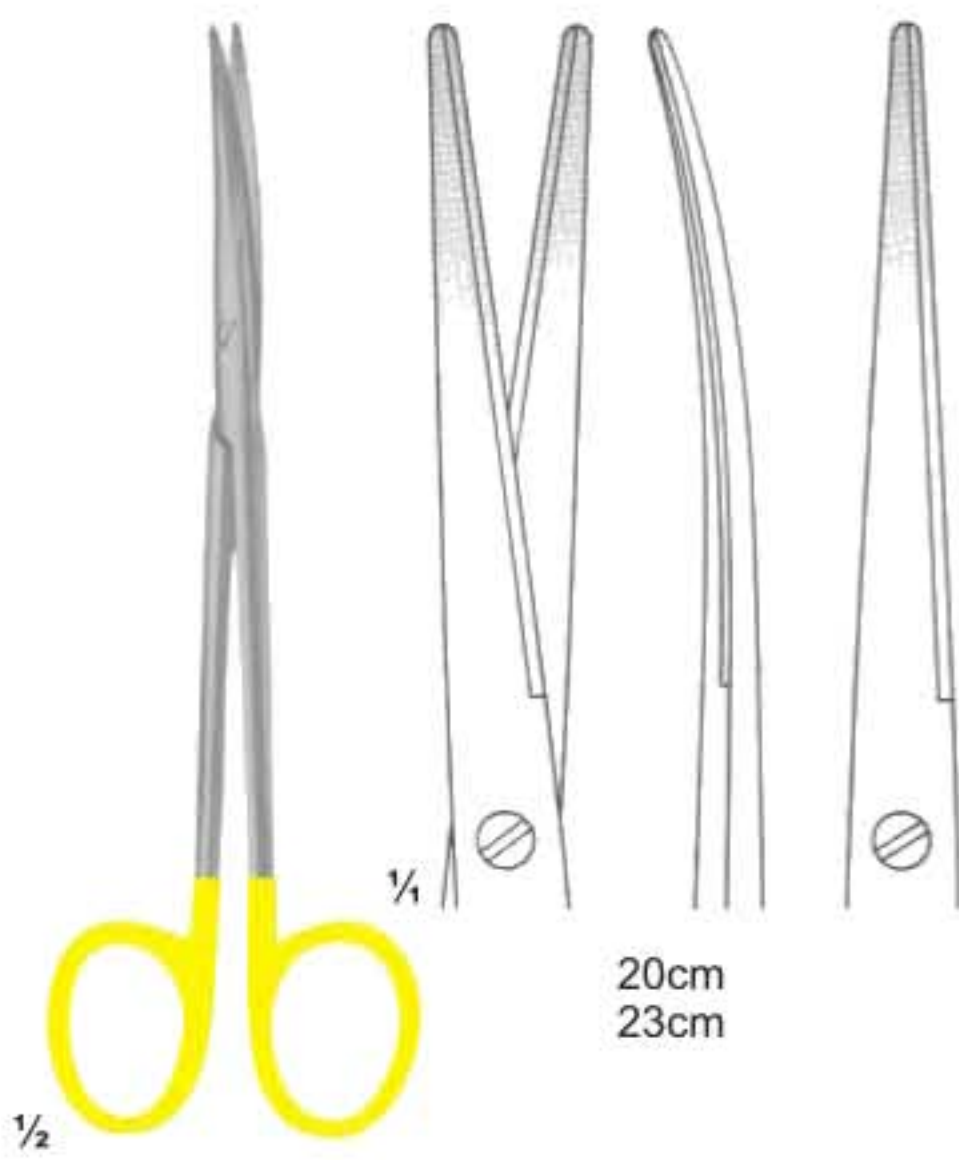

**3026**  
METZENBAUM FINO

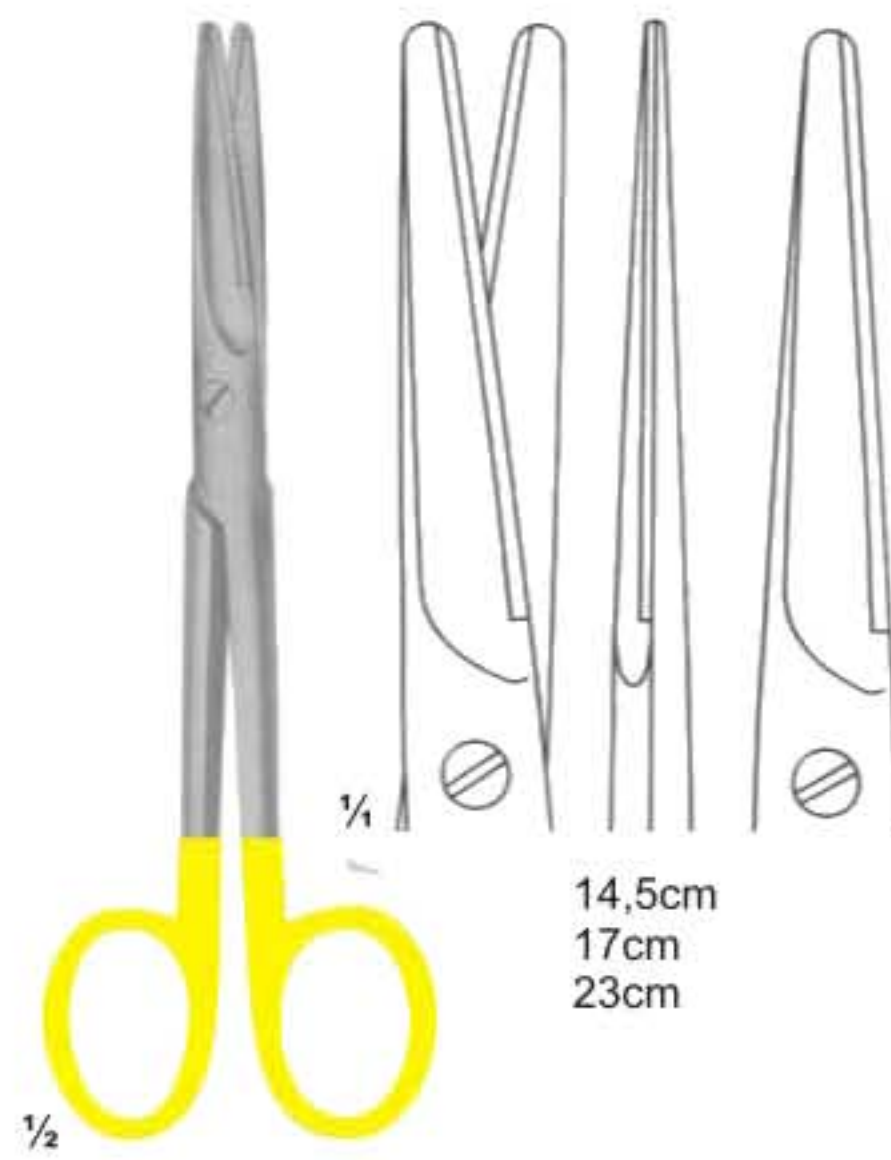

**3027**  
MAYO  
Straight

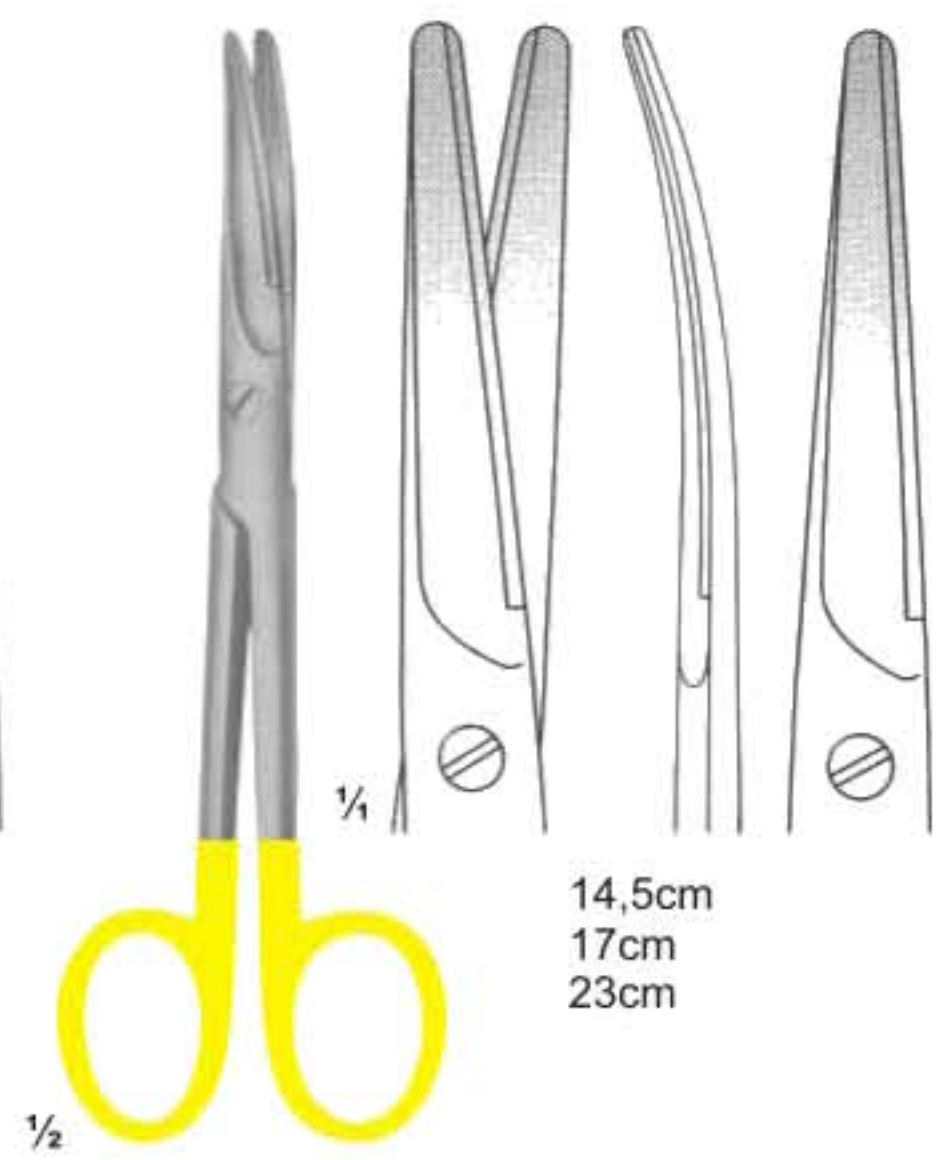

**3028**  
MAYO  
Curved



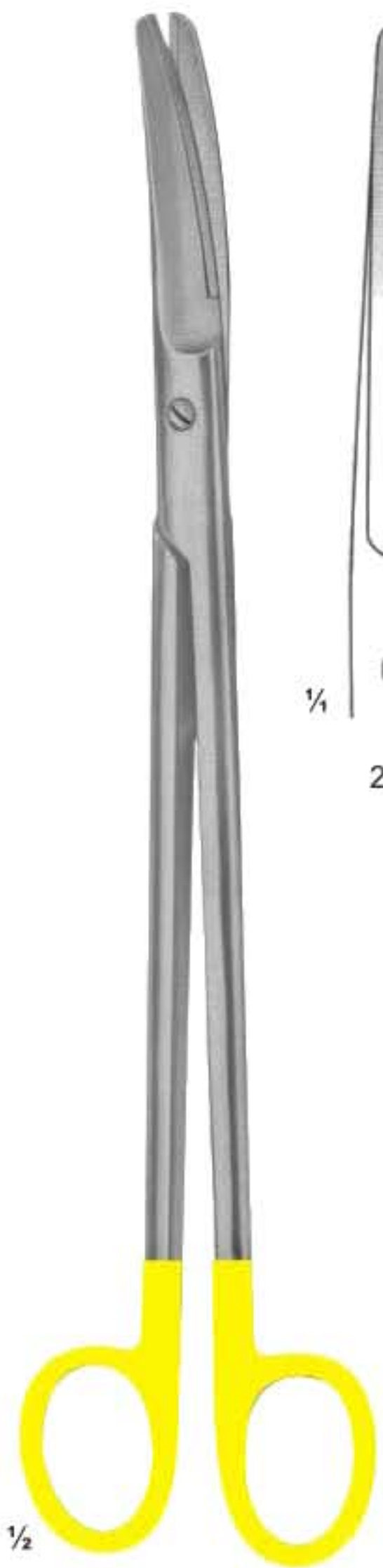

**3029**  
SIMS

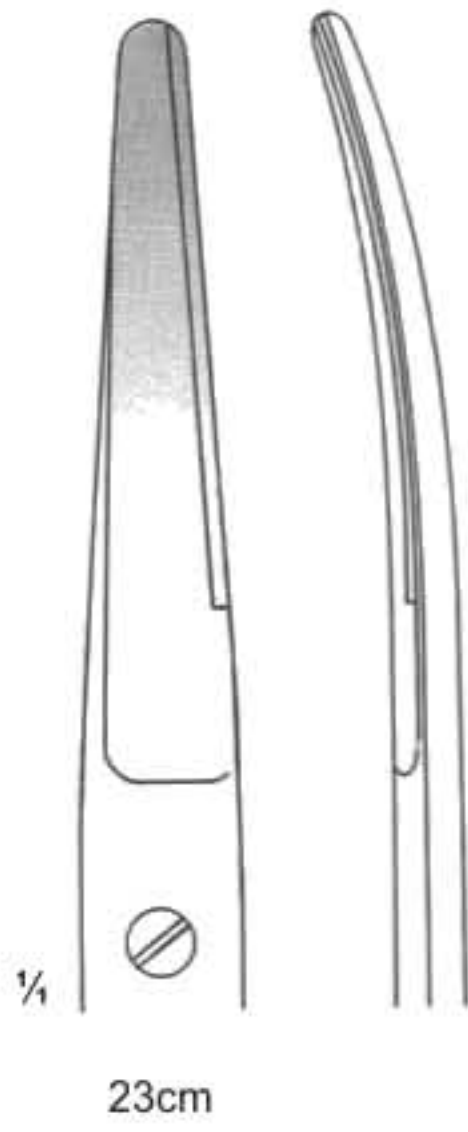

23cm

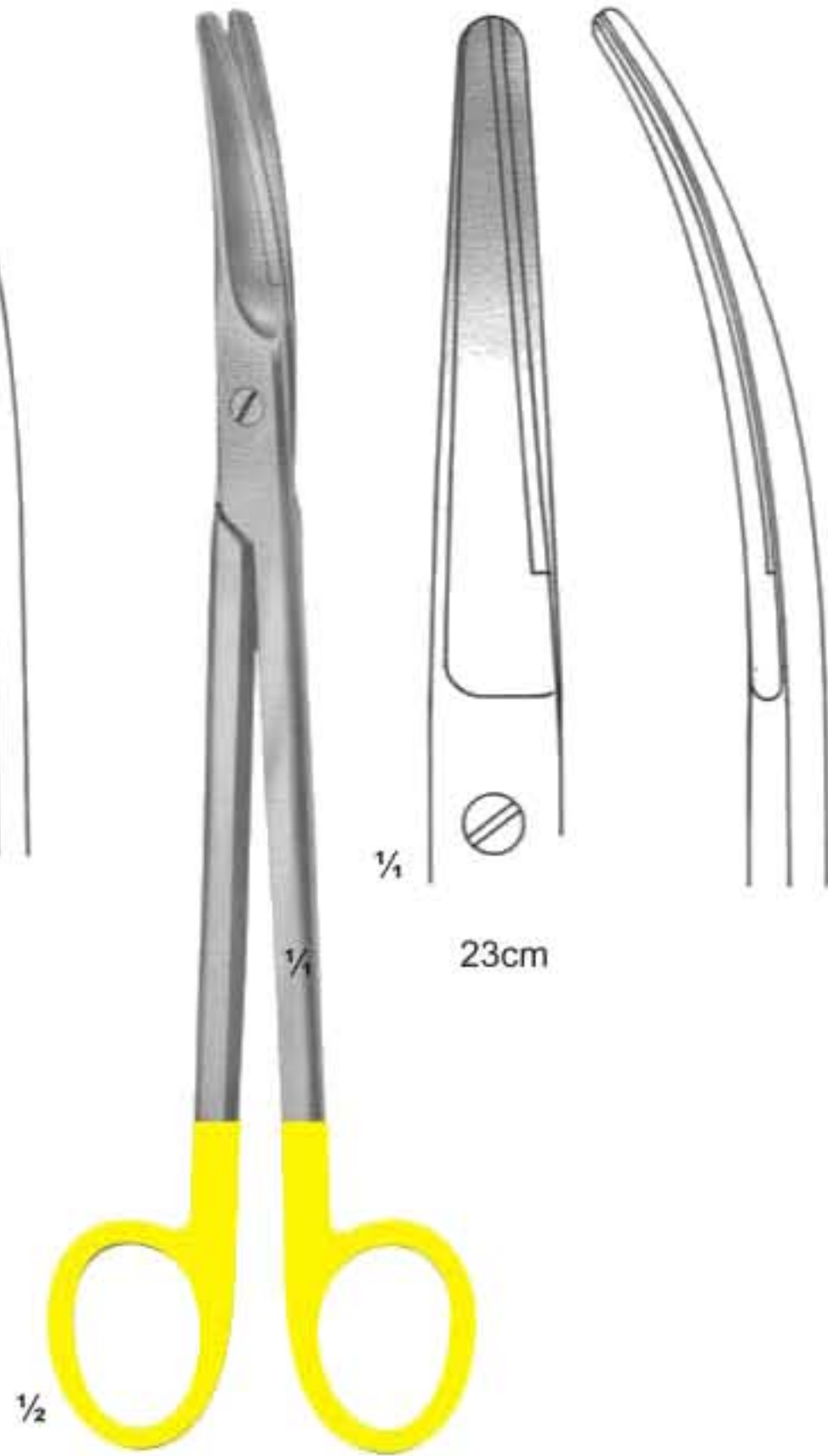

**3030**  
PARAMETRIUM

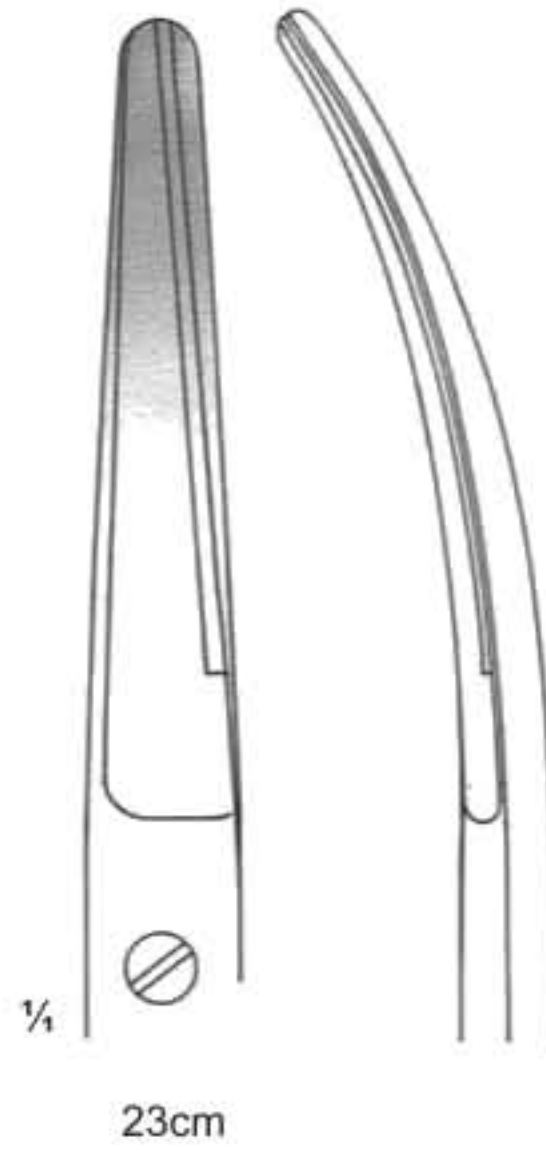

23cm

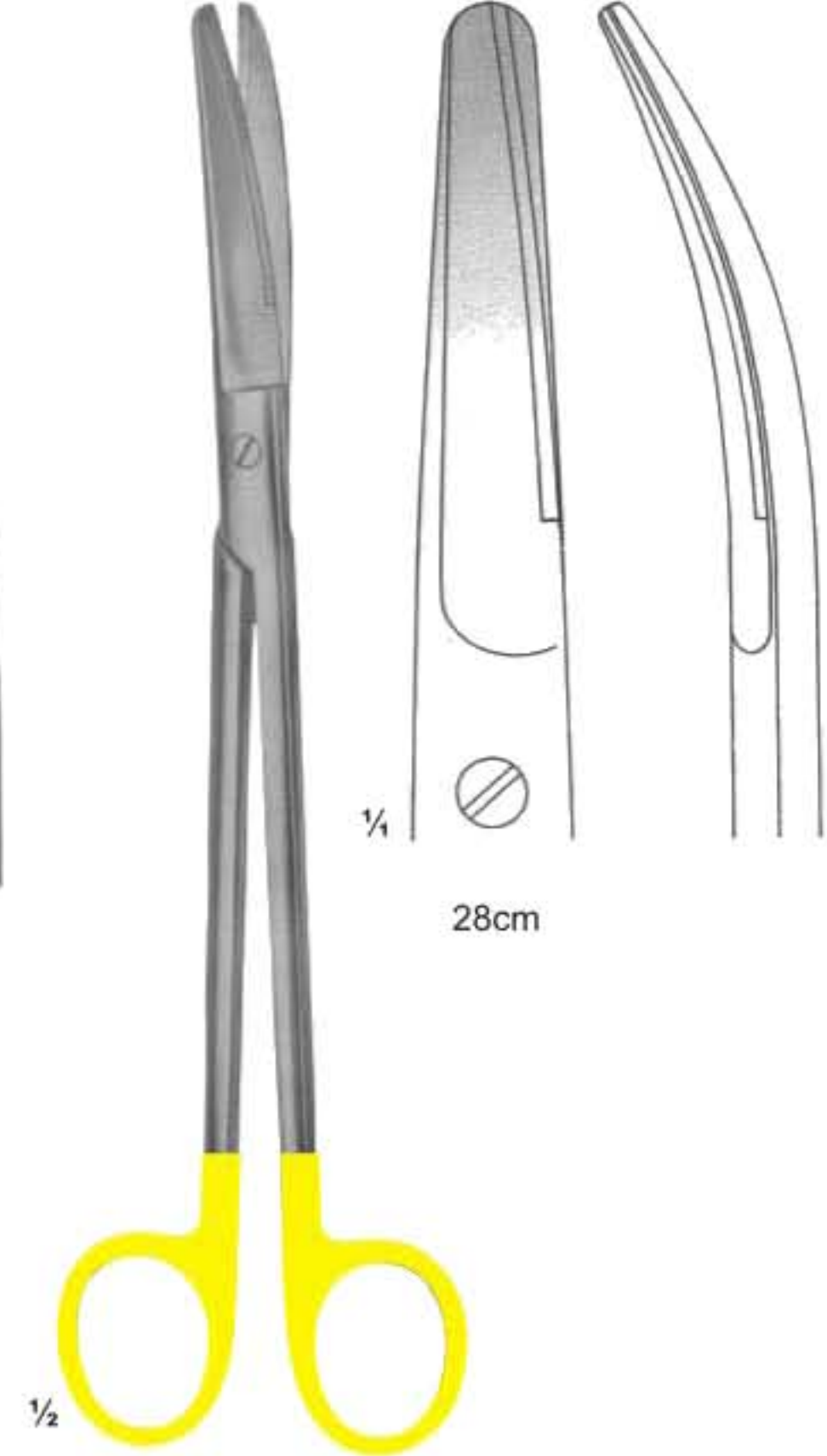

**3031**  
MAYO-HARRINGTON

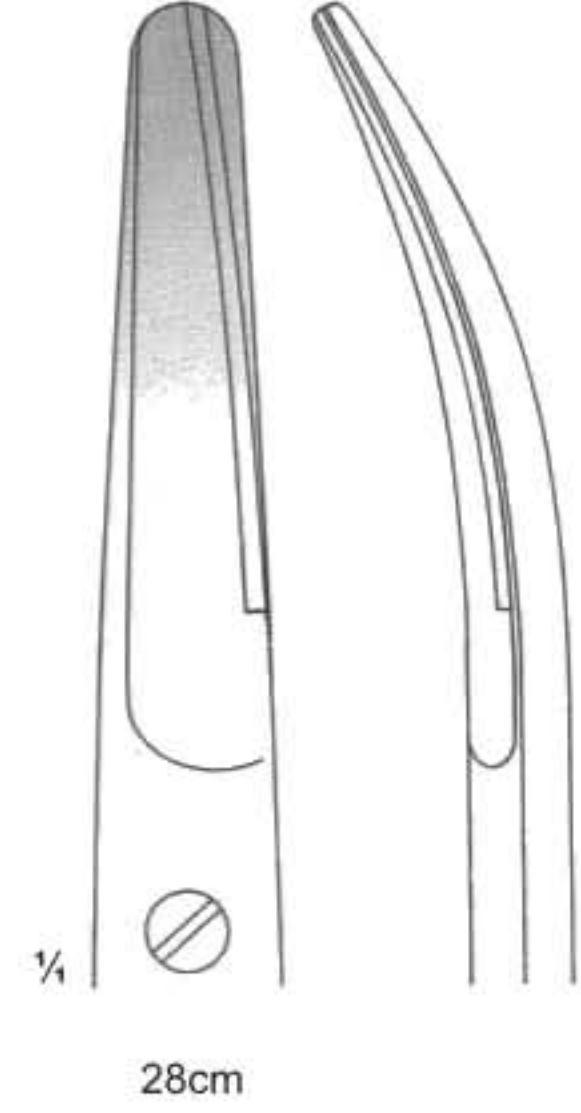

28cm



**3032**  
KELLY  
Straight 16 cm



**3033**  
KELLY  
Curved 16 cm



**3034**  
DEAN  
17 cm



**3035**  
LAGRANGE  
Double-Curved  
11.5 cm

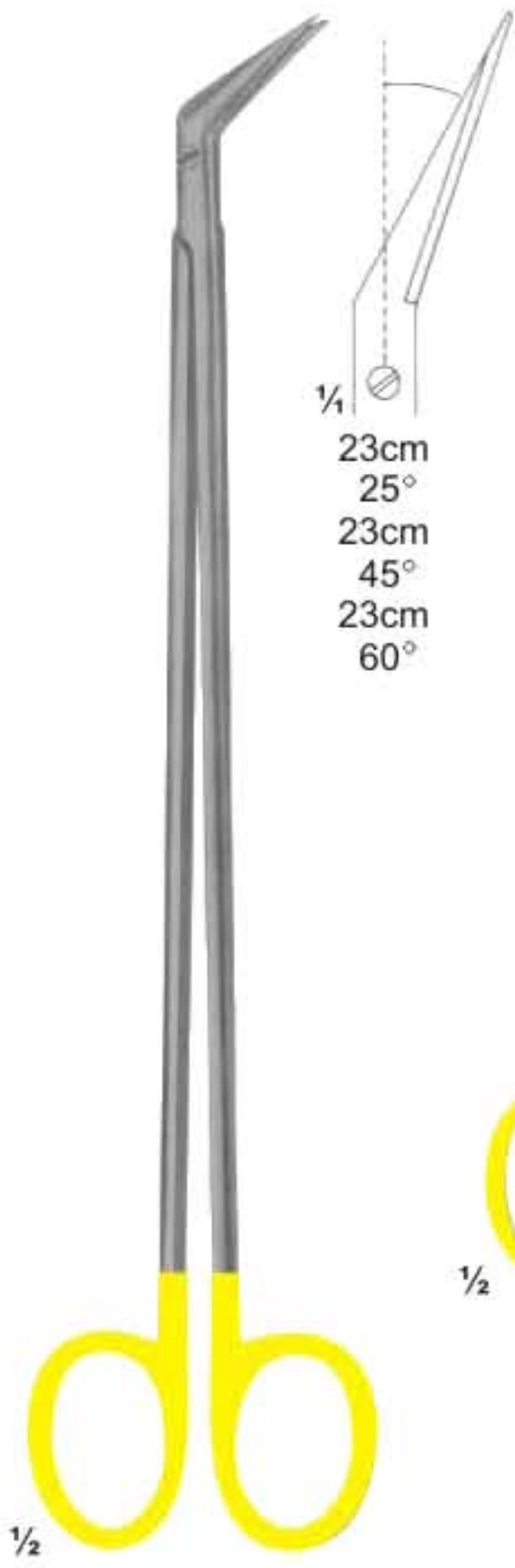

**3036**  
DE-BAKEY



**3037**  
DE-BAKEY

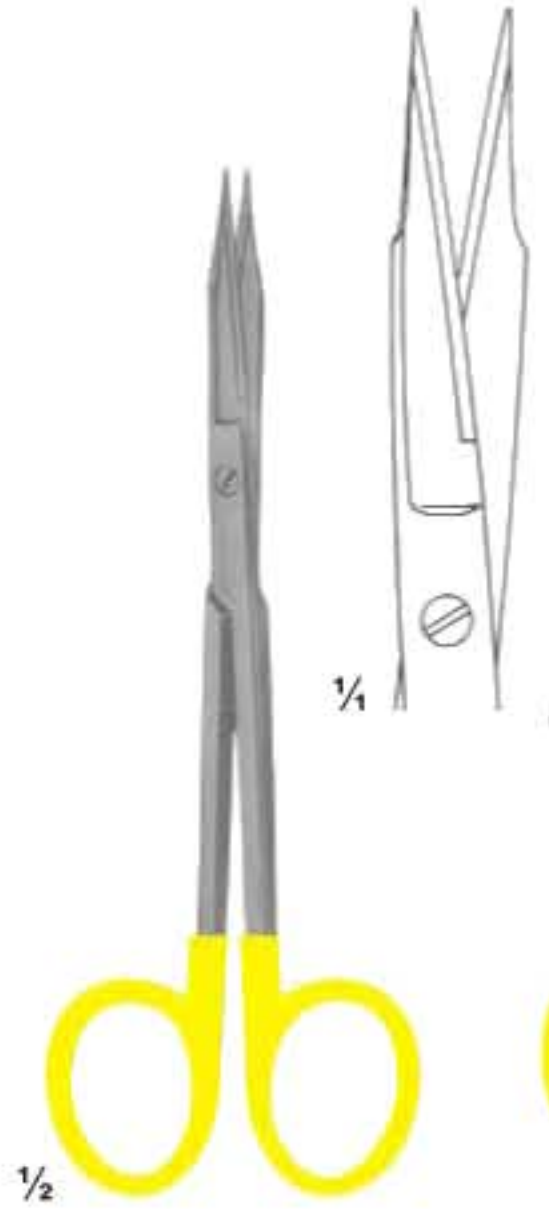

**3038**  
GOLDMAN FOX  
13 cm



**3039**  
GOLDMAN FOX  
Double-Curved  
13 cm

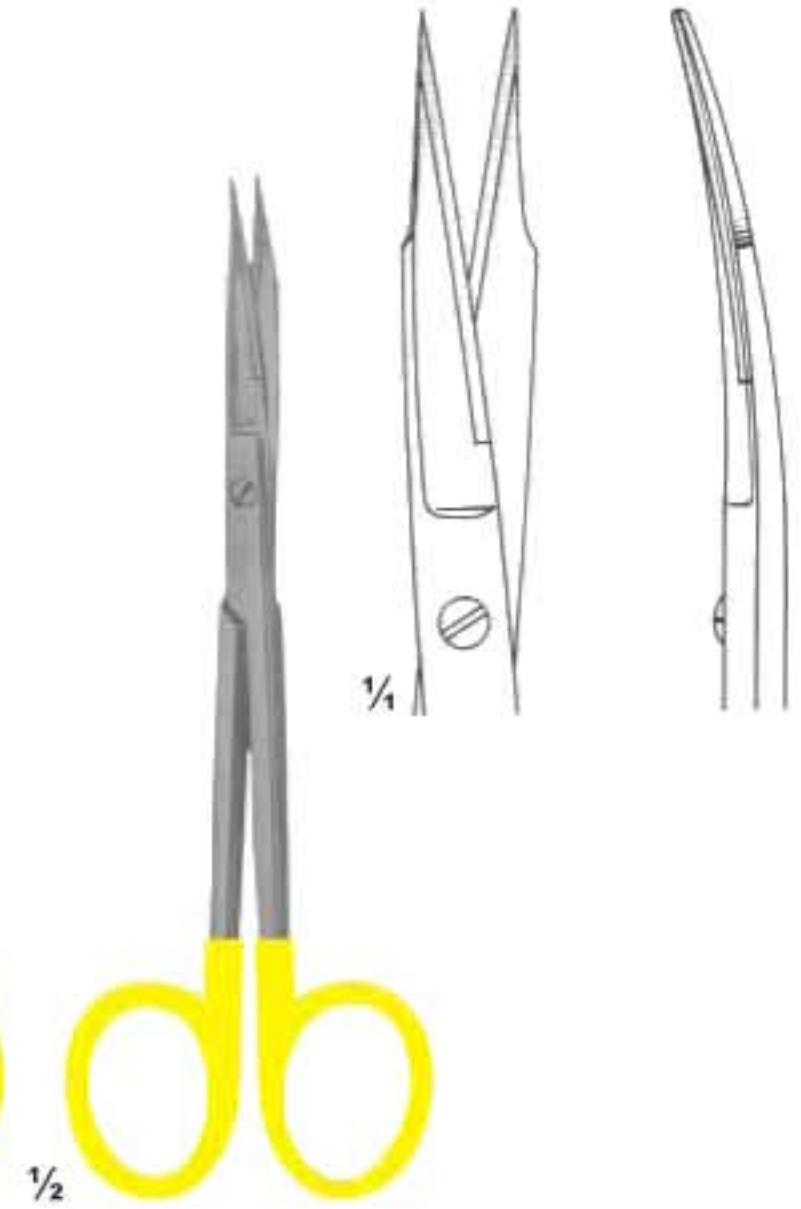

**3040**  
GOLDMAN FOX  
13 cm

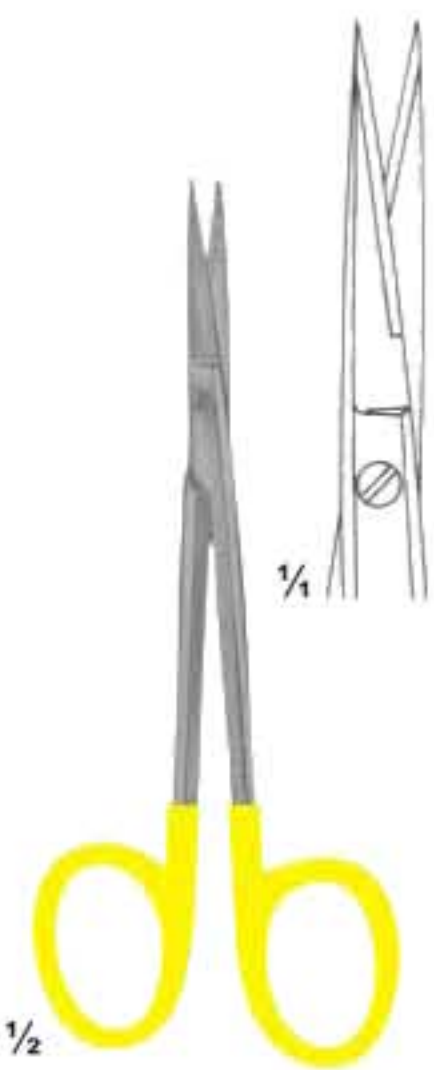

**3041**  
Fine Scissors  
Straight  
11, 5 cm

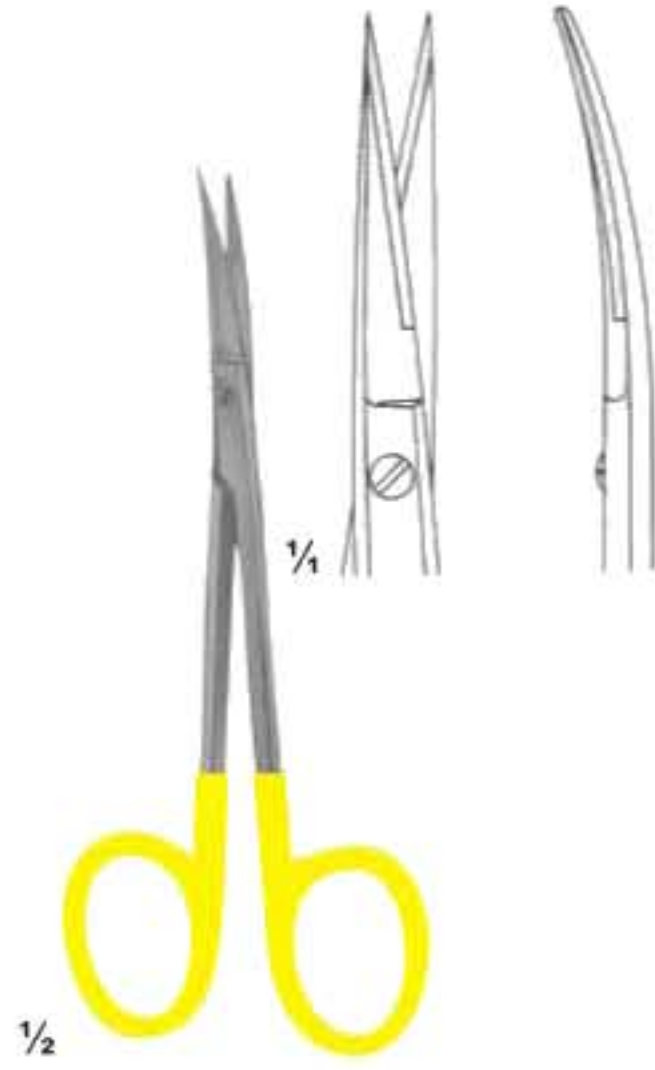

**3042**  
Fine Scissors  
Curved  
11, 5 cm

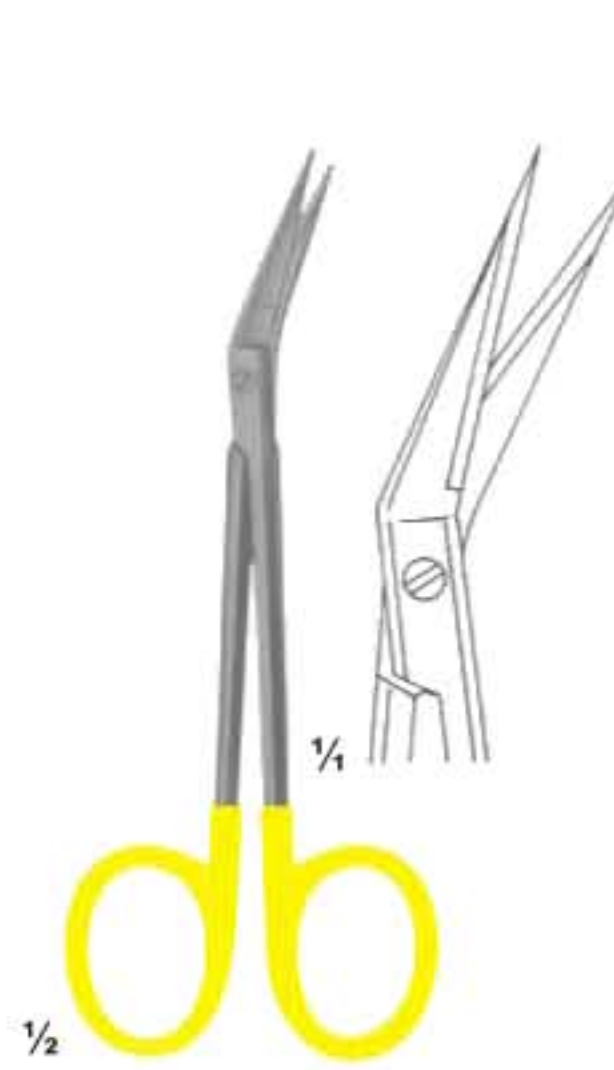

**3043**  
Fine Scissors  
Angled  
11, 5 cm

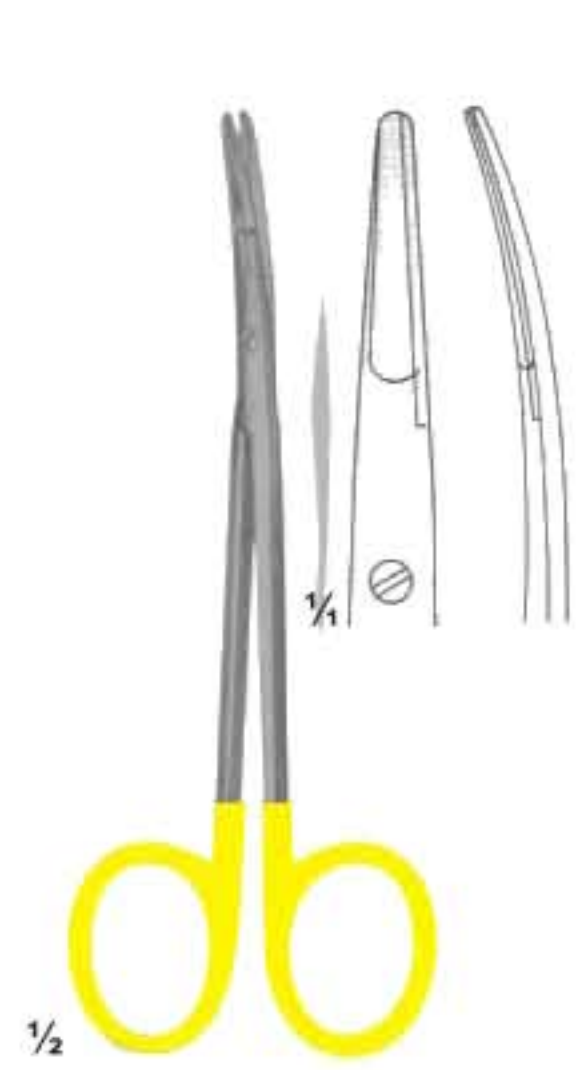

**3044**  
RAGNELL  
Curved  
12 cm

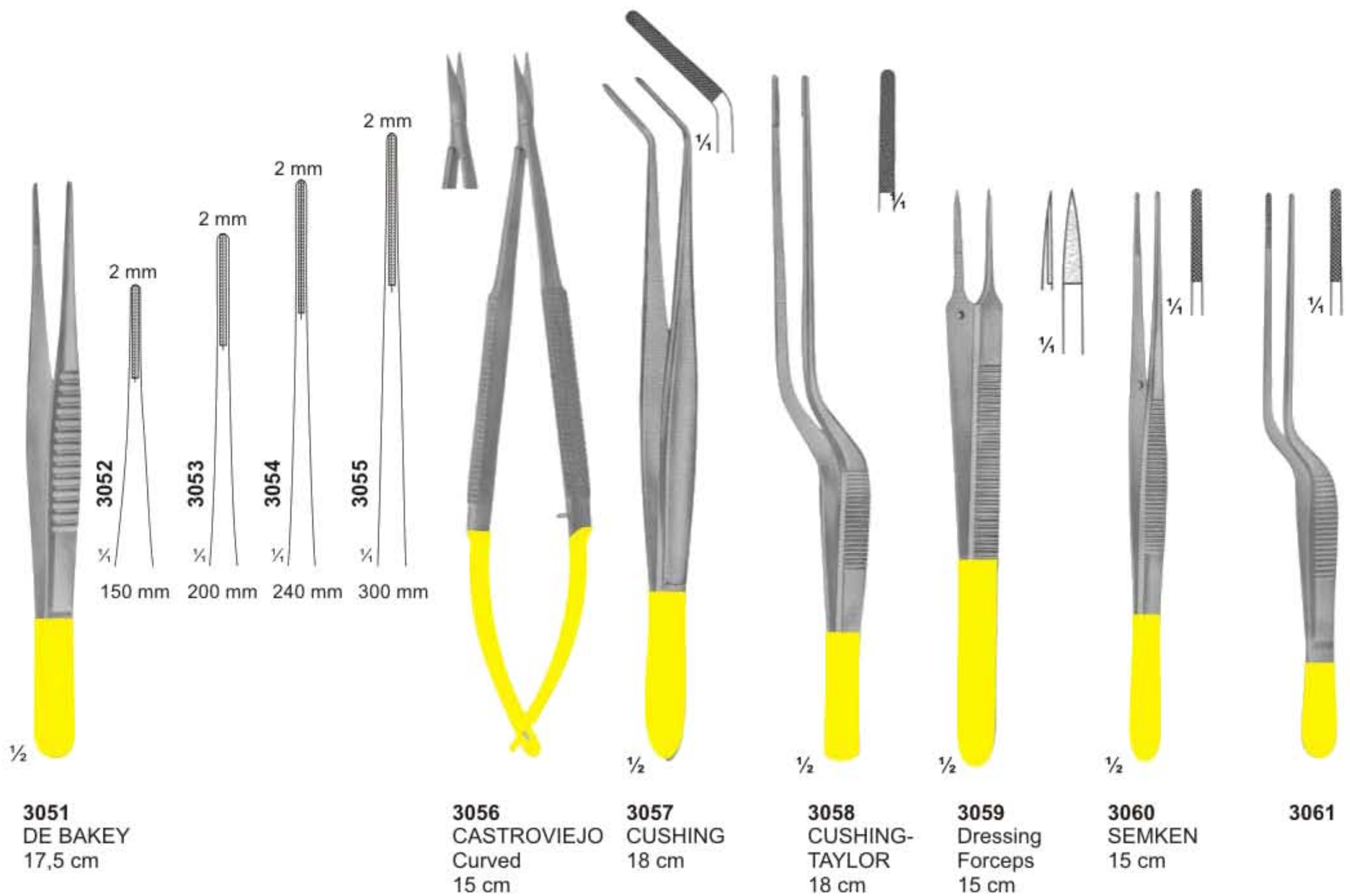
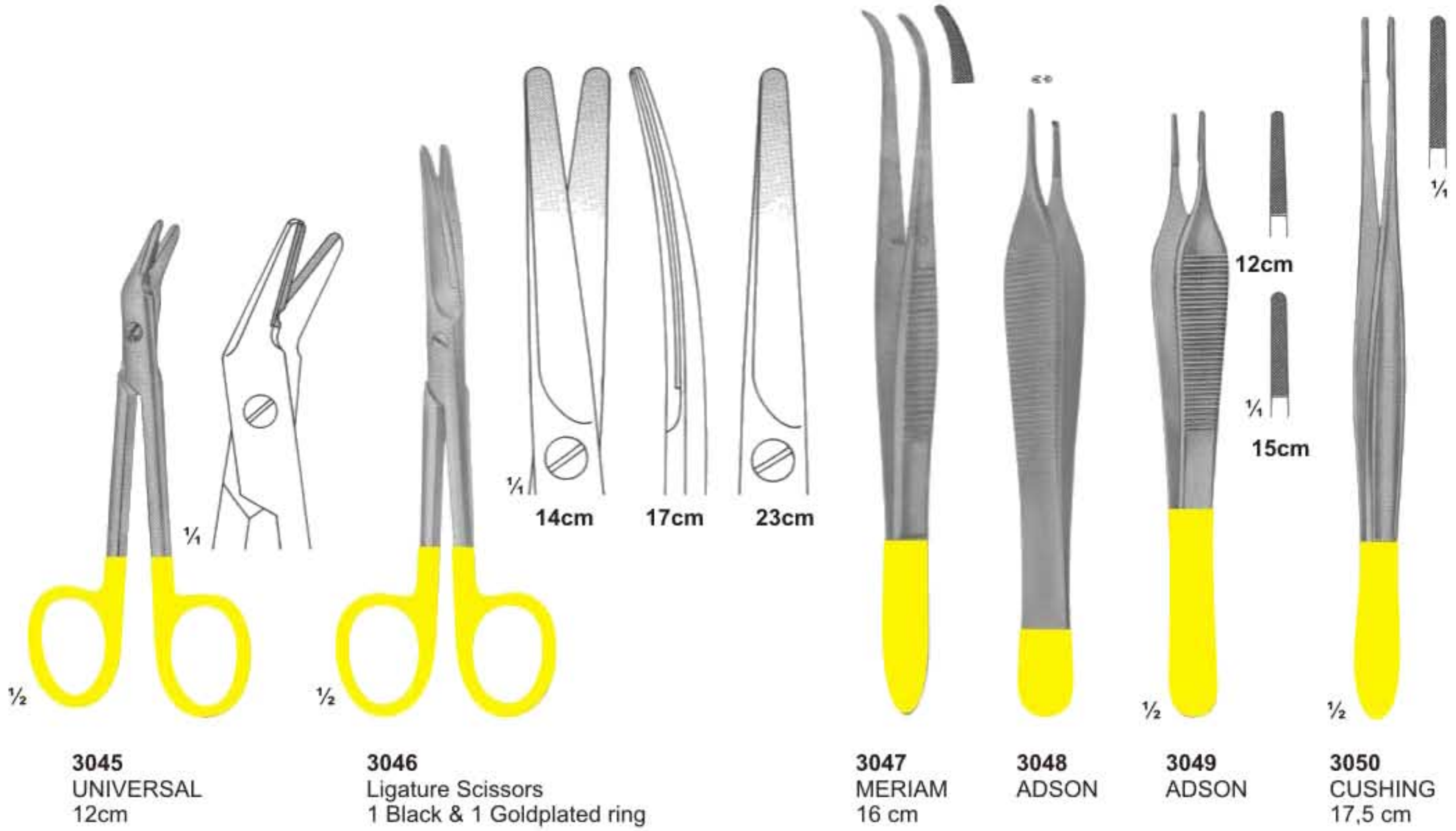

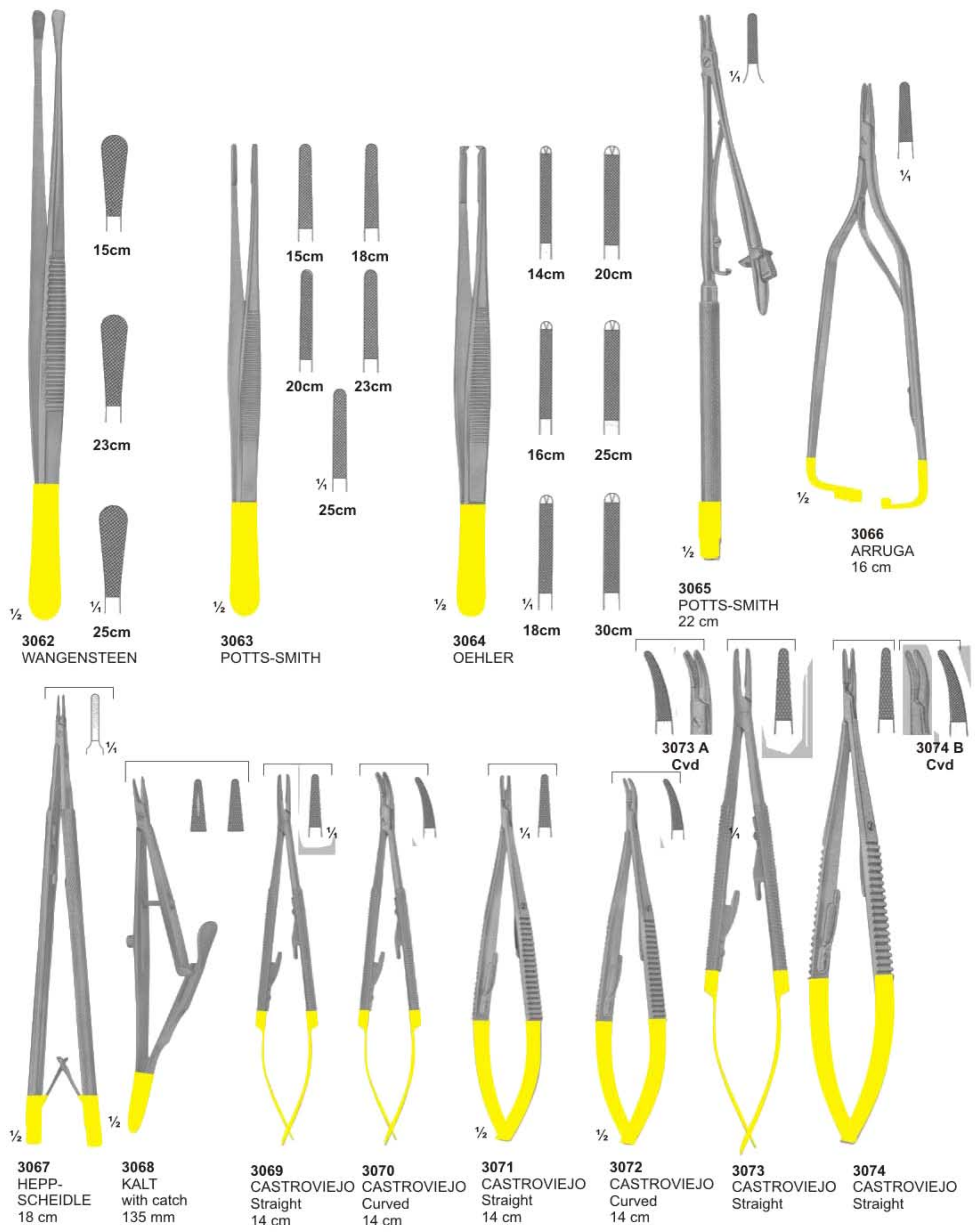

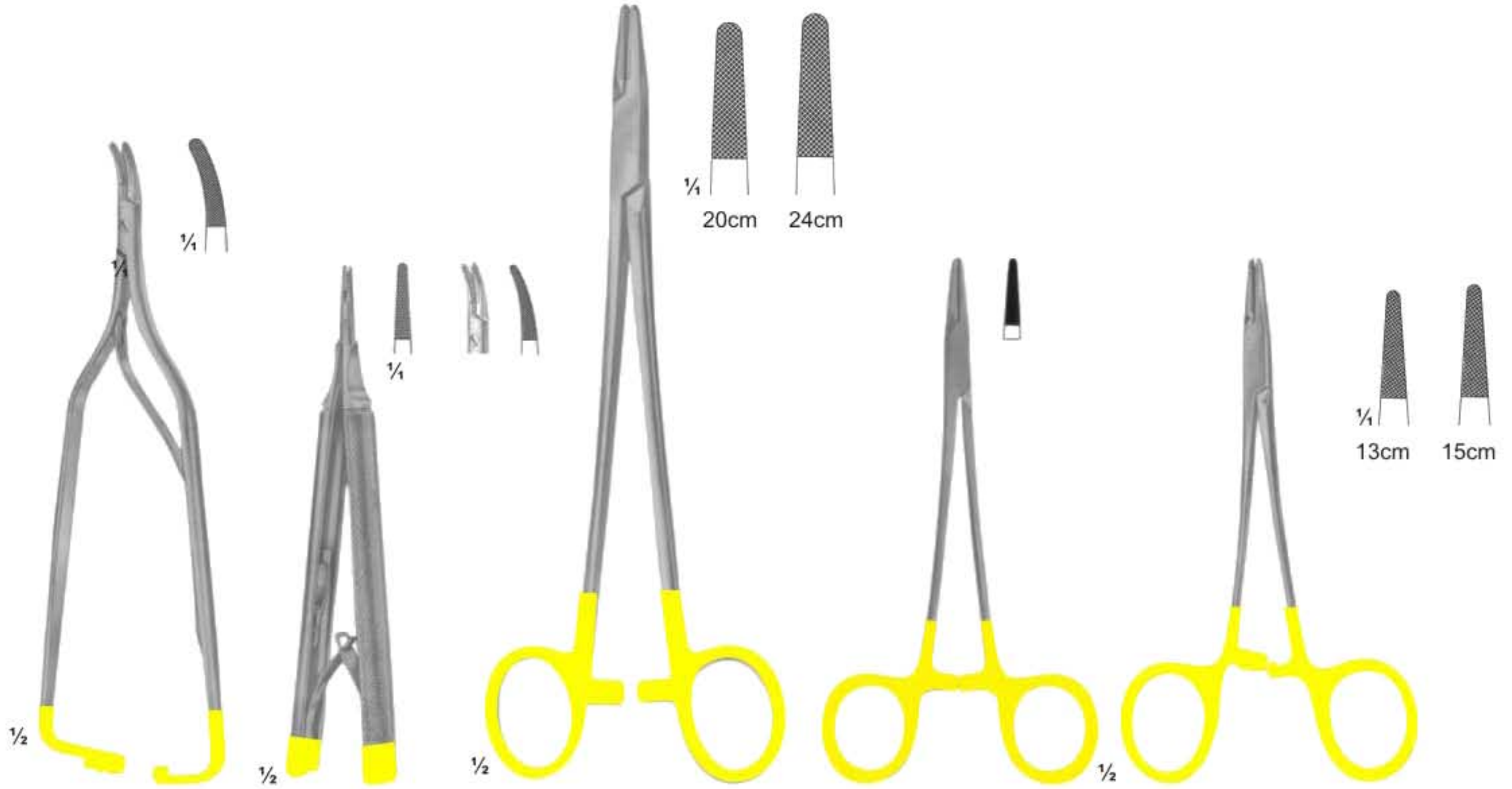

**3075**  
ARRUGA  
Curved  
16 cm

**3076**  
CASTROVIEJO  
13 cm

**3077**  
HEGAR  
20,24 cm

**3078**  
SMOOTH TIP  
15 cm

**3079**  
HALSEY  
13,15 cm

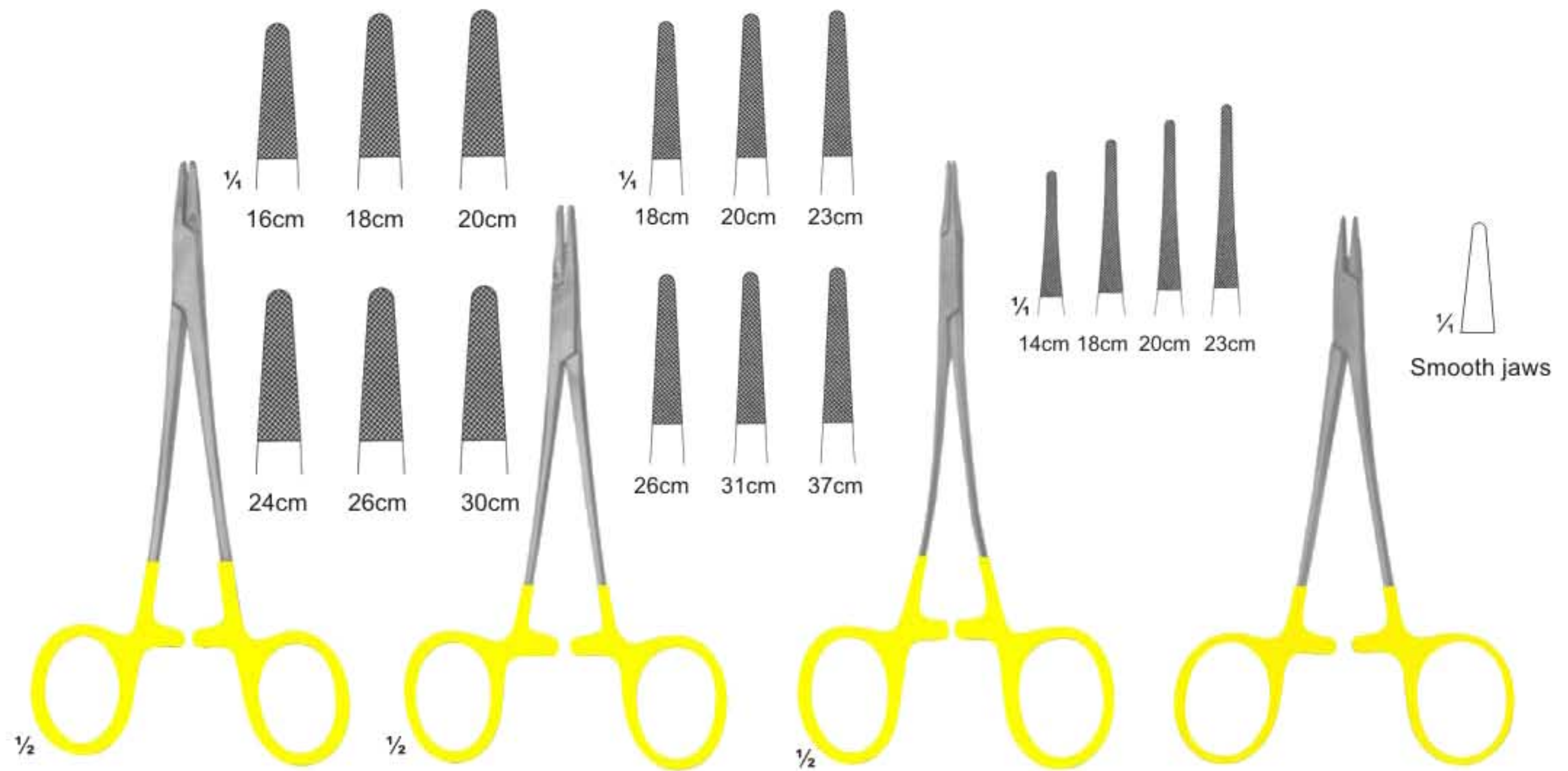

**3080**  
MAYO-HEGAR

**3081**  
DE BAKEY

**3082**  
HEGAR-VASCULAR

**3083**  
WEBSTER  
125 mm

# Needle Holders With Tungsten Carbide Inserts

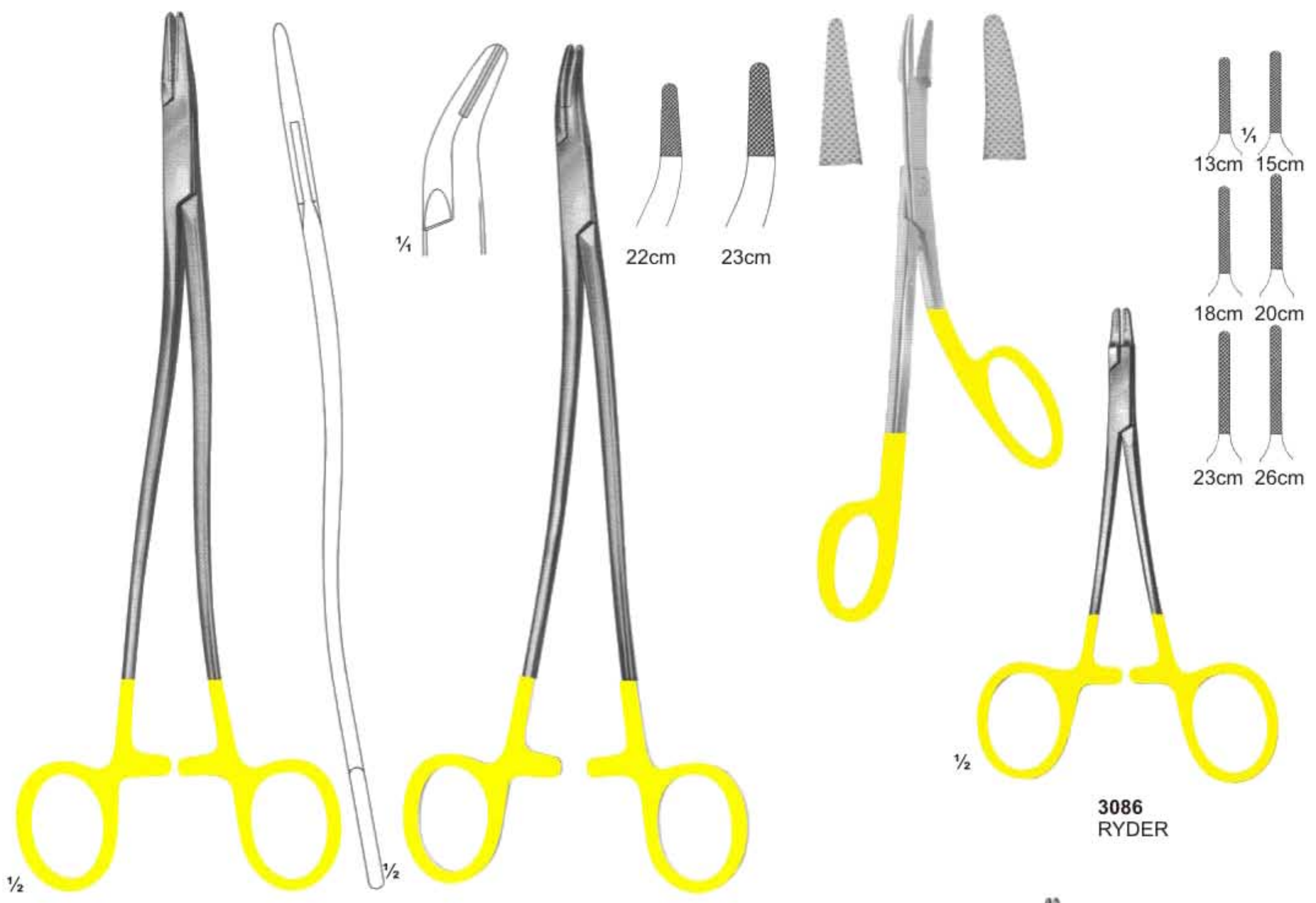

**3084**  
BOZEMANN-WERTHEIM  
20, 24, 26 cm

**3085**  
STRATTE

**3086**  
RYDER

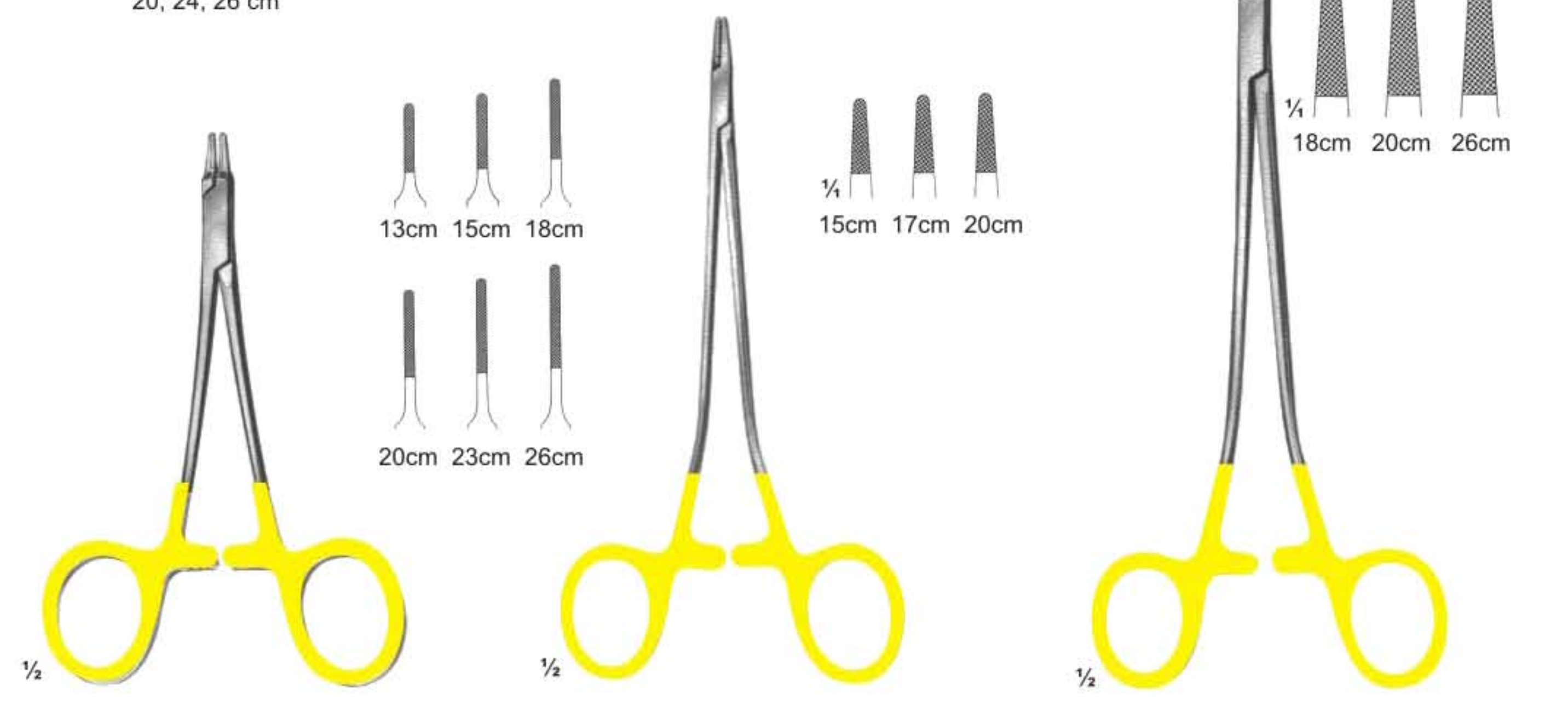

**3087**  
RYDER-VASCULAR

**3088**  
MARTIN

**3089**  
SAROT

# Needle Holders With Tungsten Carbide Inserts

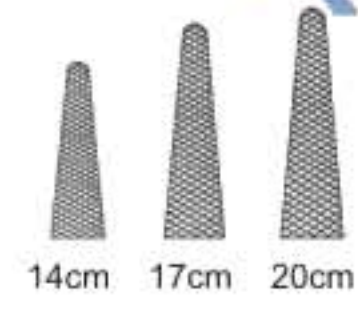

**3090**  
FINOCHIETTO  
27 cm

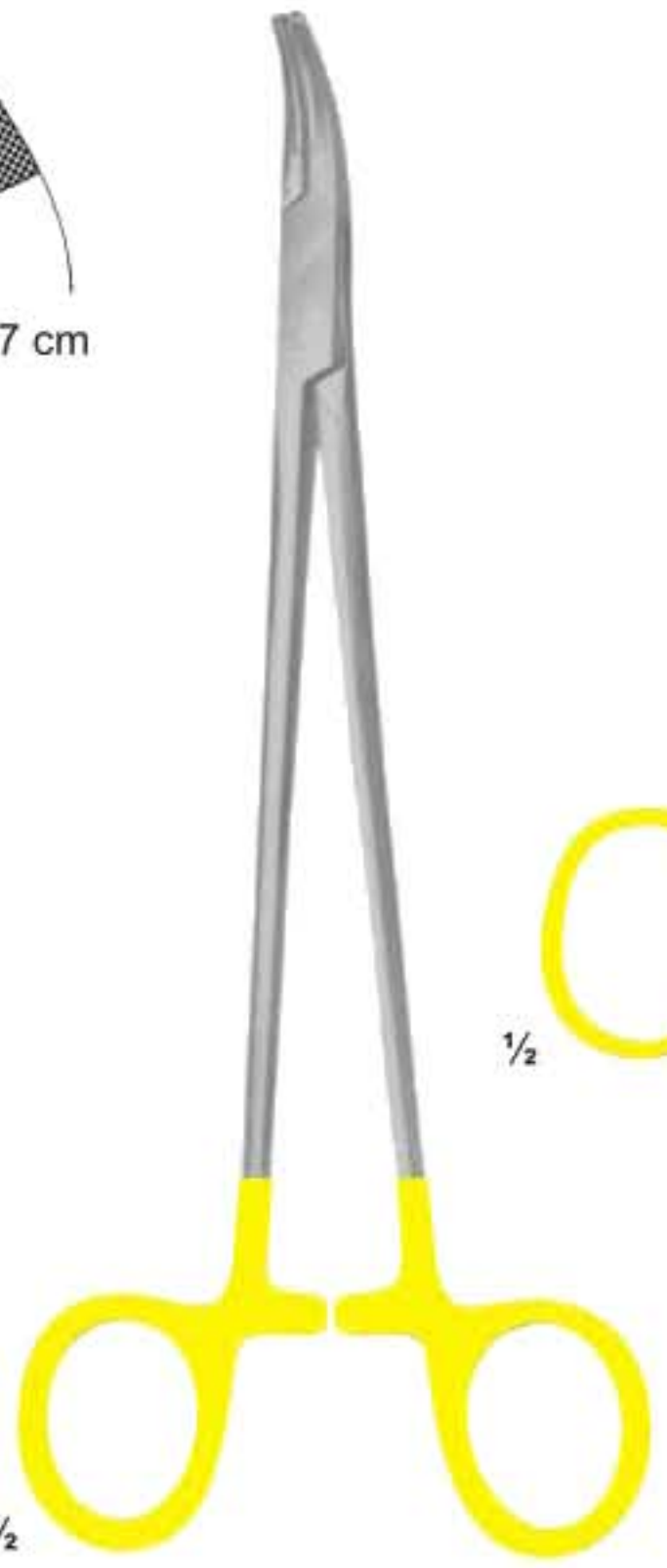

**3091**  
HEANEY  
27,24 cm

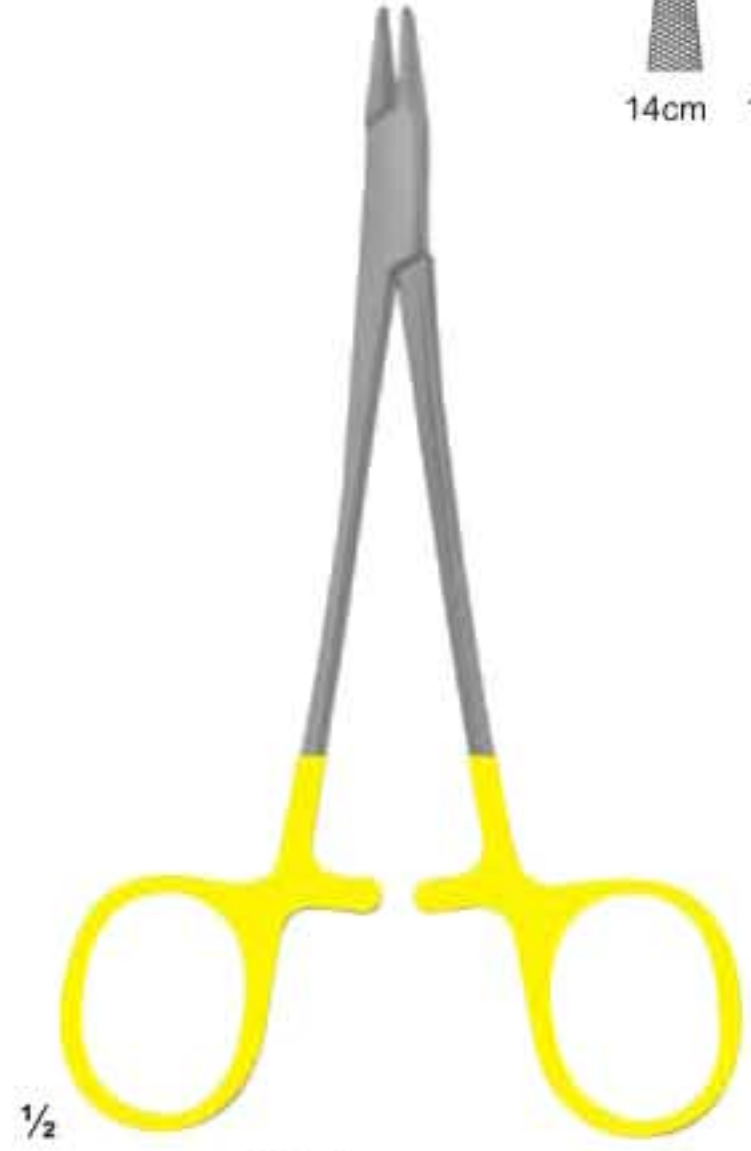

**3092**  
BAUMGARTNER  
145 mm

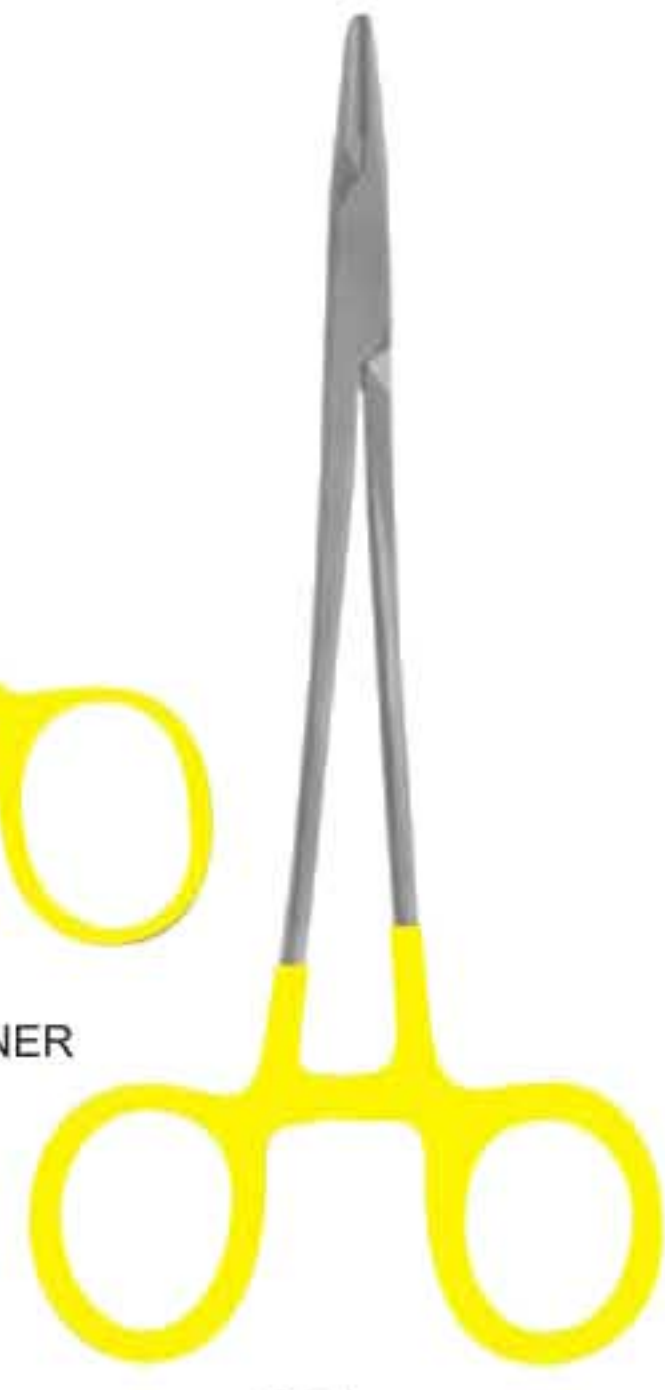

**3093**  
CRILE-WOOD  
15 cm



**3094**  
MATHIEU



**3095**  
MATHIEU  
14,17,20 cm



**3096**  
MATHIEU-KOSHER  
14,17,20,24 cm



**3097**  
MATHIEU-KOSHER  
17,20,24 cm



**3098**  
MATHIEU-VASCULAR  
17,20,24 cm



**3099**  
MATHIEU-VASCULAR  
Hosel  
17,20 cm

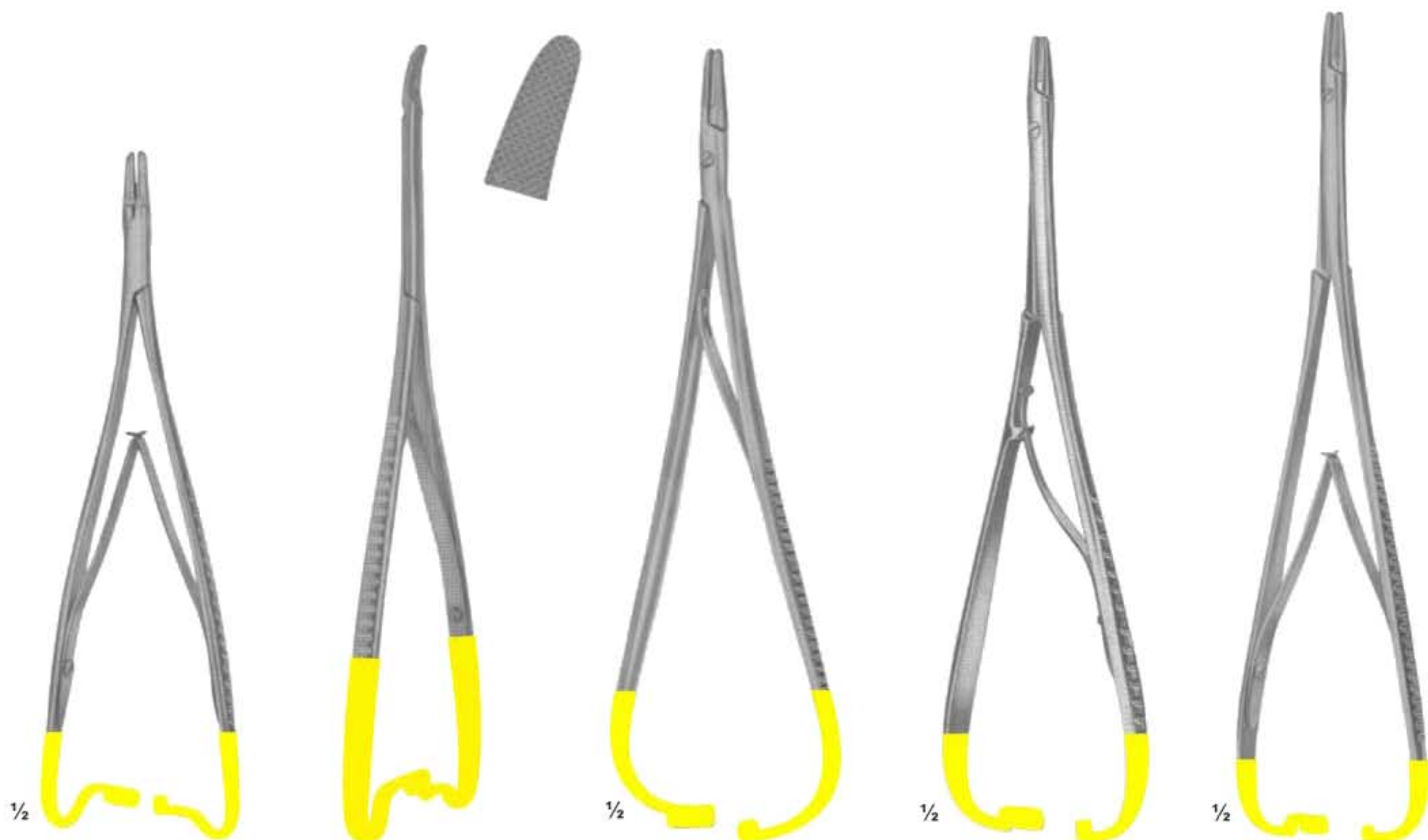

**3100**  
MATHIEU-RYDER  
17,20,24 cm

**3101**  
Hosel  
Curved  
20 cm

**3102**  
LICHTENBERG  
20 cm

**3103**  
LANGHALS  
20,25 cm

**3104**  
LICHTENBERG  
20,25 cm



**3105**  
LUEHTY-BECK  
20,25 cm



**3106**  
LUEHTY-BECK  
20,25 cm



**3107**  
LANGENBECK  
18,20,23 cm

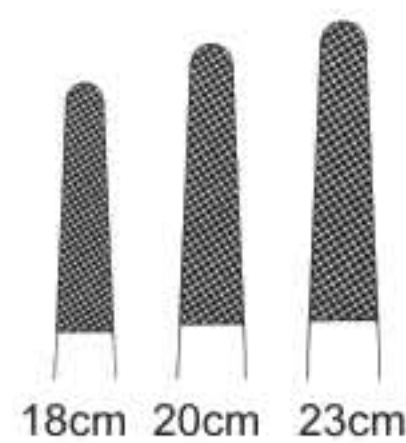

**3108**  
LANGENBECK  
18,20,23 cm





**3109**  
TOENNIS  
Elastic pattern for  
dura-or intestinal suture  
180 mm

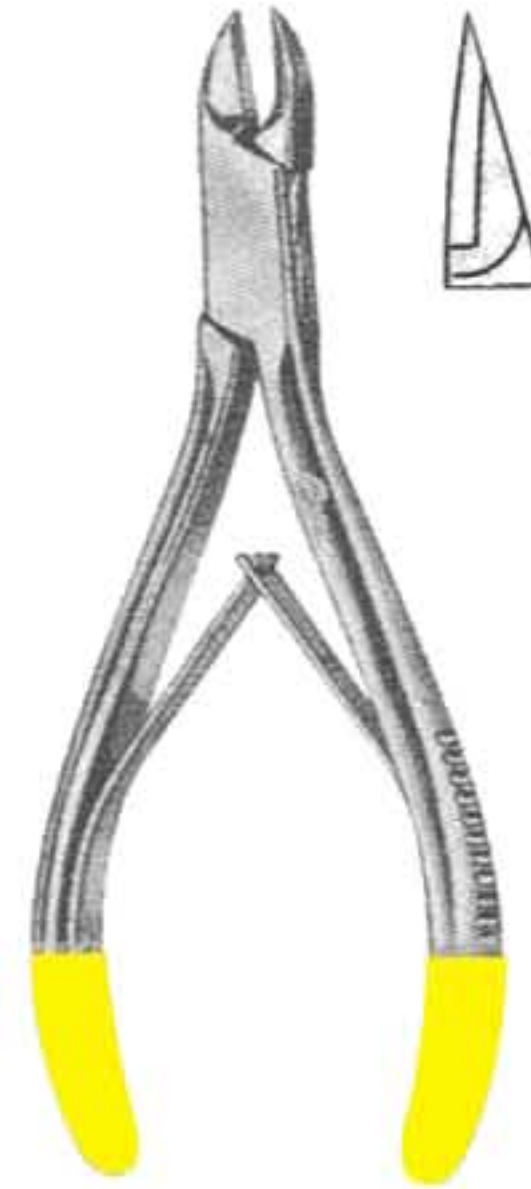

**3110**  
Cutting Plier  
12 cm

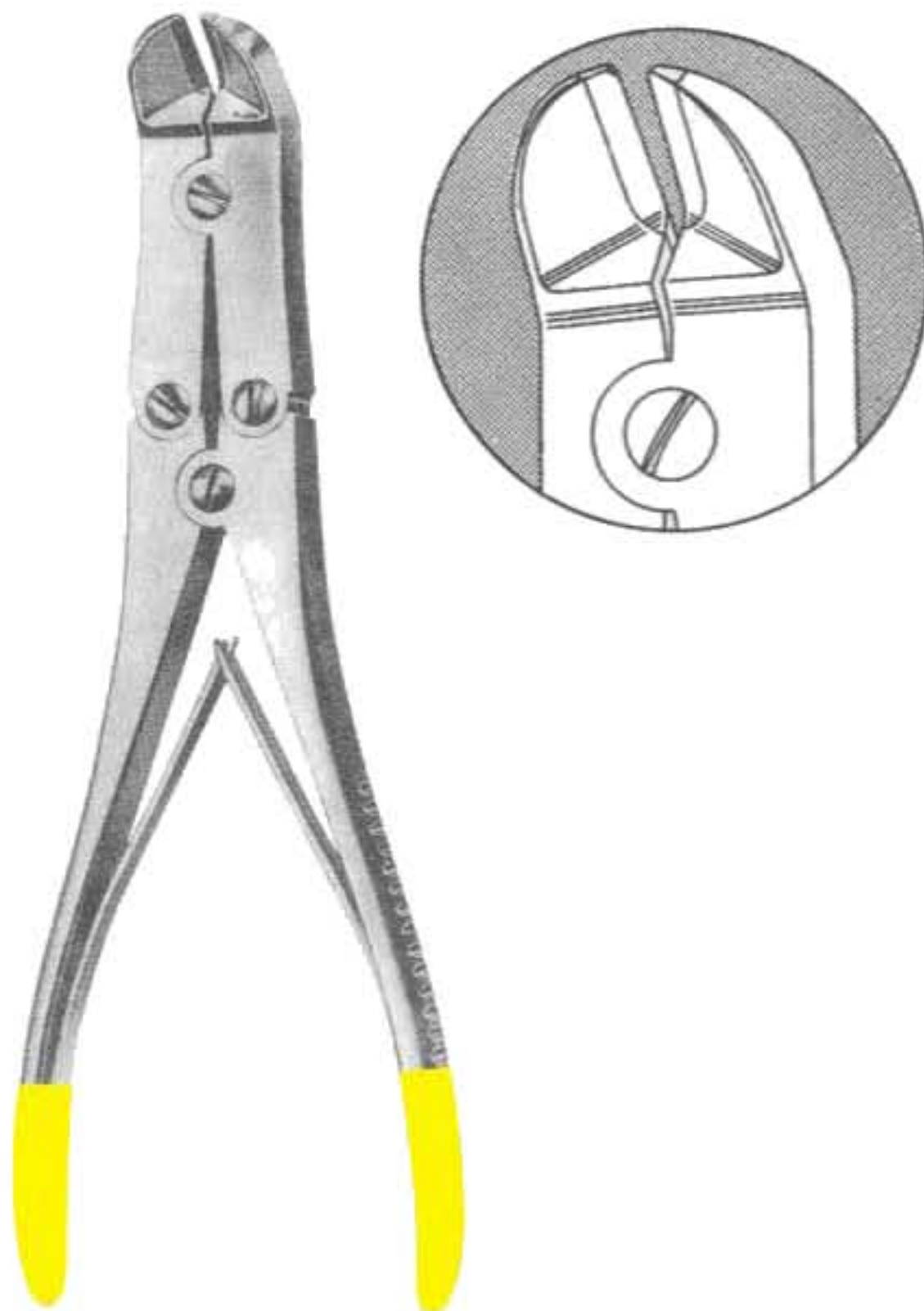

**3111**  
MULLAR CLAUS  
22 cm

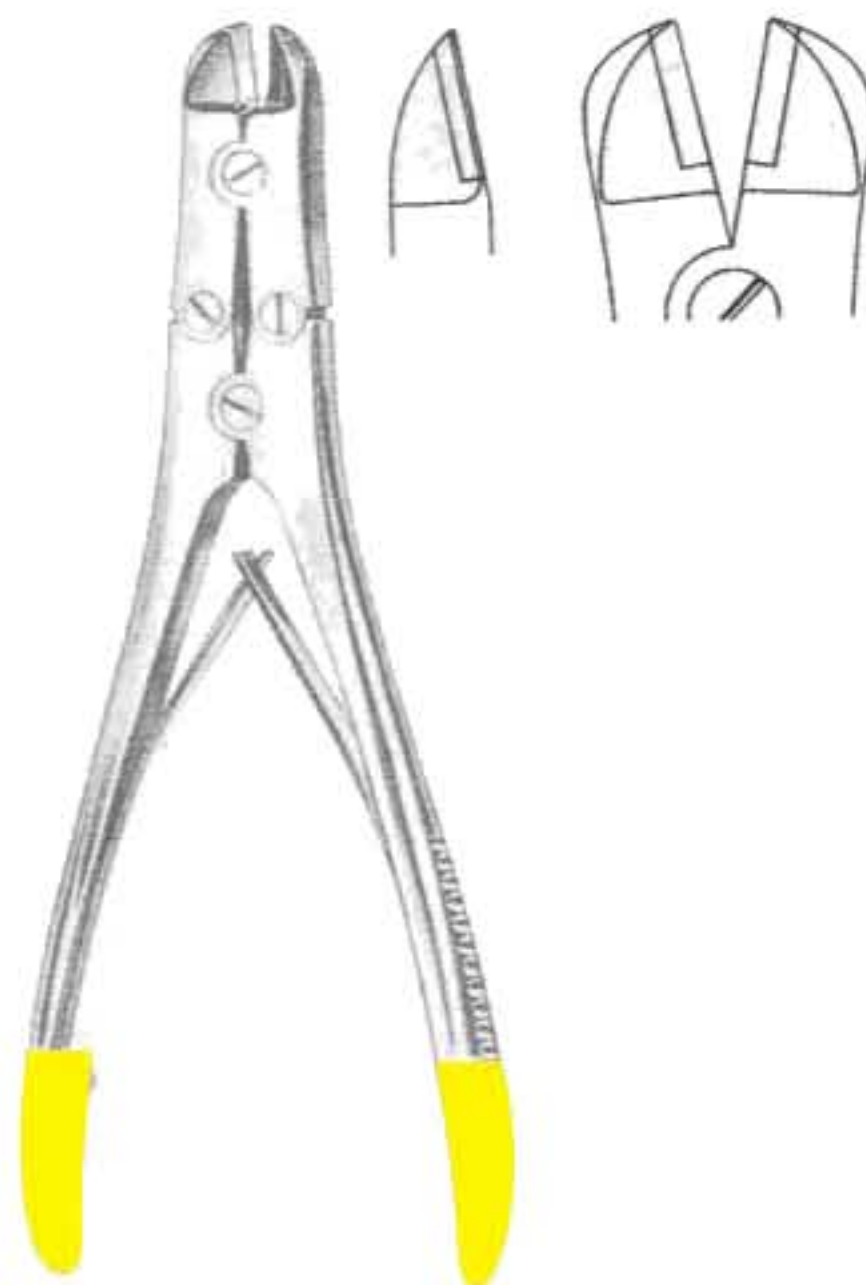

**3112**  
Plier  
17.5 cm



**3201**  
Root Elevator



**3202**  
Root Elevator



**3203**  
Osteotomes  
Pointed



**3204**  
Osteotomes  
Pointed



**3205**  
Osteotomes Convex  
Rounded Set of Five



**3206**  
Luxator Set 7 Pcs

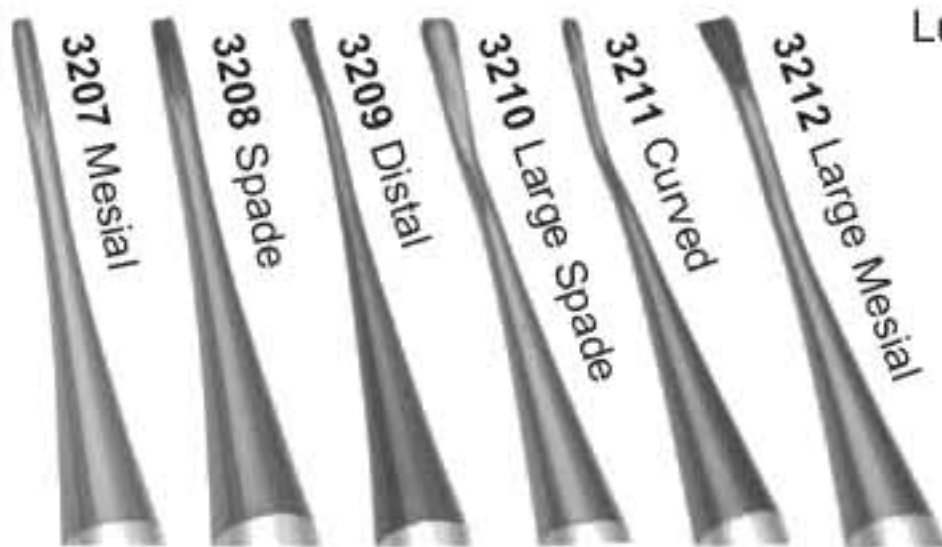

**3213**  
Periodontal chisel  
5mm / 3mm



**3214**  
Sinus lift # 1  
Set of Five

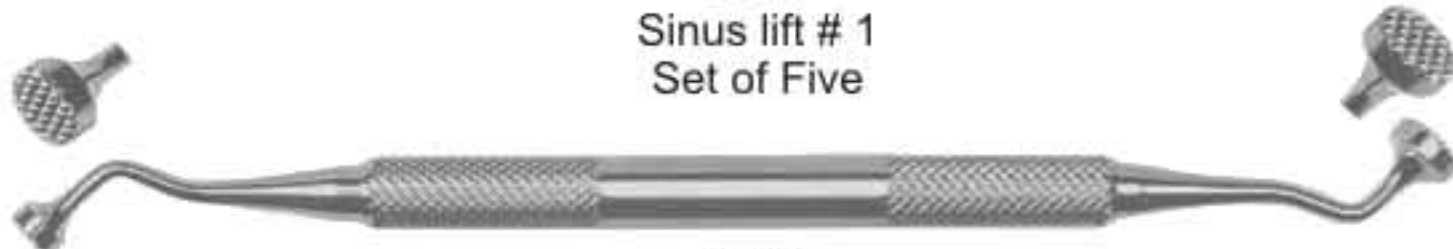

**3215**  
Large Bone Packer  
Serrated 5mm 7mm



**3216**  
Labanca



**3217**  
Sinus lift instruments



**3218**  
Sinus lift instruments



**3219**  
Replacement blade bone scraper  
(curved) Three Type



**3220**  
Adjustable-angle  
Scalpel Blade Handle



**3221**  
Replacment Blade  
Bone Screper (streight)



**3222**  
Bone Tamper 4mm  
Searted Tip



**3223**  
Bone Chisel



**3224**  
Double Ended  
Explorer



**3225**  
Scaler



**3226**  
Scaler



**3227**  
Scaler



**3228**  
Scaler



**3229**  
Frazier Suction tube  
2.5 mm diameter



**3230**  
luxator set 7 pcs  
mesial curved



**3231**  
luxator set 7 pcs  
mesial curved



**3232**  
Bone Grafting  
Syringe



**3233**  
inter-ligmental  
Syringes



**3234**  
inter-ligmental  
Syringes



**3235**  
Adjustable Torque  
Wrench



**3236**  
Mucotomes  
(straight)



**3237**  
Bone Miller



**3238**  
Bone Well



**3239A**  
**3239**  
Implant Torque Wrench with  
Hex Rivet Nut 1.25 mm

**3239B**  
**3239C**  
Drill Bits  
**3239D**



**3240**  
Fig. 1 / Hemingway



**3241**  
Fig. 2 / Hemingway



**3242**  
Fig. 3 / Hemingway

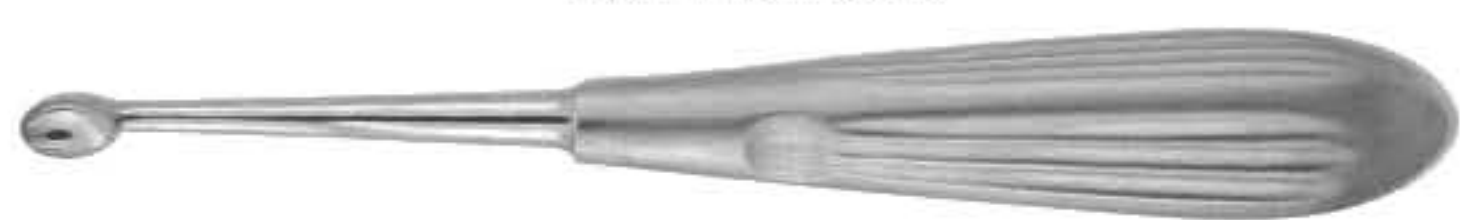

**3243**  
Fig. 3

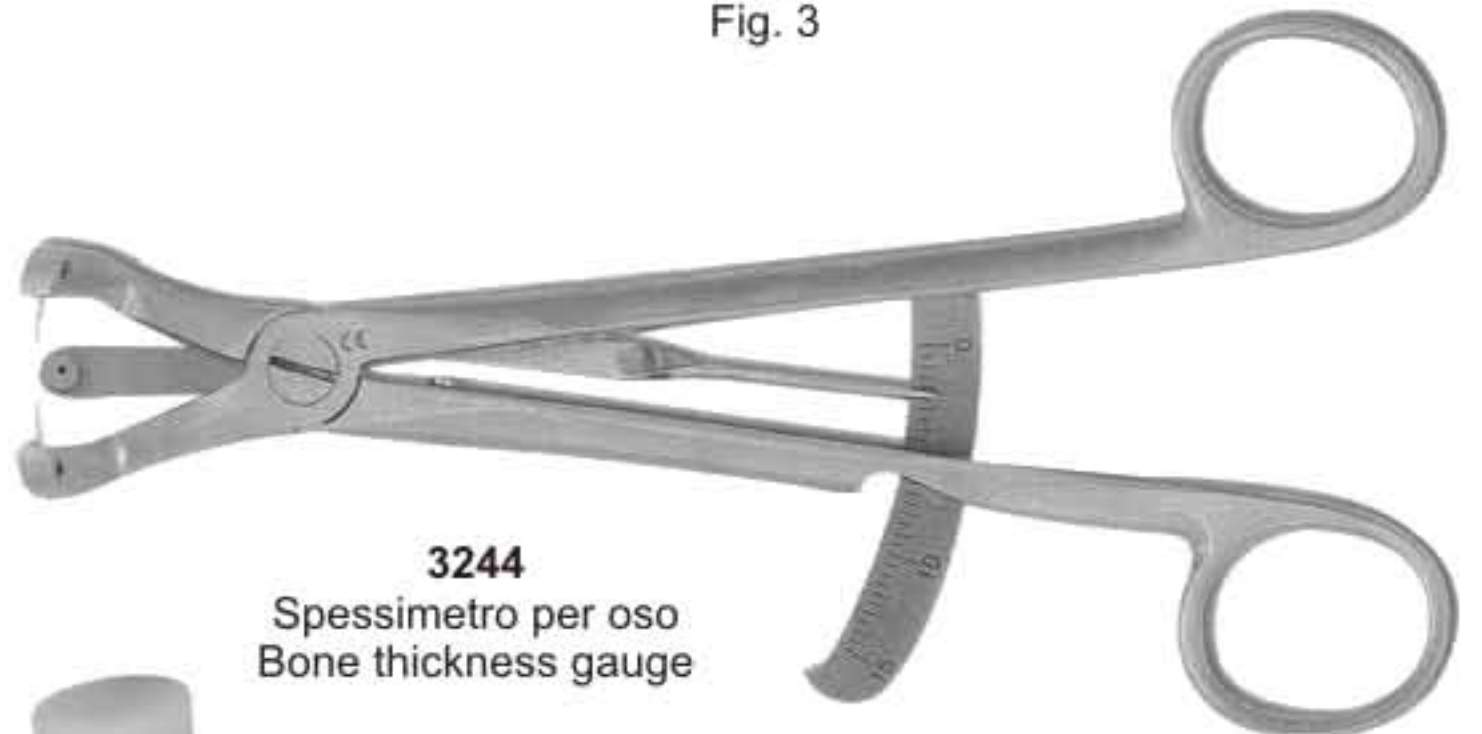

**3244**  
Spessimetro per oso  
Bone thickness gauge



**3245**  
MALLET



**3246**  
Dental implant fixture  
removal kit

- >trephines
- >drivers
- >end cutters

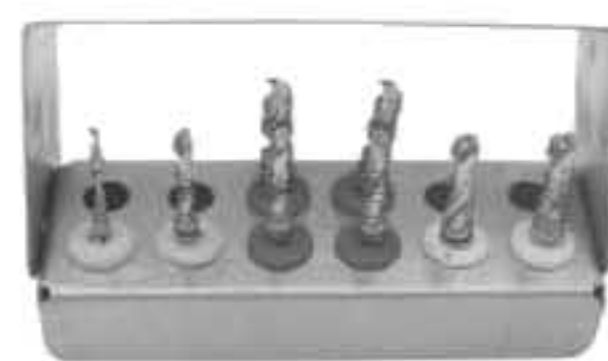

**3247**  
Dental Trepine Drills  
Set of Seven

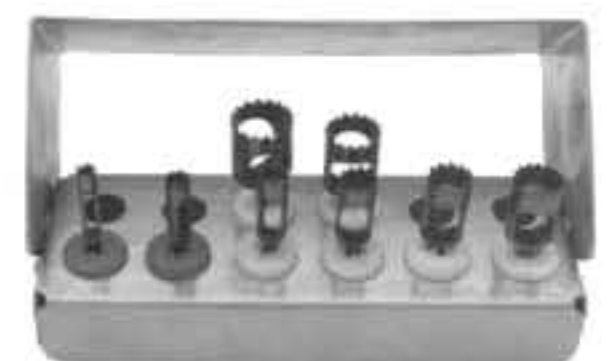

**3248**  
Dental Trepine Drills  
Set of Ten



**3249**  
Set of 8 Pcs



**3250**  
Set of 5 Pcs



**3251**  
Set of 5 Pcs

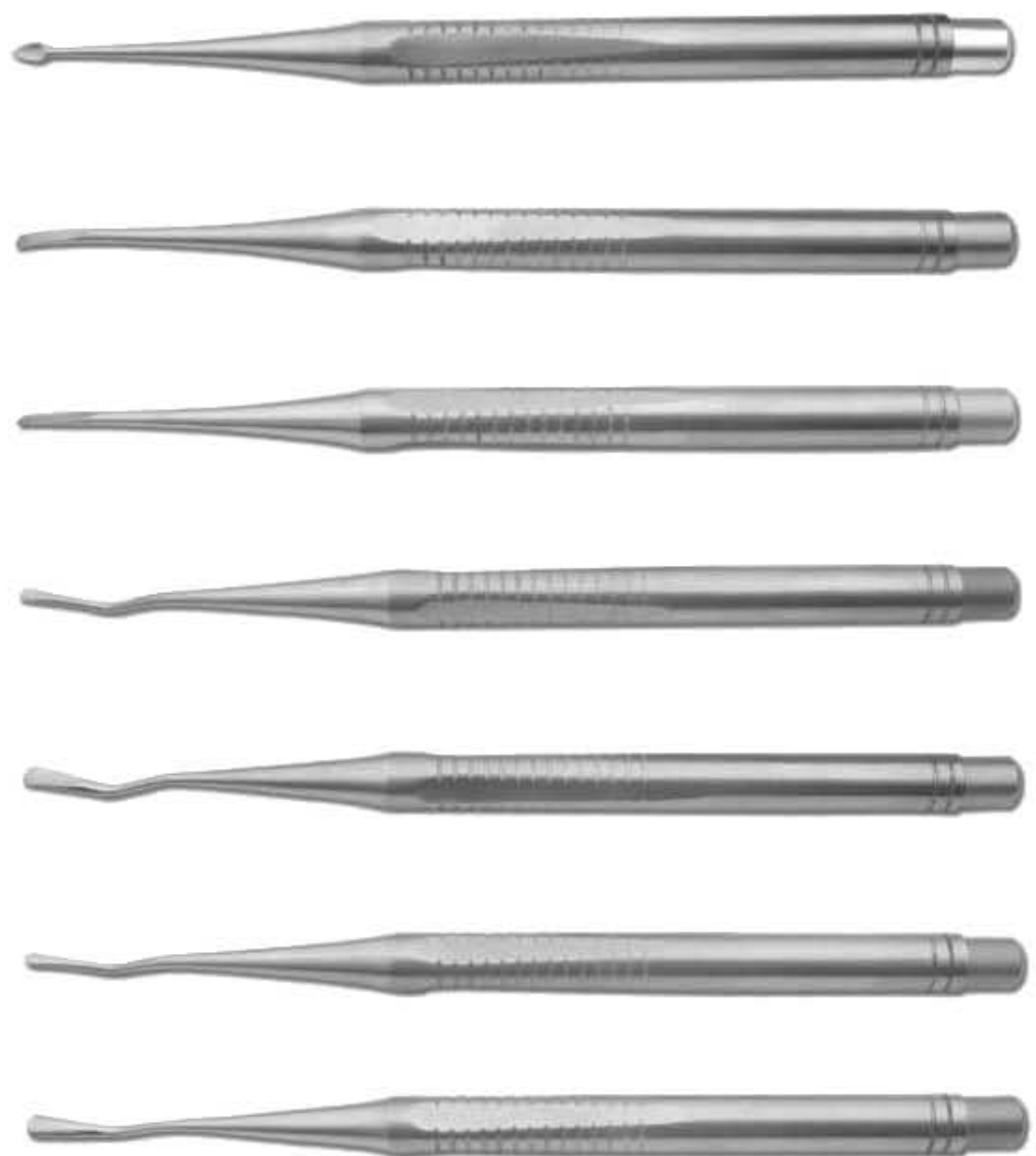

**3252**  
Set of 7 Pcs



**3253**  
Tooth Extracting Forceps Kit (Set of 12 pcs)  
Fig #: 1,7,13,17,18,51A,67A,73,74N,86,89,90



**3254**  
Pedo Forceps Kit (Set of 7 pcs)  
Fig #: 560,561,562,563,565,566,567

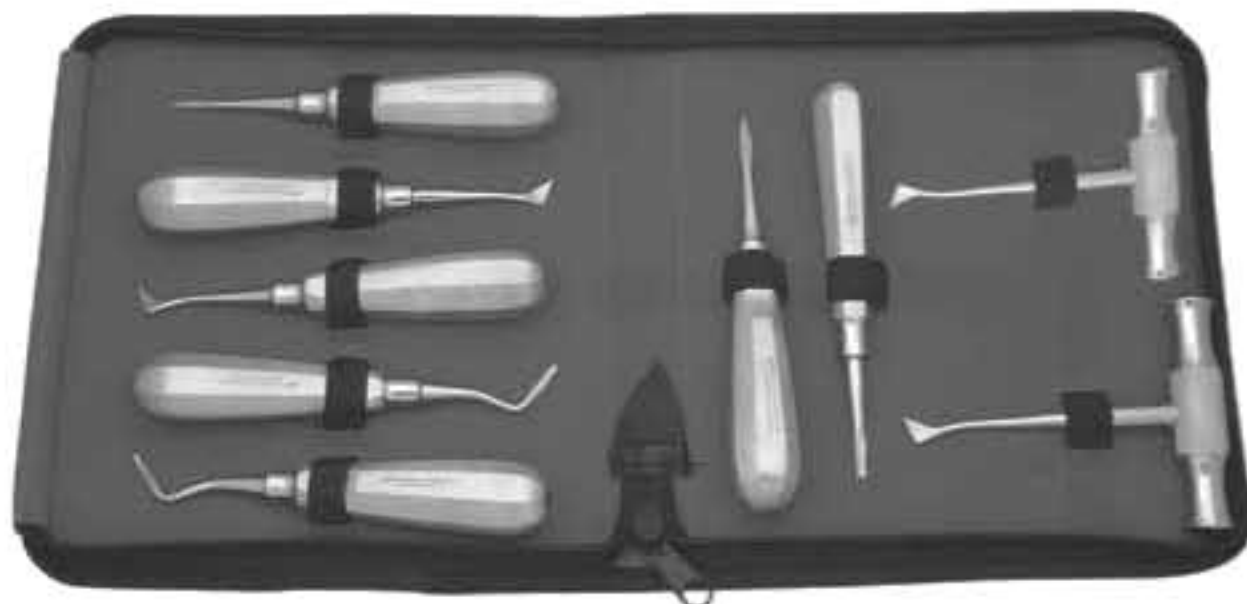

**3255**  
Root Elevators Kit (Set of 9 pcs)  
A) Cross Bar Elevator #775/7  
B) Cross Bar Elevator # 775/8  
C) Elevator, Str. Hospital Pattern (Semi-Pointed)  
D) Elevator-Coupland Back Crurver #2 (Lindoleven)  
E) Elevator # 720/10  
F) Elevator # 120/11  
G) Elevator # 720/27  
H) Elevator # 720/28

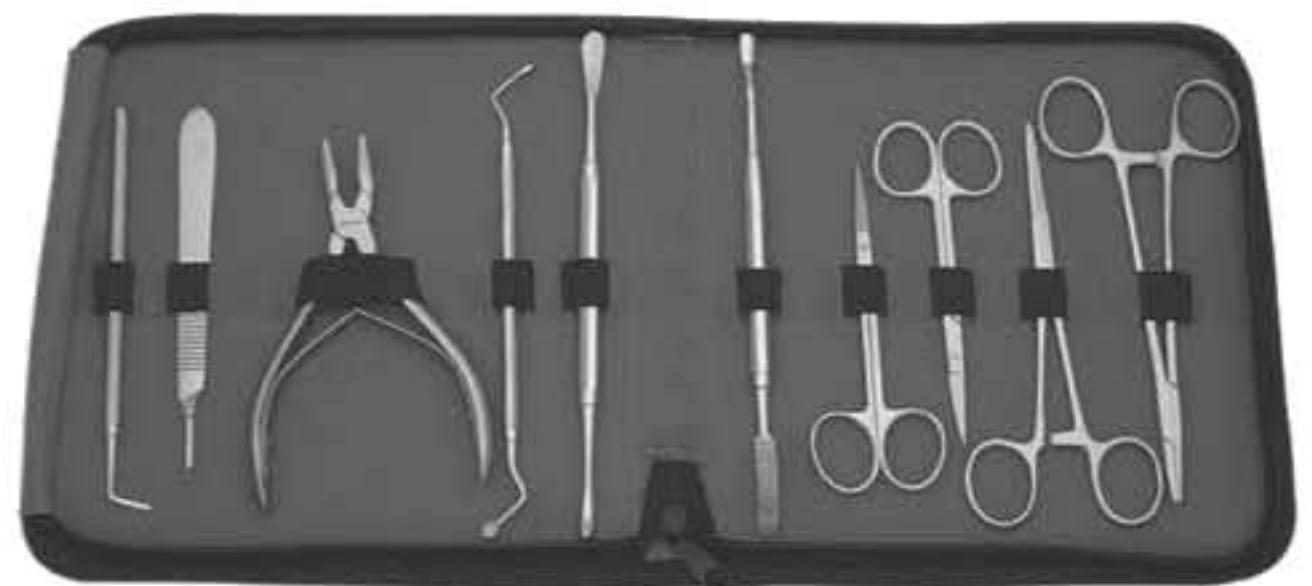

**3256**  
Oral Surgical Instruments Kit  
A) B.P. Handle # 3 - Round, Str.  
B) Artery Forceps, Str. 5.5"  
C) Needle Holder, Str. 6"  
D) Gum Scissors # 1  
E) Gum Scissors # 2  
F) Moons Probe, (Flat Beak)  
G) Bone Curettes # 780 (Lucas)  
H) Bone Nibbler, Large with Hole  
J) Periosteal Elevator



**3257**  
Crown Remover Set  
Full Automatic



**3258**  
Rubber Dam  
Instruments Set



**3259**  
Gracey Curettes, (Set of 8 pcs)  
Fig # 1/2,3/4,5/6,7/8,9/10,  
11/12,13/14,15/16



**3260**  
Subgingival Scalers  
(Set of 8 pcs S/E)



**3261**  
Titanium Coated Filling Instruments  
Hollow Handle (Set of 6 pcs)



**3262**  
Titanium Coated Filling Instruments  
(Set of 6 pcs)



# Alphabetical Index



## A

|                             |         |
|-----------------------------|---------|
| Adams, Pliers               | 174     |
| Aderer, Pliers              | 174     |
| Adson, Forceps              | 158,207 |
| Adson, Tweezers             | 151     |
| Ainsworth, Rubber Dam Punch | 147     |
| Albee                       | 143     |
| Albrecht, Tweezers          | 155     |
| Allen, Tweezers             | 155     |
| Allis, Tissue Forceps       | 158     |
| Amalgam Applicators         | 97      |
| Amalgam Condensers          | 97      |
| Amalgam Pluggers            | 97      |
| Amalgam Carriers            | 145     |
| Amalgam Guns                | 145     |
| Andresen, Pliers            | 175     |
| Andrews, Tongue Depressor   | 160     |
| Angle, Pliers               | 169,174 |
| Apical, Elevator            | 57,63   |
| Arruga, T.C. Needle Holder  | 208,209 |
| Articulators                | 194-195 |
| Aspirating Syringes         | 149     |
| Allen 9A, Elevator          | 50      |

## B

|                                       |         |
|---------------------------------------|---------|
| Baby-Allis, Tissue Forceps            | 158     |
| Band Removing Pliers                  | 170     |
| Bane, Rongeurs                        | 179     |
| Barnhart, Curettes                    | 110,116 |
| Barry, Elevator                       | 66,69   |
| Baum Gartner, Needle Holder           | 180,211 |
| Bee Be, Scissors                      | 186     |
| Bein, Elevator                        | 54,61   |
| Beyer, Rongeurs                       | 179     |
| Bird Beak Pliers                      | 167     |
| Blumenthan, Rongeurs                  | 176     |
| Boley Gauge                           | 143     |
| Bone Curettes                         | 129     |
| Boynton, Needle Holder                | 181     |
| Bozemann-Wertheim, T.C. Needle Holder | 210     |
| Bracket, Pliers                       | 170     |
| Brewer, Rubber Dam Instruments        | 147     |
| Brown, Tissue Forceps                 | 158     |
| Brown-Adson, Tissue Forceps           | 158     |
| Bruns, T.C. Scissors                  | 203     |
| Buchs, Retractor                      | 162     |
| Burnishers                            | 99-100  |
| Ball Chain                            | 146     |
| Boley Gauge,                          | 143     |
| Bone Gauge,                           | 144     |
| Bone Mill Forcep,                     | 139     |
| Bone Pluggers,                        | 140     |
| Bracket, Gauge                        | 144     |
| Buser, Elevator                       | 52      |

## C

|                             |             |
|-----------------------------|-------------|
| Carvers                     | 102,103     |
| Castroviejo, Needle Holder  | 181,208,209 |
| Castroviejo, scissors       | 186         |
| Castroviejo, Gauge          | 144         |
| Castroviejo, Sclerer Marker | 144         |
| Cement Instruments          | 118,119,121 |
| Cement Spatulas             | 120,122     |
| Chisels                     | 103         |
| Chompret, Elevator          | 63          |

|                               |             |
|-------------------------------|-------------|
| Cleveland, Rongeurs           | 177,178     |
| College, Tweezers             | 152,154     |
| Collier, Needle Holder        | 180         |
| Collin, Retractor             | 162         |
| Columbia, Curettes            | 110,111,116 |
| Composite Placement           | 104,105     |
| Con Scodellino, Wax Knives    | 126         |
| Cord Packers                  | 95          |
| Cottle, Scissors              | 184         |
| Coupland, Elevator            | 58          |
| Crane-Kaplan                  | 128         |
| Crile, Forceps                | 157         |
| Crile, Needle Holder          | 181         |
| Crile-Wood, Needle Holder     | 180         |
| Crown Instruments             | 135,136     |
| Crown Removers                | 134,135     |
| Crown Shell, Pliers           | 166         |
| Cryer, Elevator               | 55,58,69    |
| Cushing , T.C. Forceps        | 207         |
| Cushing, Tweezers             | 151         |
| Cushing-Taylor , T.C. Forceps | 207         |

## D

|                              |             |
|------------------------------|-------------|
| De Bakey , T.C. Forceps      | 207         |
| De Bakey, Scissors           | 184,186,206 |
| De Bakey, T.C. Needle Holder | 209         |
| De La Rosa, Pliers           | 169         |
| Deaver, Scissors             | 184         |
| Denhart, Mouth Gag           | 160         |
| Dental Implants Instruments  | 214,216     |
| Dental Instruments Sets      | 217         |
| Derf, Needle Holder          | 180         |
| Disposable Products          | 117         |
| Dr.Sader, Elevator           | 69          |
| Dressing Forceps             | 207         |
| Dean Scissors                | 186,205     |

## E

|                                       |             |
|---------------------------------------|-------------|
| Elevators                             | 51          |
| Endodontic Condensers                 | 86,87       |
| Ernert, Wax Knives                    | 126         |
| Excavators                            | 89-91       |
| Explorers                             | 80-82,91-94 |
| Extracting forceps (American Pattern) | 36-49       |
| Extracting forceps (English Pattern)  | 1-24        |
| Extracting forceps (fitting handle)   | 25-33       |
| Extracting forceps (For Children)     | 34          |

## F

|                                 |         |
|---------------------------------|---------|
| Fahnenstock, Wax Knives         | 126     |
| Files                           | 125     |
| Filling Instruments             | 106,107 |
| Fine, T.C. Scissors             | 206     |
| Finochietto, T.C. Needle Holder | 211     |
| Finochietto, T.C. Needle Holder | 211     |
| Fischer, Pliers                 | 175     |
| Flagg, Tweezers                 | 154     |
| Flohr, Elevator                 | 56      |
| Fomon, Tissue Retractor         | 164     |
| Freer, Elevator                 | 52      |
| Friedman, Rongeurs              | 178     |
| Furrer, Pliers                  | 174     |
| Film Hanger                     | 146     |
| Finger Cup                      | 197     |
| Flohr, Elevator                 | 57      |
| Freer                           | 15,16   |



|                                    |             |  |             |
|------------------------------------|-------------|--|-------------|
| Elevator                           | 52          | Langenbeck, Retractor                  | 162         |
| <b>G</b>                           |             | Langenbeck, T.C. Needle Holder         | 212         |
| Gardner, Bone Chisels              | 132         | Langer, Curettes                       | 110,116     |
| Gardner, Needle Holder             | 180         | Langhals, T.C. Needle Holder           | 212         |
| Gardner, Rongeurs                  | 178         | Lecluse, Elevator                      | 65          |
| Gillies, Hook                      | 164         | Lessmann, Wax Knives                   | 126         |
| Gillies, Tweezers                  | 151         | Lexer, T.C. Scissors                   | 202         |
| Goldman Fox , T.C. Scissors        | 206         | Lichtenberg, T.C. Needle Holder        | 212         |
| Goldman Fox, Curettes              | 112,113     | Ligature , T.C. Scissors               | 207         |
| Goldman Fox 14, Elevator           | 50          | Lip & Cheek Retractors                 | 161,162     |
| Goldman Fox, knives                | 114         | Lister, Scissors                       | 184         |
| Goslee, Pliers                     | 175         | Littauer, Scissors                     | 186         |
| Gracey Curettes                    | 108,109,116 | Little, Scissors                       | 184         |
| <b>H</b>                           |             | Locklin, Scissors                      | 186         |
| Halsey, T.C. Needle Holder         | 209         | London Hospital, Elevator              | 62          |
| Handles                            | 72          | London-College, Tweezers               | 154,155     |
| Hartman, Rongeurs                  | 179         | Lucae, T.C. Forceps                    |             |
| Hatchets                           | 95          | Luehty-Beck, T.C. Needle Holder        | 212         |
| Heaney, T.C. Needle Holder         | 211         | Lwanson, Crown Gauge                   | 143         |
| Hegar, T.C. Needle Holder          | 209         | Lagrange, Scissors                     | 186,205     |
| Hegar-Vascular, T.C. Needle Holder | 209         | Littaure, Scissors                     | 186         |
| Heidbrink, Elevator                | 64,67,69    | Lwanson, Crown Gauge                   | 143         |
| Heidbrink, Elevator                | 57          | <b>M</b>                               |             |
| Howard 9H, Elevator                | 52          | Martin, T.C. Needle Holder             | 210         |
| Height Gauge,                      | 143         | Mathieu, Needle Holder                 | 181,211     |
| Hepp-Scheidle, T.C. Needle Holder  | 208         | Mathieu-Kosher, T.C. Needle Holder     | 211         |
| Hlsted-Mosquito, Forceps           | 159         | Mathieu-Ryder, T.C. Needle Holder      | 212         |
| Hoes                               | 95,125      | Mathieu-Vascular, T.C. Needle Holder   | 211         |
| Hollow Wares                       | 196-200     | Mayo Harrington, T.C. Scissors         | 205         |
| How, Pliers                        | 167,174     | Mayo, Scissors                         | 185,204     |
| Howard, Bone Files                 | 131         | Mayo-Hegar, Needle Holder              | 181         |
| Hyllin, Elevator                   | 61          | Mayo-Hegar, T.C. Needle Holder         | 209         |
| <b>I</b>                           |             | Mayo-Lexer, T.C. Scissors              | 202         |
| Implants Instruments               | 137-141     | Mayo-Stille, T.C. Scissors             | 202         |
| Impression Trays                   | 187-193     | Mayo-Stille Scissors                   | 185         |
| Iris Scissors                      | 183         | Mc Kellops, Pliers                     | 175         |
| Ivory, Rubber Dam Instruments      | 147         | Mccalls, Curettes                      | 110,111,116 |
| <b>J</b>                           |             | Mcindoe, Tweezers                      | 151         |
| Jarabak, Pliers                    | 165         | Mead, Bone Mallets                     | 133         |
| Jeseph, Scissors                   | 183         | Mead, Elevator                         | 64          |
| Johnson, Pliers                    | 169,175     | Mead, Rongeurs                         | 179         |
| Joseph, Tissue Retractor           | 164         | Meriam , T.C. Forceps                  | 207         |
| <b>K</b>                           |             | Meriam, Tweezers                       | 153,155     |
| Kalt, T.C. Needle Holder           | 208         | Metzenbaum Fino, T.C. Scissors         | 203,204     |
| Kelly, Forceps                     | 159         | Metzenbaum, Scissors                   | 185,203     |
| Kelly, Scissors                    | 183         | Micro Surgery Set                      | 182         |
| Kelly Scissors                     | 205         | Micro-Adson, Tweezers                  | 151         |
| Kim's Plier                        | 165         | Micro-Friedman, Rongeurs               | 178         |
| Kirkland, knife                    | 114         | Middledorpf Retractor                  | 162         |
| Knives                             | 125         | Miller, Articulating Forceps           | 147         |
| Knowles, Scissors                  | 184         | Miller, Bone Files                     | 130         |
| Kocher, Retractor                  | 162         | Mini-Blumenthan, Rongeurs              | 176         |
| Kocher-Langenbeck, Retractor       | 162         | Molt, Elevator                         | 50          |
| Kopp, Elevator                     | 60,68       | Molt, Mouth Gag                        | 160         |
| Kopp , Tweezers                    | 151         | Molt 9, Elevator                       | 50          |
| <b>L</b>                           |             | Morrison, Elevator                     | 56          |
| Lab & Office Pliers                | 166         | Mouth Mirrors with Handles             | 73          |
| Landgraf, Tweezers                 | 154         | MSY, Pliers                            | 175         |
| Langenbeck, Pliers                 | 175         | Mullar Claus, Wire Cutting Pliers T.C. | 213         |
|                                    |             | <b>N</b>                               |             |
|                                    |             | Nance, Pliers                          | 168,169,174 |
|                                    |             | Napkin Holders                         | 146         |
|                                    |             | Neivert, Needle Holder                 | 180         |
|                                    |             | Nelson-Metzenbaum, Scissors            | 185         |
|                                    |             | Non Chill                              | 146         |

## O

|                              |     |
|------------------------------|-----|
| O'Brien, Pliers              | 168 |
| Obturation Instruments       | 88  |
| Ochsenbein                   | 128 |
| Ordan, knife                 | 114 |
| Oehler, T.C. Forceps         | 208 |
| Olsen-Hegar, Needle Holder   | 180 |
| Optical Pliers               | 168 |
| Orthodontic Cutters, T.C.    | 172 |
| Orthodontic Distal & Cutters | 173 |
| Orthodontic Pliers, T.C.     | 171 |
| Ott, Elevator                | 62  |

## P

|                                 |             |
|---------------------------------|-------------|
| Parametrium, T.C. Scissors      | 205         |
| Partsch, Bone Chisels           | 133         |
| Partsch, Bone Mallet            | 133         |
| Pean, Forceps                   | 157         |
| Peeso, Pliers                   | 166,175     |
| Peets, Forceps                  | 157         |
| Perry, Tweezers                 | 151         |
| P.K. Thomas,                    | 9696        |
| Pich,                           | 9898        |
| Pluggers,                       | 9898        |
| Prichard, Elevator              | 5050        |
| Plastic Handle Elevators        | 70          |
| Polokoff, Bone File             | 131         |
| Pott, Elevator                  | 51          |
| Potts-Smith, T.C. Forceps       | 208         |
| Potts-Smith, T.C. Needle Holder | 208         |
| Probes                          | 82-85,91,94 |

## Q

|                  |     |
|------------------|-----|
| Quinby, Scissors | 183 |
|------------------|-----|

## R

|                                    |         |
|------------------------------------|---------|
| Ragnell , T.C. Scissors            | 206     |
| Retainers, Bands                   | 146     |
| Reynolds, Pliers                   | 169,174 |
| Root Planning Curettes             | 115     |
| Root splinter forceps              | 35      |
| Roux, Retractor                    | 162     |
| Rubber Dam Clamps                  | 148     |
| Rubber Dam Holder                  | 147     |
| Rule, Curette                      | 110     |
| Russian, Tissue Forceps            | 158     |
| Ryder, T.C. Needle Holder          | 210     |
| Ryder-Vascular, T.C. Needle Holder | 210     |

## S

|                           |          |
|---------------------------|----------|
| Sarot, T.C. Needle Holder | 210      |
| Scalers                   | 75-79    |
| Scalpel Handles           | 71       |
| Schwarz, Pliers           | 168,175  |
| Schluger, File            | 114      |
| Seldin, Elevator          | 50,55,67 |
| Select, Tweezers          | 151      |
| Semken, T.C. Forceps      | 207      |
| Semkin, Tissue Forceps    | 158      |
| Senn, Tissue Retractor    | 164      |
| Separating Pliers         | 166      |
| Sims, T.C. Scissors       | 205      |
| Spatulas                  | 123      |
| Spencer, Scissors         | 186      |
| Spencer-Wells, Forceps    | 157      |

|                               |         |
|-------------------------------|---------|
| Spreaders                     | 87      |
| Split Chisels,                | 128     |
| Spring Bow Divider            | 143     |
| Standard, T.C. Scissors       | 201     |
| Standard, Tweezers            | 151     |
| Steiner, Pliers               | 166     |
| Sterilizing & Lab Instruments | 156     |
| Sterilizing Forceps,          | 163     |
| Stevens, Needle Holder        | 181     |
| Stevens, Scissors             | 183     |
| Stille, Scissors              | 185     |
| Stratte, T.C. Needle Holder   | 210     |
| Strip Holder Clips            | 146     |
| Syringes                      | 150     |
| Suction Tubes,                | 140,142 |
| Sugarman, File                | 114     |

## T

|                                   |     |
|-----------------------------------|-----|
| Toennis, Wire Cutting Pliers T.C. | 213 |
| Toennis-Adson, Scissors           | 184 |
| Toennis, Tissue Retractor         | 164 |
| Towel Clamps, Napkin Holders      | 159 |
| Tweed, Pliers                     | 168 |
| Telescope, Crown Plier            | 136 |
| Traymann, Crown Remover           | 128 |

## U

|                           |     |
|---------------------------|-----|
| Universal , T.C. Scissors | 207 |
| Universal, Pliers         | 174 |
| Universal, Elevator       | 135 |
| Utility Plier             | 165 |

## V

|                                |     |
|--------------------------------|-----|
| Vernier, Measuring Instruments | 143 |
| Vernier Gauge                  | 143 |

## W

|                              |             |
|------------------------------|-------------|
| Wakefield, Bone Chisels      | 132         |
| Waldron, Pliers              | 174         |
| Waldsachs, Pliers            | 174         |
| Wangensteen, T.C. Forceps    | 208         |
| Warwick-James, Elevator      | 62          |
| Waugh, Tweezers              | 151         |
| Wax & Modeling Carvers       | 120         |
| Wax & Plaster Knives         | 127         |
| Wax Carvers                  | 101         |
| Wax, Porcelain Instruments   | 118,119,121 |
| Webster, Needle Holder       | 180,209     |
| Weingart , Utility Pliers    | 167         |
| Weitlaner, Retractor         | 160         |
| West, Elevator               | 50          |
| White, Rubber Dam Instrument | 147         |
| Wieder, Tongue Depressor     | 160         |
| Winter, Elevator             | 65,69       |
| Wire & Clasp Bending Pliers  | 170         |
| Wire Bending Pliers          | 166         |
| West, Elevator               | 50          |
| Wire Cutter                  | 165         |
| Woodson,                     | 98          |

## Y

|               |         |
|---------------|---------|
| Young, Pliers | 168,174 |
|---------------|---------|

## Z

|                                |     |
|--------------------------------|-----|
| Zuricher, Measuring Instrument | 143 |
| Zuricher, Gauge                | 143 |





---

**Address: Roras Road, New Miana Pura  
Sialkot-51340, Pakistan.**

**Phone: +92 -333-866-5278**

**Fax : +92-333-4648200**

**Website : [www.bigline](http://www.bigline)**